



上海山合海融商贸有限公司

Shanghai Shanhe&hairong Commerce Co., Ltd.

Honeywell

霍尼韦尔全系列安全产品目录

- 听力防护系列
- 眼脸部防护系列
- 呼吸防护系列
- 气检测仪系列
- 手部防护系列
- 防护服系列
- 足部防护系列
- 坠落防护系列
- 电力防护系列
- 消防救援系列

山 高水长

海 纳百川

云 **合** 雾集

有 **融** 乃大

西班牙 LIFASA 电容器

台湾 SEW 仪器仪表

美国 salisbury 产品

美国 KUDOS 液压工具

法国 TAG6000 核相器

日本长谷川检电仪器

日本 YS 绝缘防护产品

Suparule 测高仪

带电作业用绝缘产品

张力放线施工设备

液压工具及压接机

压接机等液压工具

充电、手动液压切刀

高低压检电测试仪器

电线电缆处理工具

Q90 空调风量测试仪

高空防坠器、安全带

钢筋角钢铁板加工机

母线切断冲孔弯曲机

美翠 METREL 仪器

美国 Vanguard 仪器

美国 HOLADAY 仪器

TI27 红外热成像仪

国产安全防护产品

代理优势品牌列表



上海山合海融商贸有限公司是立足上海，面向全国，专业从事国产低压电器、安全防护、绝缘产品、仪器仪表、进口产品等产品的生产和销售。本公司自有品牌产品包括：SHPB 过电压保护器、SA2000-JS 过电压在线监测仪；销售商品定位在已有一定知名度的中高档品牌商品上，为客户提供

质优价廉的产品。本公司经营的主要产品包括西班牙 LIFASA 电容器、台湾标准电机 SEW 仪器仪表、美国 salisbury 安全防护产品、日本长谷川 HASEGAWA 检电器、美国 KUDOS 液压工具、美国 FLUKE 热成像仪、法国 TAG6000 核相器、进口专业机具和工具、道尔顿直饮净水器、绝缘靴、绝缘手套、放电棒、操作杆、绝缘毯、验电器信号发生器、验电器、接地线、电阻器、变阻器、断路器、接触器、电磁铁、制动器、熔断器、起动机、电容器、变压器、电压表、调压器、控制器、互感器、电流表、稳压器、继电器、隔离开关、测高仪、金钟穆勒、配电箱、转换开关、刀开关、组合开关、隔离开关、避雷器、按钮信号灯等。

电话(Tel): 021-5108 2245 13818244503

传真(Fax): 021-56889357

网址: <http://www.51082245.com>

E-mail: biz@shhairong.cn

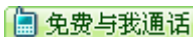



关于我们 | About us

Honeywell

Safety Products

霍尼韦尔安全产品业务部门 (Honeywell Safety Products) 隶属于财富 100 强霍尼韦尔集团旗下的生命安全集团，是全球个人安全防护产品领域最大的供应商之一，服务贯穿于通用工业、消防救援、电力安全等多个领域，满足不同行业对于个人安全防护装备 (PPE) 的不同等级需求，为客户度身定制个人安全防护解决方案。其广为熟知的品牌有斯博瑞安 (Sperian) (Sperian 现正式更名为 Honeywell)、诺斯 (North by Honeywell)、专注坠落防护的 Miller by Honeywell、专注听力防护的 Howard Leight by Honeywell、专注焊接防护 Fibre-Metal by Honeywell、专注足部防护的 Servus by Honeywell、专注电力安全的 Salisbury by Honeywell 以及消防救援领域的专业技术领导者 Honeywell First Responder 等。霍尼韦尔安全产品运用先进的人体工程学设计理念，坚持技术创新，不断改进产品，致力于为人们建立一个更安全、更舒适，更具有创新力和生产力的工作环境。



强强联手



Honeywell Safety Products belongs to Honeywell Life Safety Group by Honeywell, the Fortune 100 company. Honeywell, is one of the leading international manufacturers of Personal Protective Equipment. Honeywell Safety Products specializes in providing PPE solutions for use in all sectors where men and women are at risk during occupational environment (manufacturing, fire fighting, telecommunications, electrical live-line, public services, etc.). The company has united the most respected brands in PPE, Its such as well known brand, such as Sperian (Sperian is now becoming Honeywell), North by Honeywell, Miller by Honeywell (expert in Fall Protection), Howard Leight by Honeywell (expert in Hearing Protection), Salisbury by Honeywell (expert in Electrical Safety Protection) and Honeywell First Responder (expert in Fire & Rescue) to deliver best-in-class safety, quality and performance to a broad range of industries and workers every day. Honeywell Safety Products designs and manufactures use the most complete line of advanced and ergonomic design personal protection solutions to cover the PPE needs of men and women from head-to-toe, insist. Its ongoing innovation, continuous improvement, and continuous commitment to safety helps to build a safer, more comfortable, more innovative and productive work environment.



听力防护系列

Hearing Protection

03	抛弃型耳塞	Disposable Earplugs
04	头箍式耳塞	Banded Earplugs
05	可重复使用耳塞	Reusable Earplugs
06	耳塞分配器	Earplugs Dispensers
07	噪音隔离耳罩系列	Noise Blocking Earmuffs
13	声音管理耳罩系列	Sound Management Earmuffs

眼脸部防护系列

Eye & Face Protection

17	防护帽	Hard Hat
17	防护眼镜	Spectacles
21	护目镜	Goggles
23	防护屏	Faceshield / Visors
25	洗眼器	Eyewash
28	眼镜清洁套装	Clean Kits

呼吸防护系列

Respiratory Protection

31	口罩	Disposable Mask
34	半面罩	Reusable Half Mask
37	全面罩	Reusable Full Face Mask
40	过滤器	Cartridges and Canisters
45	动力送风及长管呼吸系统	PAPR and SAR
55	自给开路式压缩空气呼吸器	SCBA
67	逃生系统	Escape Devices
70	高压气瓶充气泵	Compressor

气检测仪系列

Instrumentation

73	单一气体检测仪	Single-Sensor Gas Monitors
75	多气体检测仪	Multi-Sensor Gas Monitors
79	固定系统	Fixed Systems
80	空气过滤系统	Air Filtration System
81	SCBA 呼吸器检测仪	SCBA Performance Testers
83	IQ Express™ 全自动检测标定仪	IQ Express™ Docking Station

手部防护系列

Protective Gloves

87	通用手套	General Handling
90	防割伤伤害	Cut Resistance
93	防化学类伤害	Chemical Resistance
97	抛弃型手套	Disposable
98	耐高温及焊接类应用	Heat Resistance and Welding Application
102	防冻伤害	Cold Resistance
103	受控环境	Controlled Environment

防护服系列

Protective Clothing

117	避火服	Fire Protective Clothing
119	隔热服	Heat Resistant Clothing
121	重型防化服	Chemical Protective Clothing - Heavy
123	中型防化服	Chemical Protective Clothing - Medium
125	轻型防化服	Chemical Protective Clothing - Light
127	喷砂/焊接防护服	Leather Coverall
128	核污染防护服	Nuclear Protective Clothing

足部防护系列

Foot Protection

133	工业用安全鞋	Industry Safety Shoes
137	安全防护靴	Safety Boots
140	工矿靴	Heavy Duty Boots
140	电力伤害防护靴	EH Protection
141	防寒靴	Cold Resistance
142	消防战斗靴	Fire Fighter

坠落防护系列

Fall Protection

145	风电专用安全带	Wind Energy Harnesses
146	工业用安全带	Harnesses for Industrial Applications
149	特殊用途安全带	Harnesses for Special Applications
150	系绳(带)	Lanyards
154	坠落制动器	Fall Arrest Blocks
160	连接件和附件	Connectors
162	焊接类坠落防护产品	Welding Fall Protection Products
164	救援产品	Rescue Equipment
165	高空防坠落系统	Fall Protection System

电力防护系列

Electrical Safety Protection

171	HRC2电弧防护设备	HRC2 Arc Flash Protection Equipment
172	HRC4电弧防护设备	HRC4 Arc Flash Protection Equipment
173	电工绝缘手套	Insulating Gloves

消防救援系列

First Responder Products

177	头部防护	Head Protection
177	手部防护	Hand Protection
179	身体防护	body Protection
180	足部防护	Foot Protection



抛弃型耳塞	Disposable earplugs	03
可重复使用耳塞	Reusable Earplugs	05
耳塞分配器	Earplugs Dispensers	06
噪音隔离耳罩系列	Noise Blocking Earmuffs	07
声音管理耳罩系列	Sound Management Earmuffs	13

选择正确的耳塞 才能真正保护您的听力!

适合

为每个不同的耳道找到不同形状和尺寸的产品并不是那么困难。一个适合的耳塞应该在保持应有的防护的同时让佩戴者的耳道感到舒适。Honeywell耳塞因其先进的设计和材料科技为每一个作业者提供 适当的防护。

选择

为什么有这么多的耳塞? 因为人和人所处的环境都非常的的不同。Honeywell提供了 全的产品选择去适应各种不同的环境

选择听力防护产品的原则: 在正确选择与佩戴的前提下, 所选听力防护产品的NRR=现场噪声分贝值-法律规定限值(85dB)

举例: 某工厂车间经检测分贝值达到115分贝, 而法律规定的工作环境噪音限制为85分贝, 所以该车间的工人可选择耳塞或耳罩的NRR至少为115-85=30, 并且使用正确的佩戴方法。

防护

听力防护产品只有在人们使用它的时候才有用。Honeywell提供了一系列不同NRR值的耳塞产品, 在不影响员工工作的同时提供听力防护。

NRR是用来标定听力防护用具所能提供的降噪等级。

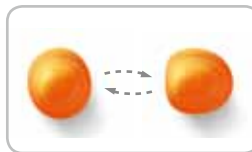

CMT是一种用户友好技术
SmartFit 耳塞可以根据人体自身的温度调节大小以适合佩戴者的耳道。



聚氨酯发泡耳塞
我们专利技术的开放式聚氨酯材料在一次性发泡耳塞的应用, 使其在不降低防护效率的同时又能佩戴舒适。



不同形状
为了给每一个耳朵提供适合的耳塞, Honeywell提供了不同形状的耳塞供不同的佩戴者选择。

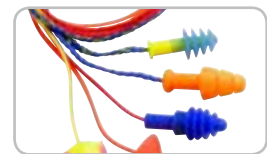

带线选择
在很多工作环境, 工作者需要在工作的時候取下耳塞。带线耳塞的设计让摘取和佩戴耳塞变得十分容易。

标准		雇主的职责		声音强度水平标	
EN 352/1	头箍	雇员应佩戴听力防护装备	恒定噪音	波动噪音	
EN 352/2	耳塞		85dB*	137dB	
EN 352/3	装在头盔上的头箍	雇员应配备听力防护装备	80dB	135dB	
EN 352/4	电子头箍				
EN 458	选择、使用、听力防护装备使用注意事项和维护等建议的指导资料				
		2003年2月15日欧盟政府公报上发表的欧洲指令 2003/10/EC			
		*dB: 分贝			

抛弃型耳塞

Disposable earplugs

同时提供带线及不带线两种选择

子弹型耳塞中的C舒适设计
Energized for personal
comfort and performance

NRR29



订货号: 1000106 大号 带线
1005073 大号 不带线
1000107 小号 带线
1005074 小号 不带线

Bilsom 303

频率 (赫兹) Frequency/Hz	125	250	500	1000	2000	3150	4000	6300	8000
平均衰减(分贝) Mean Attn.(dB)	34.4	35	36.2	35.9	36.4	38.9	39.8	42.6	43
标准偏差(分贝) Std. Dev.(dB)	3.4	4.2	3.8	3.0	2.9	3.0	3.2	4.2	4.1

结合专利技术和优异的制造工艺, Bilsom 303防噪音耳塞更贴合耳道, 能够改善长时间配戴的舒适度——适合每个人使用。典型的子弹头型耳塞在塞入耳道后, 由于在塞入过程中发泡迅速膨胀, 耳塞容易从耳道中脱出。基于我们在材料科学方面的专业知识, Bilsom 300耳塞的新型聚胺酯发泡配方更容易塞入, 且一旦正确塞入后, 可防止耳塞从耳道滑出——确保 佳的贴合保护。该耳塞表面光滑、抗污垢, 可以防止耳塞堆积污垢。

Incorporating patented technology and manufacturing excellence, the energized Bilsom 303 features a better fit in the ear canal and an increased comfort over long periods of time – everyone benefits!

Typical bullet-shaped earplugs have a tendency to back out of the ear canal due to fast foam expansion during insertion. Utilizing our material science expertise, the Bilsom 303's new polyurethane foam formulation is easier to roll-down and, once inserted properly, resists the tendency to back out of the ear canal – ensuring a tight seal of optimal protection. Its smooth, soil-resistant skin prevents the build-up of dirt on the earplug, promoting proper hygiene. Plus, two sizes [regular, small] ensure a personalized fit for each employee.

高防护的抛弃型发泡耳塞
Highest NRR in Disposable
Foam Earplug

NRR33



钟型

订货号: MAX-30 带线
MAX-1 不带线

Max®

频率 (赫兹) Frequency/Hz	125	250	500	1000	2000	3150	4000	6300	8000
平均衰减(分贝) Mean Attn.(dB)	40.9	43.0	44.8	38.9	37.2	47.4	48.5	47.7	47.8
标准偏差(分贝) Std. Dev.(dB)	3.5	3.9	3.8	2.8	2.7	4.5	3.1	4.4	3.9

Bilsom 303

根据大量的Honeywell研发部门的分析研究, 我们发现对子弹型耳塞来说:

- 在手中摸起来很柔软的发泡耳塞, 可能在耳道中产生的压力比硬耳塞更大。
- 快速恢复的发泡耳塞在耳道中施加的压力较小, 但是在塞入时, 未贴合前便已经恢复原型。
- 理想的发泡耳塞应当介于以上两者之间。
- Bilsom 303 耳塞便是这一理想特性的完美结合。

结合专利技术和优异的制造工艺, Bilsom 303防噪音耳塞更贴合耳道, 能够改善长时间配戴的舒适度——适合每个人使用。

- Foam that is very soft to the touch in the hand may exert pressure in the ear canal than a hard earplug
- A fast-recovering foam earplug exerts less pressure in the ear canal, and recovers back to its original shape before being properly fitted into the ear canal
- The ideal foam earplug sits in the middle of both of these ranges
- The energized Bilsom 303 Energized earplug matches this ideal combination of measurable features!

Max®

- 全球使用广泛的PU发泡耳塞
- 钟型设计, 保证了佩戴的舒适度
- 经过改进的外形设计, 佩戴更加方便, 并且不易脱落
- 光滑的耳塞表面, 抗油性的设计, 可防止污垢累积
- PU发泡耳塞增强佩戴舒适性, 特别是长时间佩戴
- The world's most-used polyurethane earplug
- Bell shape delivers maximum in-ear comfort
- Improved design, easier to insert, reduces tendency to back out of ear
- Smooth, soil-resistant skin prevents dirt build-up
- Polyurethane foam enhances comfort, especially for long-term wear

舒适，小号设计 Comfort for Smaller wearers

NRR30



订货号: LPF-1-O-CH 不带线
LPF-30-O-CH 带线

Max-Lite®

频率 (赫兹) Frequency/Hz	125	250	500	1000	2000	3150	4000	6300	8000
平均衰减 (分贝) Mean Attn.(dB)	33.5	33.6	36.0	37.5	39.4	42.5	43.9	43.7	45.2
标准偏差 (分贝) Std. Dev.(dB)	3.6	3.4	3.2	3.5	3.5	3.4	5.1	4.8	5.1

Max-Lite®

- 适合耳道稍小的人群使用
- 低压发泡设计，佩戴非常舒适，适合长久佩戴
- T型结构设计，佩戴及把握更加方便
- 光滑防油污无孔发泡耳塞表面，防止污垢累积
- Comfort for smaller wearers, Ideal size for female workers
- Low pressure foam expands gently for comfortable long-term wear
- Contoured T-shape for easy handling and wear
- Smooth, soil-resistant closed cell-foam skin prevents dirt build-up

鲜明的颜色设计 The bright idea in protection

NRR32



订货号: LL-30 带线
LL-1 不带线

Laser Lite®

频率 (赫兹) Frequency/Hz	125	250	500	1000	2000	3150	4000	6300	8000
平均衰减 (分贝) Mean Attn.(dB)	36.8	38.0	40.4	41.1	40.1	44.4	48.5	46.4	45.8
标准偏差 (分贝) Std. Dev.(dB)	4	4.5	5.5	4	2.7	4.5	4.1	5.4	5.2

Laser Lite®

- 鲜明的耳塞颜色，使佩戴的耳塞更易察觉，同时增加佩戴乐趣
- 柔软的耳塞能自动调整，使耳塞更加贴合耳道，佩戴非常舒适
- T型耳塞设计，使佩戴和摘取更加简便
- 光滑防油污无孔发泡耳塞表面，防止污垢累积
- Vibrant colors make protection visible and fun
- Self-adjusting foam expands to fit virtually every wearer
- Contoured T-shape for easy insertion and wear
- Smooth, soil-resistant closed cell-foam skin prevents dirt build-up

无需揉搓便可方便佩戴 No-roll design makes insertion fast and easy

NRR23



订货号: MTX-30-OR 带线
MTX-1-OR 不带线

Matrix™

频率 (赫兹) Frequency/Hz	125	250	500	1000	2000	3150	4000	6300	8000
平均衰减 (分贝) Mean Attn.(dB)	31.4	34.3	38.3	34.5	36.0	40.3	39.2	40.9	44
标准偏差 (分贝) Std. Dev.(dB)	3.6	4	3.9	3.0	2.7	3.4	3.1	3.5	3.4

Matrix™

- 专利注册产品，无需揉搓便可方便佩戴
- 光滑表面设计，缩小耳塞直径，适合长时间佩戴
- 快速的插入耳道便可提供优异的防护效果，无需等耳塞发泡弹起
- 独特的降噪效果，在优异的噪声阻隔同时，可更自然的听到人声沟通
- 三种不同的款式提供不同等级的防护
- No-roll insertion
- Patented insert design makes insertion fast and easy
- Smooth out skin and reduced diameter provide long term comfort
- Instant protection and upon proper insertion – no need to wait for foam to expand
- Uniform attenuation profile blocks out noises while voice frequencies can be heard more naturally

可重复使用耳塞 Reusable Earplugs

管体柔软，佩戴快速方便
Patented “no-roll” design for easy handling and comfortable fit

NRR26



订货号: QD30 带线



钟型

Quiet®

频率 (赫兹) Frequency/Hz	125	250	500	1000	2000	3150	4000	6300	8000
平均衰减(分贝) Mean Attn.(dB)	26.3	29.0	28.7	31.2	363.3	44.0	45.1	49.1	47.2
标准偏差(分贝) Std. Dev.(dB)	3.3	2.6	2.8	2.5	3.9	3.6	4.4	4.4	3.7

Quiet®

- 无需揉搓设计，方便佩戴
- 增强的外形设计更贴合耳道
- 表面光滑，对皮肤无刺激
- Patented “no-roll” design is easy to handle and fit
- Contoured shape comfortably matches contours of the ear canal
- Smooth, non-irritating skin provides all-day comfort, easy to clean for long-term use
- Built-in insertion stem makes insertion quick and easy

优异的防护，佩戴舒适
Total protection, Comfort and fit

NRR27



订货号: FUS30 大号 带线

FUS30S 小号 带线 绿 green



圣诞树型

Fusion®

频率 (赫兹) Frequency/Hz	125	250	500	1000	2000	3150	4000	6300	8000
平均衰减(分贝) Mean Attn.(dB)	29.5	29.9	32.3	33.9	37.3	41.1	42.7	47.9	47.6
标准偏差(分贝) Std. Dev.(dB)	4.6	3.7	2.8	2.8	4.1	3.6	4.6	4.8	3.2

Fusion®

- 专利双材料设计，使得耳塞有方便拿捏佩戴的核心柱，以及提供佩戴舒适的柔软侧翼
- FlexiFirm®核心柱方便拿捏，确保便捷的佩戴
- SoftFlange™创造了舒适的耳道封闭，提供舒适的保护
- 独特的可拆卸尼龙耳塞线
- 双尺寸设计，提供个性化佩戴舒适
- 带HearPack耳塞盒
- Patented dual material design combines firm core for easy handling with soft flanges for comfort and fit
- FlexiFirm® stem is easy to grasp, ensuring easy insertion into the ear canal
- SoftFlange™ creates comfortable seal in the ear canal for superior comfort and protection
- Unique detachable nylon cord system adapts to virtually any application
- Two sizes fine-tune fit for personal comfort and safety

个性化耳塞的一次革命
Revolution in personalized fit

NRR 25



订货号: SMF-30 带线



圣诞树型

SmartFit®

频率 (赫兹) Frequency/Hz	125	250	500	1000	2000	3150	4000	6300	8000
平均衰减(分贝) Mean Attn.(dB)	29.5	28	30.5	31.6	33.5	40.5	40.0	41.8	42.1
标准偏差(分贝) Std. Dev.(dB)	3.5	4.1	3.6	3.2	3.5	3.3	4.2	5.3	4.7

SmartFit®

- 专利舒适材料技术，利用佩戴者体温逐渐改变耳塞外形，直到完美贴合耳道
- 佩戴极其舒适，是真正个性化的耳塞
- 一个型号，方便库存管理
- 独特的可拆卸尼龙耳塞线
- 带HearPack®耳塞盒
- Patented Conforming Material Technology™ uses body heat to adapt to the individual shape of each wearer's ear canal
- Delivers superior comfort and a truly individual fit
- Simplifies inventory control – a single product fits almost every wearer
- Detachable cord system and HearPack® storage case

耳塞分配器 Earplugs Dispensers



订货号 Ref.: LS-400

LS 400 经济型轻质耳塞分配器 LS 400 Leight® Source Dispenser

- 产品选用坚硬的耐用塑料制成，轻便经济设计
- 产品除了可以挂在墙也可放在桌面，使用更加便利
- 旋转耳塞分配旋钮，单手操作，使用方便
- 配有接盘，可以防止耳塞掉落地面
- 每次可添加400副耳塞

New Versatile Earplug Dispenser

- Durable plastic design an economical choice for dispensing earplugs
- Mounts to wall or stands as table-top dispenser with balanced footing
- Twist knob to dispense earplugs
- Catch basin prevents earplugs from falling to the ground
- Holds 400 pairs of earplugs



订货号 Ref.: LS-500

LS 500 耐用型金属耳塞分配器 LS 500 Leight® Source Dispenser

- 使用全铝结构设计制造，镀以颜色，适合长久使用。
- 可固定在墙上，方便使用
- 摇柄式耳塞分配设计，使用简便
- 每次可使用内含500副耳塞的填充盒
- Permanent Hearing Protection Source
- Heavy-duty anodized aluminum construction withstands constant use
- Mount on wall for easy access
- Crank handle to dispense earplugs
- Ideal for large factories and process industries that have zero tolerance for packaging waste
- Holds 500 pair of earplugs

可选用耳塞	耳塞描述	订货号	包装
LS-400 Max	耳塞填充包，内含散装 200 副 MAX 抛弃型耳塞	MAX-LS4	200 副/包，10 包/箱
Laser Lite	耳塞填充包，内含散装 200 副 Laser Lite 抛弃型耳塞	LL-LS4	200 副/包，10 包/箱
Bilsom 303	耳塞填充包，内含散装 200 副 Bilsom 303 抛弃型耳塞	10 061 87	200 副/盒，10 包/箱
LS-500 Max	耳塞填充盒，内含散装 500 副 MAX 可重复使用耳塞	MAX-1-D	500 副/盒，4 盒/箱
Max Lite	耳塞填充盒，内含散装 500 副 MAX Lite 可重复使用耳塞	LPF-1-D	500 副/盒，4 盒/箱
Matrix	耳塞填充盒，内含散装 500 副 Matrix 可重复使用耳塞	MTX-1-OR-D	500 副/盒，4 盒/箱
Bilsom 303	耳塞填充盒，内含散装 500 副 Bilsom 303 可重复使用耳塞	10 175 74	500 副/盒，4 盒/箱

噪声隔离耳罩系列

Noise Blocking Earmuffs

在你需要隔绝噪声的时候，我们提供给你有效工作的工具，从大的降噪值保护到高的性价比产品。我们Leightning[®]，Thunder[®]，Viking[™]，Mach[™]系列给不同作业环境下的工人提供理想的听力保护。

When you need to block noise, Honeywell gives you the tools to do the job right. From maximum attenuation to maximum value, we set the standard for noise blocking and hearing protection. Our and QM24+[®] series earmuffs provide a choice of features and protection ideal for many workers and environment.

气流控制技术

Air Flow Control Technology [AFC]

气流控制技术是一个专为在传统耳罩中常见的问题所发明的解决方案。他们的降噪效果在高频波段很好，而在低频的波段就不太好。因此，传统耳罩不能为高强度的低频噪音提供最优的整体防护效果。[AFC]却可以在不增加耳罩尺寸和重量的前提下提供优良的低频降噪效果，从而使降噪效果在整个频率范围内的持续良好。事实上，整体降噪效果的提升就是因为增加了低频降噪效果！

比较其他的耳罩，拥有AFC的耳罩能提供更好低频降噪率的同时也维持良好的高频降噪率。通过下表就可以看出变化：

像[AFC]这样的创新技术帮助鼓励工人更加愿意长时间的佩戴自己的耳罩，使用者得到更好的防护，却不需要一个更大更重的耳罩。

Frequency in Hz	1252	50	5001	000	20003	150	4000	6300	8000	NRR
T2 without AFC1	6.8	20.23	1.8	0.33	8.1	39.43	8.14	0.14	1.8	26
T2 with AFC	22.32	8.1	34.73	7.2	36.2	36.8	36.8	38.8	38.8	28

Air Flow Control [AFC] is the solution to a problem typically seen with traditional earmuffs – they attenuate very well in high frequencies, but poorly in the low frequencies. Thus, traditional earmuffs do not provide optimal overall protection for environments with high levels of low-frequency noise. AFC delivers superior low-frequency attenuation and performs more consistently across the whole frequency range without increasing the size or weight of the earmuff. In fact, overall attenuation improves because of the better low-frequency attenuation!

Compared to other earmuffs, earmuffs with AFC provide better low-frequency attenuation, while maintaining superior high-frequency attenuation. The result is a better overall attenuation, especially in slimline and medium-sized earmuffs. Table 1 shows how AFC boosts the NRR of the Bilsom[®] Thunder[®] T2 earmuff from 26 to 28, with a significant increase in attenuation in the 125–500 frequencies. (Table 1.)

Innovations such as Air Flow Control help to encourage workers to wear their earmuffs on the job and achieve 100% wear-time. Users gain significantly more protection from hazardous low-frequency noise, without any increase in size or weight of the earmuff.

Leightning 耳罩系列 Leightning Earmuffs

大的舒适度和保护效果AFC技术设计
With Air Flow Control™ technology

- 坚固的金属环头箍结构，经得起恶劣环境的高要求考验
- 专利的空气控制技术提供了 优的声音衰减效果
- 多种声音衰减值可选
- 专利发泡棉头带提供长时间佩戴舒适度，小化的头部压力
- Robust steel wire construction withstands demanding use, especially in tough environments
- Feature patented Air Flow Control technology for optimal attenuation
- Multiple attenuation allow for targeted attenuation for a variety of applications
- Padded foam headband delivers long-wearing comfort with minimal pressure on the head

L3



头带型 Headband - L1,L2,L3

- 柔软舒适，内附海绵的头带，长久佩戴更加舒适
- 可伸缩调节高度同时又确保在使用时能很好的固定
- Padded foam headband delivers superb comfort with minimum pressure on the head
- Telescopic height adjustment remains fixed during use

订货号 Ref.

- * 10 109 24 L3 30 NRR
- 10 109 23 L2 27 NRR
- 10 109 22 L1 25 NRR

Leightning® L1

NRR 25

频率 (赫兹) Frequency/Hz	125	250	500	1000	2000	3150	4000	6300	8000
平均衰减 (分贝) Mean Attn.(dB)	19.7	23.8	29.0	31.3	32.1	37.8	39.2	39.5	39.5
标准偏差 (分贝) Std. Dev.(dB)	2.6	2.9	2.6	2.5	2.4	3.1	2.0	2.3	2.4

Leightning® L2

NRR 27

频率 (赫兹) Frequency/Hz	125	250	500	1000	2000	3150	4000	6300	8000
平均衰减 (分贝) Mean Attn.(dB)	21.8	26.6	31.8	35.2	32.9	37.7	37.6	39.1	39.6
标准偏差 (分贝) Std. Dev.(dB)	3.2	3.1	2.5	2.1	2.1	2.4	2.2	2.4	2.6

Leightning® L3

NRR 30

频率 (赫兹) Frequency/Hz	125	250	500	1000	2000	3150	4000	6300	8000
平均衰减 (分贝) Mean Attn.(dB)	23.8	28.8	36.5	39.9	35.3	38.7	39.0	41.0	40.8
标准偏差 (分贝) Std. Dev.(dB)	2.2	2.3	2.4	1.9	2.3	2.8	2.1	2.4	2.3

L2F



折叠型 Folding - L2F

- 折叠后便于储藏和携带
- Convenient folding design for easy storage

订货号 Ref.

- 10 119 97 L2F 27 NRR

Leightning® L2F

频率 (赫兹) Frequency/Hz	125	250	500	1000	2000	3150	4000	6300	8000
平均衰减 (分贝) Mean Attn.(dB)	21.5	26.8	31.8	34.7	32.0	37.7	37.5	38.6	39.9
标准偏差 (分贝) Std. Dev.(dB)	2.9	2.6	2.5	1.9	2.1	2.8	2.5	2.4	2.8

L3H



订货号 Ref.		
* 10 119 93	L3H	27 NRR
10 119 92	L2H	25 NRR
10 119 91	L1H	23 NRR

配帽型 Cap-mounted - LH,L2H,L3H

- 可与多种安全帽配备使用
- 不用时可将耳罩翻起，扣于帽上
- For use with wide range of popular hard hats
- Earcups snap in place during use and swing back when not in use

Leightning® L1H		NRR 23									
频率 (赫兹) Frequency/Hz		125	250	500	1000	2000	3150	4000	6300	8000	
平均衰减 (分贝) Mean Attn.(dB)		20.0	22.4	26.9	29.6	32.1	36.4	37.4	40.2	39.6	
标准偏差 (分贝) Std. Dev.(dB)		2.9	3.4	2.8	2.2	2.8	3.3	2.9	3.7	4.9	
Leightning® L2H		NRR 25									
频率 (赫兹) Frequency/Hz		125	250	500	1000	2000	3150	4000	6300	8000	
平均衰减 (分贝) Mean Attn.(dB)		20.0	25.1	30.5	32.6	32.6	37.8	36.5	38.3	39.7	
标准偏差 (分贝) Std. Dev.(dB)		3.0	2.5	2.6	2.4	2.5	2.4	2.7	3.4	4.0	
Leightning® L3H		NRR 27									
频率 (赫兹) Frequency/Hz		125	250	500	1000	2000	3150	4000	6300	8000	
平均衰减 (分贝) Mean Attn.(dB)		22.5	26.5	34.2	36.9	33.6	36.8	37.3	40.4	37.7	
标准偏差 (分贝) Std. Dev.(dB)		3.4	2.5	3.4	3.2	2.4	3.0	2.9	1.9	2.8	

L3N



订货号 Ref.		
10 119 96	L3N	28 NRR
10 119 95	L2N	26 NRR
10 119 94	L1N	25 NRR

颈带型 Neckband - L1N,L2N,L3N

- 金属环位于颈后
- 可与面屏，安全帽等配合使用
- Metal belt around neck
- Can be used with all kinds of safety hats

Leightning® L1N		NRR 25									
频率 (赫兹) Frequency/Hz		125	250	500	1000	2000	3150	4000	6300	8000	
平均衰减 (分贝) Mean Attn.(dB)		19.3	23.3	28.9	33.2	32.0	36.2	37.3	38.2	38.5	
标准偏差 (分贝) Std. Dev.(dB)		2.6	2.4	2.9	2.0	2.2	2.9	2.7	2.9	2.8	
Leightning® L2N		NRR 26									
频率 (赫兹) Frequency/Hz		125	250	500	1000	2000	3150	4000	6300	8000	
平均衰减 (分贝) Mean Attn.(dB)		20.4	25.3	31.2	35.0	33.2	37.7	37.7	38.9	39.4	
标准偏差 (分贝) Std. Dev.(dB)		3.4	2.9	2.7	2.2	2.5	3.2	2.2	2.3	2.7	
Leightning® L3N		NRR 28									
频率 (赫兹) Frequency/Hz		125	250	500	1000	2000	3150	4000	6300	8000	
平均衰减 (分贝) Mean Attn.(dB)		22.5	27.8	33.7	37.1	33.7	38.5	38.6	40.8	40.3	
标准偏差 (分贝) Std. Dev.(dB)		3.3	2.6	2.9	2.7	2.1	2.7	2.7	2.3	2.6	

Thunder 耳罩系列 Thunder Earmuffs

高的保护效果AFC技术设计
With Air Flow Control™ technology

- 绝缘设计可用于电力环境
- 专利的空气控制技术提供了 优的声音衰减效果
- 多节式可调节头带确保在使用时能很好的固定
- 单元式的耳罩垫更换快捷方便
- Dielectric construction suitable for all workplaces, especially electrical environments
- Feature patented Air Flow Control technology for optimal attenuation
- Quick click height adjustment remains fixed during wear
- Snap-in ear cushions make replacement quick and easy

T3



头带型 Headband - T1,T2,T3

- 柔软舒适，内附海绵的头带，长久佩带更加舒适
- 可伸缩调节高度同时又确保在使用时能很好的固定
- Padded foam headband delivers superb comfort with minimum pressure on the head
- Telescopic height adjustment remains fixed during use

订货号 Ref.
10 109 70
10 109 29
* 10 109 28

T3 30 NRR
T2 28 NRR 绿 green
T1 26 NRR 绿 green

Thunder® T1		NRR 26									
频率 (赫兹) Frequency/Hz		125	250	500	1000	2000	3150	4000	6300	8000	
平均衰减 (分贝) Mean Attn.(dB)	19.1	25.0	30.4	33.5	35.1	35.5	35.6	39.5	39.4		
标准偏差 (分贝) Std. Dev.(dB)	2.9	2.3	2.5	2.5	2.7	3.2	3.0	2.3	3.6		
Thunder® T2		NRR 28									
频率 (赫兹) Frequency/Hz		125	250	500	1000	2000	3150	4000	6300	8000	
平均衰减 (分贝) Mean Attn.(dB)	22.3	28.1	34.7	37.2	36.2	36.8	36.8	38.8	38.8		
标准偏差 (分贝) Std. Dev.(dB)	2.8	3.3	2.6	2.9	2.5	3.1	2.7	2.7	2.6		
Thunder® T3		NRR 30									
频率 (赫兹) Frequency/Hz		125	250	500	1000	2000	3150	4000	6300	8000	
平均衰减 (分贝) Mean Attn.(dB)	24.7	29.8	35.5	38.5	37.9	39.6	39.6	41.9	42.3		
标准偏差 (分贝) Std. Dev.(dB)	2.8	2.7	2.8	3.0	2.5	3.1	2.4	2.6	2.4		

T1F



折叠型 Folding - T1F

- 折叠后便于储藏和携带
- Convenient folding design for easy storage

订货号 Ref.
10 116 00

T1F 25 NRR

Thunder® T1F		NRR 25									
频率 (赫兹) Frequency/Hz		125	250	500	1000	2000	3150	4000	6300	8000	
平均衰减 (分贝) Mean Attn.(dB)	19.6	23.2	29.6	32.6	33.6	34.7	36.3	39.8	38.3		
标准偏差 (分贝) Std. Dev.(dB)	3.4	2.1	3.0	2.4	2.8	2.7	2.9	2.2	4.2		

T3H



配帽型 Cap-mounted - T1H, T2H, T3H

- 可与多种安全帽配备使用
- 不用时可将耳罩翻起，扣与帽上
- For use with wide range of popular hard hats
- Earcups snap in place during use and swing back when not in use

订货号 Ref.

10 116 03 **T3H** 27 NRR
 * 10 116 02 **T2H** 25 NRR 绿 green
 10 116 01 **T1H** 23 NRR 绿 green

Thunder® T1H

NRR 23

频率 (赫兹) Frequency/Hz	125	250	500	1000	2000	3150	4000	6300	8000
平均衰减 (分贝) Mean Attn.(dB)	16.9	22.0	28.4	31.6	33.1	33.7	34.7	39.6	38.6
标准偏差 (分贝) Std. Dev.(dB)	3.6	2.9	3.4	2.9	3.1	2.8	3.0	2.7	4.0

Thunder® T2H

NRR 25

频率 (赫兹) Frequency/Hz	125	250	500	1000	2000	3150	4000	6300	8000
平均衰减 (分贝) Mean Attn.(dB)	20.7	26.9	31.6	34.1	34.9	35.2	36.6	39.4	39.6
标准偏差 (分贝) Std. Dev.(dB)	3.5	3.8	3.7	3.7	3.5	3.3	3.2	2.4	3.5

Thunder® T3H

NRR 27

频率 (赫兹) Frequency/Hz	125	250	500	1000	2000	3150	4000	6300	8000
平均衰减 (分贝) Mean Attn.(dB)	23.6	27.7	34.1	34.5	32.9	36.4	39.1	40.6	41.4
标准偏差 (分贝) Std. Dev.(dB)	3.3	3.4	3.1	1.8	2.0	2.6	3.0	3.1	2.8

Mach 耳罩系列

Mach Earmuffs

- 经济型设计为多种工作环境提供简单方便的防护
- Economical design delivers adequate protection at a low cost
- C 轻便设计提供全天的舒适
- Extremely lightweight construction provides all-day comfort
- 绝缘设计可用于电力环境
- Dielectric construction suitable for all workplaces, especially electrical environments

Mach 1



Mach™ 系列耳罩

- 经济型产品，为多种环境下的噪声环境提供简单方便的防护
- Economical protection for short-term use
- Economical design provides adequate protection at a low cost
- Extremely lightweight construction provides comfort for all-day wear
- Dielectric construction suitable for all workplaces, especially electrical environments

订货号 Ref.

* 10 104 21 Mach 1 18 NRR

Mach™

NRR 18

频率 (赫兹) Frequency/Hz	125	250	500	1000	2000	3150	4000	6300	8000
平均衰减 (分贝) Mean Attn.(dB)	9.3	14.5	23.2	29.6	30.9	31.5	31.7	31.5	31.9
标准偏差 (分贝) Std. Dev.(dB)	3.2	2.6	2.8	3.2	3.0	3.0	2.9	3.2	2.8

Viking 耳罩系列 Viking Earmuffs

- 多向头带，使用者可将头带放在头的前部，上部或者颈部
- 可作为配帽型耳罩的替代品
- 内部通风头带 小化头部压力，在温热潮湿的环境佩带舒适
- 不变形头带外壳适合各种恶劣环境
- 单元式的耳罩垫更换快捷方便
- 伸缩头带能在佩带于头后部和下巴下时更好的固定
- 绝缘设计可用于电力环境
- Multiple-position headband allows wearer to select position over-the-head, behind-the-head or under-the-chin
- Alternative to cap-mounted earmuffs- wear with hard hats, face shields respirators and other PPE
- Inner-ventilated headband minimized pressure on the head, breathes easier in warm/humid climates
- Non-deforming outer headband withstands rough treatment in the toughest workplaces
- Snap-in ear cushions make replacement quick and easy
- Dielectric construction suitable for all workplaces, especially electrical environments
- Includes attached elastic headband strap for better positioning when worn behind-the-head or under-the-chin



V3

Viking™ 系列耳罩

- 多向头带，使用者可将头带位于头的前部，上部或后部
- 可做配帽型耳罩的替代品
- Multiple-position headband allows wearer to select position
- Alternative to cap-mounted earmuffs
- Non-deforming outer headband withstands rough treatment in the toughest workplaces
- Includes headband strap for better positioning when worn behind-the head or under-the-chin

订货号 Ref.	型号	NRR
* 10 109 27	V3	29
10 109 26	V2	27
10 109 25	V1	25

多向头带式设计 Multiple-position headband

Viking™ V1		NRR 23			Over-the-Head					
频率 (赫兹) Frequency/Hz		125	250	500	1000	2000	3150	4000	6300	8000
平均衰减 (分贝) Mean Attn.(dB)		14.1	21.9	28.0	32.4	34.2	35.4	35.7	37.2	36.7
标准偏差 (分贝) Std. Dev.(dB)		2.5	3.2	3.1	2.6	3.4	2.6	2.5	4.5	3.7
Viking™ V2		NRR 22			Behind-the-Head					
平均衰减 (分贝) Mean Attn.(dB)		12.5	19.1	27.1	31.2	34.5	36.4	35.4	37.1	37.9
标准偏差 (分贝) Std. Dev.(dB)		2.5	3.3	2.7	2.2	3.7	2.6	1.9	2.8	2.9
Viking™ V2		NRR 22			Under-the-Chin					
平均衰减 (分贝) Mean Attn.(dB)		12.3	18.6	26.9	30.6	35.4	35.3	35.2	36.5	37.3
标准偏差 (分贝) Std. Dev.(dB)		2.2	2.4	2.4	3.1	2.6	3.1	3.3	2.8	3.2
Viking™ V2		NRR 25			Over-the-Head					
频率 (赫兹) Frequency/Hz		125	250	500	1000	2000	3150	4000	6300	8000
平均衰减 (分贝) Mean Attn.(dB)		15.2	20.4	28.9	34.2	36.6	39.0	37.0	37.7	38.3
标准偏差 (分贝) Std. Dev.(dB)		2.2	2.1	2.3	2.6	2.7	2.8	2.8	2.6	3.1
Viking™ V2		NRR 24			Behind-the-Head					
平均衰减 (分贝) Mean Attn.(dB)		16.4	20.5	27.9	34.4	35.7	39.3	37.6	38.0	37.4
标准偏差 (分贝) Std. Dev.(dB)		2.5	2.3	2.6	2.9	2.8	3.2	2.9	3.0	3.1
Viking™ V2		NRR 24			Under-the-Chin					
平均衰减 (分贝) Mean Attn.(dB)		16.3	19.9	27.9	34.7	36.5	40.0	38.4	37.0	36.9
标准偏差 (分贝) Std. Dev.(dB)		2.7	2.8	2.7	2.7	2.9	3.4	2.9	3.3	3.3
Viking™ V3		NRR 29			Over-the-Head					
频率 (赫兹) Frequency/Hz		125	250	500	1000	2000	3150	4000	6300	8000
平均衰减 (分贝) Mean Attn.(dB)		22.9	24.8	31.4	35.9	39.6	41.6	41.5	39.2	37.0
标准偏差 (分贝) Std. Dev.(dB)		2.2	2.0	1.9	2.2	2.0	2.3	3.2	3.2	3.0
Viking™ V3		NRR 28			Behind-the-Head					
平均衰减 (分贝) Mean Attn.(dB)		21.0	24.2	31.4	36.3	39.4	41.1	41.6	39.1	36.5
标准偏差 (分贝) Std. Dev.(dB)		1.8	1.8	2.6	1.7	2.6	3.6	2.7	2.5	1.9
Viking™ V3		NRR 28			Under-the-Chin					
平均衰减 (分贝) Mean Attn.(dB)		20.9	24.5	30.6	34.9	37.5	40.2	40.8	39.1	35.5
标准偏差 (分贝) Std. Dev.(dB)		3.1	1.9	1.7	1.4	2.0	2.1	2.3	2.5	2.3

声音管理耳罩系列

Sound Management Earmuffs

有时候只是隔绝噪音并不能够完全满足需要，你希望在隔绝噪音的同时还能听到需要的信息。我们的声音管理耳罩用专利的被动或者电子技术不仅隔绝噪音，同时又可以让您听到警报和同事的说话声。

Sometimes blocking sound isn't enough. You need to block noise and let information in. Our Sound Management earmuffs use patented passive and electronic technologies that block noise out while alarms, warnings and even co-workers' voices can be heard more naturally.

Clarity 耳罩系列

Clarity Earmuffs

- 杜绝来自外界的高频及低频噪声，自然导入人声频率，以加强工作中的沟通效果
- 绝缘设计可用于电力环境
- 多节式可调节头带确保在使用时能很好的固定
- 单元式的耳罩垫更换快捷方便
- Uniform attenuation allows wearer to hear co-workers, instructions and other important sounds more naturally while blocking out harmful noise.
- Dielectric construction suitable for all workplaces, especially electrical environments
- Quick click height adjustment remains fixed during wear
- Snap-in ear cushions make replacement quick and easy

C3



头带型 Headband - C1,C2,C3

- 柔软舒适，内附海绵的头带，长久佩戴更加舒适
- 可伸缩调节高度同时又确保在使用时能很好的固定
- Padded foam headband delivers superb comfort with minimum pressure on the head
- Telescopic height adjustment remains fixed during use

订货号 Ref.		
10 111 46	C3	27 NRR
10 111 45	C2	23 NRR
10 111 42	C1	20 NRR

运用先进的声音管理系统确保噪声防护下有效沟通

Advanced Sound Management Technology enhances communication on-the-job

Clarity™ C1		NRR 20									
频率 (赫兹) Frequency/Hz		125	250	500	1000	2000	3150	4000	6300	8000	
平均衰减 (分贝) Mean Attn.(dB)		16.6	23.9	28.7	23.2	28.4	33.7	33.2	33.9	37.1	
标准偏差 (分贝) Std. Dev.(dB)		1.9	3.0	2.5	1.9	3.5	2.8	3.0	2.5	3.2	
Clarity™ C2		NRR 23									
		Over-the-Head									
频率 (赫兹) Frequency/Hz		125	250	500	1000	2000	3150	4000	6300	8000	
平均衰减 (分贝) Mean Attn.(dB)		18.2	25.1	29.0	29.7	29.4	30.7	30.6	30.7	31.9	
标准偏差 (分贝) Std. Dev.(dB)		2.7	3.0	2.6	2.1	2.0	2.5	2.2	2.7	2.2	
		Behind-the-Head									
平均衰减 (分贝) Mean Attn.(dB)		17.0	25.2	30.0	28.3	29.3	31.1	30.7	30.3	31.3	
标准偏差 (分贝) Std. Dev.(dB)		2.9	3.0	2.4	2.2	2.3	2.7	2.6	3.0	2.7	
		Under-the-Chin									
平均衰减 (分贝) Mean Attn.(dB)		18.6	25	30.1	28.8	28.6	31.0	30.8	30.4	31.3	
标准偏差 (分贝) Std. Dev.(dB)		2.4	2.6	2.9	2.1	2.7	2.5	3.2	2.4	2.0	
Clarity™ C3		NRR 27									
频率 (赫兹) Frequency/Hz		125	250	500	1000	2000	3150	4000	6300	8000	
平均衰减 (分贝) Mean Attn.(dB)		26.5	31.2	36.0	31.7	31.4	33.6	36.4	37.3	37.6	
标准偏差 (分贝) Std. Dev.(dB)		3.1	3.2	2.1	1.7	2.2	2.0	1.6	2.7*	2.6	

C1F



订货号 Ref.

*10 111 43 C1F 20 NRR

折叠型 Folding - C1F

- 折叠后便于储藏和携带
- Convenient folding design for easy storage

Clarity™ C1F

频率 (赫兹) Frequency/Hz	125	250	500	1000	2000	3150	4000	6300	8000
平均衰减 (分贝) Mean Attn.(dB)	19.5	23.3	27.8	24.2	27.6	32.0	32.9	31.5	30.1
标准偏差 (分贝) Std. Dev.(dB)	4.0	2.8	2.9	2.2	2.7	2.9	2.9	3.2	3.4

C3H



订货号 Ref.

10 112 43 C3H 25 NRR
10 112 42 C1H 20 NRR

配帽型 Cap-mounted - C1H,C3H

- 可与多种安全帽配备使用
- 不用时可耳罩翻起，扣与帽上
- For use with wide range of popular hard hats
- Earcups snap in place during use and swing back when not in use

Clarity™ C1H

NRR 20

频率 (赫兹) Frequency/Hz	125	250	500	1000	2000	3150	4000	6300	8000
平均衰减 (分贝) Mean Attn.(dB)	19.2	22.6	27.0	22.0	28.1	33.7	32.2	33.6	35.0
标准偏差 (分贝) Std. Dev.(dB)	2.9	2.8	2.5	1.7	2.2	3.2	3.0	2.5	2.3

Clarity™ C3H

NRR 25

频率 (赫兹) Frequency/Hz	125	250	500	1000	2000	3150	4000	6300	8000
平均衰减 (分贝) Mean Attn.(dB)	26.5	30.0	34.0	29.8	29.4	33.6	37.4	36.6	38.1
标准偏差 (分贝) Std. Dev.(dB)	2.7	3.0	2.9	1.9	2.1	2.7	2.9	2.7	2.2

Impact



订货号 Ref.

10 103 76 Impact 23 NRR
10 106 32 ImpactH配帽型 21 NRR

Impact™ 电子耳罩

Impact通过先进的声音放大技术增强使用者对周围环境的意识，Impact让使用者可以听到重要的沟通信息-其他同事的说话声，警报等-而且这些信息是在一个安全的声音范围内。定位扬声器提供更自然并可知方向的声音。同时，通过一个先进的反馈技术，在噪声大于82分贝时，Impact可转换成被动式耳罩模式。Impact非常适合听力障碍的使用者或者帮助防止工作中的孤立感。

- 立体环绕效果，提供频率范围 80 - 14,000 Hz 的优异的声音还原
- 建立在耳罩内部的扬声器可再现外界声音的方向和距离
- 长达700小时的电池寿命
- 4小时自动关闭内部电子设备，以保证产品的节电功能
- 预留的输入端口，可连接电子音频设备。
- 耳罩内部同时提供了最高噪声限度（82dB）以确保听力防护

Impact enhances user awareness of their environment through advanced sound amplification technology. Impact allows wearers to hear important communication – other co-workers, alarms and warning signals – at a safely amplified level. Positioned microphones provide more natural, directional hearing. Through an advanced response technology, Impact reverts to passive earmuff mode when noise reaches 82 dB or above. Impact is ideal for hearing-impaired workers and can help prevent isolation on the job.

- Amplifies ambient sound to safe 82 dB – response technology reverts to passive hearing protector if noise reaches 82dB
- Sound amplification increases communication and awareness – employees can hear alarms/warning signals. Co-workers' voices
- Directionally places stereo microphones amplify and enhance sound for more natural hearing
- Snap-in ear cushions make replacement quick and easy
- Automatic shut-off after 4 hours
- Including 2 AA batteries for 140 hours of use

Impact™

NRR 23

频率 (赫兹) Frequency/Hz	125	250	500	1000	2000	3150	4000	6300	8000
平均衰减 (分贝) Mean Attn.(dB)	13.6	19.3	29.4	30.1	32.4	37.3	40.8	43.9	45.6
标准偏差 (分贝) Std. Dev.(dB)	2.4	2.3	1.9	2.1	2.8	2.6	2.4	2.7	2.2

Impact™ H

NRR 21

频率 (赫兹) Frequency/Hz	125	250	500	1000	2000	3150	4000	6300	8000
平均衰减 (分贝) Mean Attn.(dB)	14.2	19.2	29.7	26.9	28.8	35.4	41.0	43.8	44.9
标准偏差 (分贝) Std. Dev.(dB)	3.5	2.9	2.1	3.1	2.3	2.5	2.3	2.4	2.3



防护帽	Hard Hat	17
防护眼镜	Spectacles	17
护目镜	Goggles	21
防护屏	Faceshield / Visors	23
洗眼器	Eyewash	25
眼镜清洁套装	Clean Kits	28

配戴眼部和面部保护装置，可以避免90%的眼脸部事故



由于其构造，眼睛是一个特别敏感的器官，所受的损伤经常无法医治



霍尼韦尔眼脸部防护产品结合先进、安全的眼脸部防护技术与理念，真正立足中国市场，为中国市场提供符合中国工人使用习惯和真正适合中国工人佩戴的安全防护产品，让工作更安全，更舒适，更高效

机械性危险

冲击，灰尘，固体颗粒，沙砾

后果：角膜损伤或穿孔，虹膜撕裂，晶状体浑浊

化学性危险

液滴和液体飞溅：溶剂，气雾剂，酸，碱，水泥，灰浆等等

后果：角膜灼伤或浑浊，病毒感染，急性结膜炎，溃疡

放射性危险

红外线，紫外线，激光，强光

后果：白内障，角结膜炎，视网膜损伤或灼伤，晶状体浑浊

电击危险

直接接触，短路引起的电弧

后果：视网膜灼伤，角膜损伤（固体颗粒），晶状体损伤

高温危险

高温液体，熔化物质，火焰

后果：眼部重伤，角膜浊点

镜架专用指示符号

EN166 - 详细说明	B-D	制造商
EN167 - 光学试验法	Z87	通过美国标准
EN168 - 非光学试验法	+	通过高速冲击试验
EN169 - 焊接用滤镜	GB14866-2006	通过中国标准
EN170 - 紫外线滤镜	166	标准号
EN171 - 红外线滤镜	xxx	应用领域
EN172 - 工业用防日光滤镜		3=液体(液滴或飞溅)
EN175 - 焊接装备		4=较大灰尘颗粒 (颗粒直径>5微米)
EN379 - 活性焊接滤镜		5=气体和较小灰尘颗粒
		8=短路引起的电弧
		9=熔化的金属和高温液体
	F	防机械性危险
	F(T)	极端温度下防冲击 (从-5°C到+55°C)
	H	该装置适用于头较小者
	2.5	与镜架相容的最高等级号

镜片专用指示符号

S	有色镜片
+	通过高速冲击试验
3	代码号：说明滤镜种类： 2和3=紫外线；4=红外线；5和6=日光
1.2	保护等级：指明镜片的颜色(眼镜和护目镜为1.2到7之间)
B-D	制造商
	视力等级(1=长期配戴,2和3=临时配戴)
F	防机械性危险(F=45米/秒的冲击)
F(T)	极端温度下防冲击(从-5°C到+55°C)
8	防因短路引起的电弧
9	不粘熔化的金属,防止高温液体渗透
K	表面不受微粒腐蚀
N	防雾镜片
R	加强反射红外线能力
0	(O)为原装镜片,(V)为更换镜片(可选)

防护帽 Hard Hat



订货号 Ref.:
 BC86010000 白色 white
 BC86020000 黄色 yellow
 BC86030000 橘黄色 orange
 BC86070000 蓝色 blue
 BC86150000 红色 red

Deluxe™ 轻质低危险防护帽

- 轻质
- 两侧通风孔，透气性良好
- HDPE 材质帽壳
- 多种颜色可选：红色、黄色、桔黄色、蓝色、白色
- Light weight
- Two sides breathable holes, good breathability
- More color option: red, yellow, orange, blue, white
- HDPE material
- Four point suspension

防护眼镜 Spectacles

S600A 流线型防护眼镜

首款适合亚洲人脸型的流线型防护眼镜，根据近万名使用者的实际需求设计



- 亚洲镜框设计，为亚洲工作人员提供真正安全防护
 - 更宽阔镜框，适合亚洲人更宽阔平坦的前额
 - 更高和宽的鼻垫设计
- 柔软鼻垫和镜腿，提供全天候舒适保护
- 时尚镜框设计
- 一片式镜片设计提供更佳视野
- 彩色镜腿容易识别
- 优质防雾涂层
- C强防刮擦涂层可选，有效提供镜片寿命，特别适合亚洲工作环境，用钢丝球刮镜片表面不会留下痕迹
- 符合中国GB及美国ANSI标准
- Asia Fit frame design provide real safety to Asia workers
 - wider frame match Asian wider and platter forehead
 - wider and shorter nose bridge
- Softer material nose bridge and temples make the workers like wearing it for a whole day
- Style frame design
- One piece style big lens provides better vision
- Colorful temples easily to be recognized
- Outstanding anti-fog coating offers great clear vision
- Super hard coating, special anti-scratch coating technology make the lens last longer than normal
- Especially good for hard Asia working environment
- Use a pencil or steel ball to scratch the lens, nothing will be left!!
- Pass the ANSI Z87+

订货号 Ref.	镜架及镜腿 Frame/Temple	镜片 Colour Lens	防刮擦 Abrasion Resistant	防雾 Anti-Fog	使用环境 Applications
110100	蓝色 Blue	透明 Clear Fog-Ban	是 yes	是 yes	室内环境 indoor use
110110	黑色 Black	透明 Clear Fog-Ban	是 yes	是 yes	室内环境 indoor use
110111	黑色 Black	灰色 TSR Grey Fog-Ban	是 yes	是 yes	室内、室外环境 outdoor use & indoor use
110200	蓝色 Blue	透明 Clear Fog-Ban	加强 extra	否 no	室内环境 indoor use
110210	黑色 Black	透明 Clear Fog-Ban	加强 extra	否 no	室内环境 indoor use

经典设计款型——值得信赖的经典防护眼镜设计，完全满足作业者的防护需求，让其在佩带时自信自如。



S200A 亚洲款防护眼镜

- 亚洲镜框设计，为亚洲工作人员提供真正安全防护
 - 更宽阔镜框，适合亚洲人更宽阔平坦的前额
- 柔软鼻垫和镜腿，提供全天候舒适保护
- 防滑握点设计
- 可调节式镜腿
- 一片式镜片设计提供更佳视野
- 彩色镜腿容易识别
- 优质防雾涂层
- C强防刮擦涂层，有效提供镜片寿命，特别适合亚洲工作环境，用钢丝球刮镜片表面不会留下痕迹
- 符合中国GB及美国ANSI标准
- Asia Fit frame design provide real safety to Asia workers
 - wider frame match Asian wider and platter forehead
 - wider and shorter nose bridge
- Softer material nose bridge and temples make the workers like wearing it for a whole day
- Anti slip holding points
- Adjustable temples
- One piece style big lens provides better vision.
- Colorful temples easily to be recognized
- Outstanding anti-fog coating offers great clear vision
- Super hard coating, special anti-scratch coating technology make the lens last longer than normal.
- Especially good for hard Asia working environment.
- Use a pencil or steel ball to scratch the lens, nothing will be left!!
- Pass the ANSI Z87+

订货号 Ref.	镜架及镜腿 Frame/Temple	镜片 Colour Lens	防刮擦 Abrasion Resistant	防雾 Anti-Fog	使用环境 Applications
100100	蓝色 Blue	透明 Clear Fog-Ban	是 yes	是 yes	室内环境 indoor use
100110	黑色 Black	透明 Clear Fog-Ban	是 yes	是 yes	室内环境 indoor use
100111	黑色 Black	灰色 TSR Grey Fog-Ban	是 yes	是 yes	室外环境 outdoor use
100200	蓝色 Blue	透明 Clear Fog-Ban	加强 extra	否 no	室内环境 indoor use
100210	黑色 Black	透明 Clear Fog-Ban	加强 extra	否 no	室内环境 indoor use
100211	黑色 Black	灰色 TSR Grey Fog-Ban	加强 extra	否 no	室外环境 outdoor use

VisiOTG-A 亚洲款访客眼镜

- 专为亚洲人脸型设计
- 可佩带在校正眼镜外
- 可作为参观眼镜
- 全透明设计
- 防冲击，防雾，防刮擦
- 符合中国GB及美国ANSI标准
- Design for the Asian Face
- Available in 2 versions: uncoated or with Hardcoat & Fog-Ban anti-fog coating lens
- Superb optics allow clear, distortion free vision
- Single polycarbonate lens with integral sideshields and contoured nose bridge
- Fits comfortably over prescription spectacles



订货号 Ref.	镜架及镜腿 Frame/Temple	镜片 Colour Lens	防刮擦 Abrasion Resistant	防雾 Anti-Fog	使用环境 Applications
100001	透明 Clear	透明 Clear Fog-Ban	是 yes	否 no	室内环境 indoor use
100002	透明 Clear	透明 Clear Fog-Ban	是 yes	是 yes	室内环境 indoor use

Op-Tema 可调节防护眼镜



- 可调节柔软鼻夹
- 可调节镜腿，及系绳
- 一体式中桥设计
- 全视野轻质镜片
- 整体重量轻：30克
- 防雾，防冲击，防刮擦
- 符合中国GB、美国ANSI及欧洲标准
- Lightweight full view lens
- Built-in moulded browbar
- Soft, adjustable nosepiece
- Adjustable temple length and lens angle
- Durable lenses with Hardcoat & Fog-Ban anti-fog coating

订货号 Ref.	镜架及镜腿 Frame/Temple	镜片 Colour Lens	防刮擦 Abrasion Resistant	防雾 Anti-Fog	使用环境 Applications
1004947	透明/黑色 Clear/Black	 透明 Clear Fog-Ban	是 yes	是 yes	室内环境 indoor use

Millennia Classic 简洁款防护眼镜



- 流行全球的现代设计款型先驱之作
- 平衡而轻便的镜架，重量：32克
- 一体式中桥设计，视野开阔（包括侧视野）
- 镜片视野清晰，无光学扭曲和棱镜度偏差
- 可调节系绳
- 符合中国GB、美国ANSI及欧洲标准
- A design preferred by wearers in field trials and research
- Balance and lightness of frame, resulting in a virtually weightless feel
- Straight temples, no adjustments or clumsy spatula-temples necessary
- Adjustable, breakaway Flexicord retainer for added security and convenience in the active work environment
- Comfortable, universal nose bridge
- Unique 9 base curved lens design for excellent optical qualities and complete protection
- Durable lenses with Hardcoat & Fog-Ban anti-fog coating
- A full, unobstructed field of vision, including side view

订货号 Ref.	镜架及镜腿 Frame/Temple	镜片 Colour Lens	防刮擦 Abrasion Resistant	防雾 Anti-Fog	使用环境 Applications
10 027 81	黑色 Black	 透明 Clear Fog-Ban	是 yes	是 yes	室内环境 indoor use
10 027 82	黑色 Black	 灰色 TSR Grey Fog-Ban	是 yes	是 yes	室外环境 outdoor use
10 052 12	黑色 Black	 黄色 HDL Yellow Fog-Ban	是 yes	是 yes	光线较弱环境 low light
10 027 83	蓝色 Blue	 透明 Clear Fog-Ban	是 yes	是 yes	室内环境 indoor use
10 064 05	黑色 Black	 IR3	是 yes	否 no	气焊使用 welding applications
10 064 06	黑色 Black	 IR5	是 yes	否 no	气焊使用 welding applications

现代设计款型——更舒适时尚设计，符合现代审美趋势，让作业者更加乐意佩带。

Millennia Sports 运动款防护眼镜

- 传承Millennia Classic的优异性能
- 一体式中桥设计，视野开阔（包括侧视野）
- 抗冲击的三维聚酰胺镜腿符合人体工程学原理，方便与安全帽配合使用
- 可调节系绳
- 防雾、防冲击、防刮擦
- 符合中国GB、美国ANSI及欧洲标准
- All the performance and comfort features of the Pulsafe Millennia Classic with a sleek frame giving it a true sport design
- Adjustable retainer: Flexicord
- Transparent "moulded-in-lens" brow for improved vision and comfort
- 3D ergonomically curved high impact nylon temples to accommodate hard-hat harnesses more comfortably



订货号 Ref.	镜架及镜腿 Frame/Temple	镜片 Colour Lens	防刮擦 Abrasion Resistant	防雾 Anti-Fog	使用环境 Applications
10 059 85	黑色 Black	 透明 Clear Fog-Ban	是 yes	是 yes	室内环境 indoor use
10 059 86	黑色 Black	 灰色 TSR Grey Fog-Ban	是 yes	是 yes	室外环境 outdoor use

VL1-A 亚洲款防护眼镜

- 专为亚洲人脸型设计
- 弧型时尚设计
- 防雾，防冲击，防刮擦
- 符合中国GB及美国ANSI标准
- Design for the Asian Face
- Lightweight full view lens
- A full, unobstructed field of vision, including side view
- Durable lenses with Hardcoat & Fog-Ban anti-fog coating



订货号 Ref.	镜架及镜腿 Frame/Temple	镜片 Colour Lens	防刮擦 Abrasion Resistant	防雾 Anti-Fog	使用环境 Applications
10 00 20	透明/黑色 Clear/Black	 透明 Clear Fog-Ban	是 yes	是 yes	室内环境 indoor use
10 00 21	透明/黑色 Clear/Black	 灰色 TSR Grey Fog-Ban	是 yes	是 yes	室外环境 outdoor use
10 00 22	透明/黑色 Clear/Black	 银灰色	是 yes	否 no	室内/外环境 indoor/outdoor use

护目镜 Goggles

DuraMaxx 全景式高效涂层护目镜

- 全景式现代款型设计确保完美面部贴合，提供最大程度的面部及视觉舒适效果
- DuraStream 涂层技术C 强防雾涂层和更有效的通风设计带来的高防雾性能
- DuraStream 涂层技术超强防刮擦涂层延长镜片使用寿命三倍
- 硅胶软材带来的脸部舒适感，更柔软接触，无压力，更完美贴合，更光滑感受
- 可轻松准确调整头带设计
- 可更换镜片，三秒钟更换时间，简单便捷

DuraMaxx 全景式高效涂层护目镜同时具有以下功能

真正的OTG护目镜，可与普通近视眼镜一起佩戴

符合欧标EN，美标ANSI，国际GB

订货号 Ref.	镜片 Frame	产品描述 Description	防刮擦 Abrasion Resistant	防雾 Anti-Fog
10 177 50	 透明PC镜片	蓝灰色镜身/布质头带/DuraStream涂层	加强	是
10 177 51	 透明PC镜片	蓝灰色镜身/橡胶头带/DuraStream涂层	加强	是
10 281 35	 透明PC镜片	DuraStream涂层替换镜片	加强	是
10 177 39	 IR5 PC镜片	蓝灰色镜身/橡胶头带/DuraStream涂层	加强	是
10 281 40	 IR5 PC镜片	DuraStream涂层替换镜片	加强	是

180度全景大视野



V-Maxx 运动型护目镜

- 180度全景大视野护目镜，不会产生视觉变形
- 可配合校正眼镜或呼吸半面罩使用
- 可选头带材料
- 角度可调节的弹性头带，方便与安全帽配合使用，在不同位置均能保持舒适
- 间接通风，防液体飞溅
- 符合中国GB、美国ANSI及欧洲标准
- 180° field of vision for distortion free peripheral vision
- Fits a wide variety of workers and can be worn over prescription eyewear and with half-mask respirators
- Rotating strap attachments for easier use with hard hats
- Special concept of indirect ventilation to comply with splash-resistance test
- Acetate lens with hardcoat & Fog-Ban

订货号 Ref.	镜架及镜腿 Frame/Temple	镜片 Colour Lens	防刮擦 Abrasion Resistant	防雾 Anti-Fog	使用环境 Applications
10 061 93	透明PC镜片,间接通风	透明 Clear Fog-Ban	是 yes	是 yes	室内环境 indoor use
10 075 06	透明聚醋酸酯镜片,间接通风,防化,氯丁橡胶头带	透明 Clear Fog-Ban	是 yes	是 yes	室内环境 indoor use
10 081 11	焊接镜片	IR5	是 yes	是 yes	气焊使用 welding applications

LG10 轻便型护目镜

Excellent value for money in a lightweight

- 聚碳酸酯镜片提供优异防冲击性能，同时也能防风及液体
- 重量轻，长久佩戴依然舒适
- 柔软镜框、简易头带。适合各类人群佩戴
- 符合中国GB、美国ANSI及欧洲标准
- Comfortable design
- Impact resistant polycarbonate lens for excellent protection against flying particles, coarse dusts, liquid droplets, mists and sprays
- Lightweight design for perfect comfort and wearer acceptance
- Extra soft seal and easily adjustable headband fits a wide variety of workers



订货号 Ref.	镜架及镜腿 Frame/Temple	镜片 Colour Lens	防刮擦 Abrasion Resistant	防雾 Anti-Fog	使用环境 Applications
10 055 04	透明PC镜片	透明 Clear Fog-Ban	是 yes	否 no	室内环境 indoor use

护目镜夹—GC2000
Goggle Clip

- 护目镜夹采用耐用的绝缘材料，适合于除全帽沿以外的所有安全帽。3个/包
- Design with durability material, 3 piece / bag



订货号 Ref.: GC2000

防护屏

Faceshield / Visors

10 023 30



10 023 25

10 023 12



Supervisor

适用于重工业领域中与安全帽配合使用

- 能配合多种款式的安全帽产品
- 面屏固定方便，更换简易
- 弯折预成型面屏，能有效起到最大脸部防护能力
- 根据不同工作环境提供多种面屏可供选择

A robust, heavy-duty, helmet mounted faceshield range with hearing protection compatibility

- Compatible with wide range of helmet designs (size, shape and geometry)
- Visor fixing method is secure and allows easy visor replacement
- Creased visor eliminates gaps and visor profile follows contours of the face for maximum protection, allowing full unrestricted head movement
- Visor selection can be tailored to the specific hazard/application: mechanical, chemical, heat etc

订货号 Ref.	产品描述 Description	镜片 Colour Lens	使用环境 Applications
10 023 02	面屏支架（用于安全帽）		
10 023 12	聚碳酸酯 PC防护面屏（需配合1002302支架使用）	 透明 Clear Fog-Ban	防机械冲击 heavy mechanail tasks
10 023 30	聚醋酸酯 绿色5#防护面屏（需配合1002302支架使用）	 IR5	气焊使用 welding applications
10 023 25	聚碳酸酯 PC镀金 吸收/抵御热融金属 防护面屏（需配合1002302支架使用）		吸收/抵御热融金属 molten metal/radiant heat

安全，实用，经济
Safe, practical, economical

Clearways

- Clearways头戴式面屏组合提供了优异的经济性及耐用性
- 总重量仅为160克，适合全天佩戴
- 提供聚碳酸酯和聚醋酸酯两种材料面屏可选择
- 聚醋酸酯面屏能有效防护化学物质飞溅
- The Clearways combination offers both strength and durability
- Only 160g, it is comfortable enough to wear all day
- Integral visor fitting ensures extra protection against chemical seepage
- Economical replaceable visors available in acetate or polycarbonate

订货号 Ref.	产品描述 Description	镜片 Colour Lens	使用环境 Applications
10 023 41	独立佩戴式面屏支架		
10 023 53	聚碳酸酯PC防护面屏（需配合1002341支架使用）	 透明 Clear Fog-Ban	防机械冲击 heavy mechanail tasks
10 023 60	聚醋酸酯防护面屏（需配合1002341支架使用）	 透明 Clear Fog-Ban	化学品飞溅 chemical projections

A8150/40



经济型面屏 Economic Faceshield

用于防护颗粒物,液体飞溅,热固体的喷溅和撞击,方便安装和使用.

Protection against foreign particles, chemical splash, heat, and impact resistance

经济型面屏支架 Economic Face shield Bracket

BD-173B



SE-173A

安全帽面屏支架 Headgear for Hardhat

- 圆形卡槽, 带有弹簧带
- 可以方便、牢固的安装在安全帽上
- 防护屏可以翻起, 可定位在任何角度
- 需与防护屏组合使用
- ABS construction, grooved frame with spring coil, easy to install on helmet.
- Positive stop hinge automatically holds visor in raised position.
- Use with visor



BD-176B

SE-173A

头带式防护屏支架

- 带有帽沿, 可以保护前额不受伤害
- 棘轮悬架和吸汗带可以调节, 增加舒适感
- 防护屏可以翻起, 并定位在任何需要的角度
- 需与防护屏组合使用
- Browguard eliminated forehead injury, adjustable ratchet suspension and sweatband for adding comfort, tension knobs allows flip-up visor to be positioned as user wishes

订货号 Ref.	产品描述 Description	镜片 Colour Lens	材料	其他
SE-173A	经济型面屏	 透明 Clear Fog-Ban	聚碳酸酯	带铅边
SE-174A	经济型面屏	 IR5	聚碳酸酯	带铅边
A8150/40	经济型面屏	 透明 Clear Fog-Ban	PET-G	不带铅边
BD-173B	安全帽面屏支架		塑料	配合SE-173A/SE-173B
CP5004	安全帽面屏支架		铝制	配合A8150/40
CP5007	安全帽面屏支架		塑料	配合A8150/40
BD-176B	头带式面屏支架		塑料	配合SE-173A/SE-173B

洗眼器 Eyewash



Porta Stream 系列便携式紧急洗眼器 Fendall Emergency Eyewash Station

- Porta Stream® II 便携式洗眼器能提供15分钟不间断的眼部标准冲洗
- Porta Stream® I 便携式洗眼器能提供6分钟不间断的眼部标准冲洗
- 可根据需求安装在墙面，并可随时移动
- 搭配移动推车使用，便可快速移动到事发现场
- 拉扣式喷淋头设计，方便快速及简便的喷淋
- Porta Stream® II内含180盎司（5.3升）浓缩洗眼液。
- Porta Stream® I 内含70盎司（2升）浓缩洗眼液
- 每6个月必须清洁水槽，可选附件清水防腐剂，可保证水槽内水质120天内有效
- Porta Stream® II offers versatile portability and 15-minutes of uninterrupted flushing - without costly plumbing. Porta Stream's simplicity of installation and operation has made it an industry favorite. It is easily removed to activate flushing, leaving hands free to hold eyelids open. Include Eyesaline Concentrate 180 oz. Container
- Porta Stream® I offers versatile portability and 6-minutes of uninterrupted flushing - without costly plumbing. Porta Stream's simplicity of installation and operation has made it an industry favorite. It is easily removed to activate flushing, leaving hands free to hold eyelids open. Include Eyesaline Concentrate 70 oz. Container
- Maintenance: 6 month change/ cleaning

	订货号 Ref.	产品描述 Description
Porta Stream 系列便携式紧急洗眼器	32-000200	Porta stream II(15分钟流量 16加仑 (60升)水槽)
	32-000100	Porta stream I (6分钟流量 8加仑 (30升) 水槽)

便携式紧急洗眼器附件:



订货号 Ref.: 32-001100

瓶装清水防腐剂 Eyesaline Preservative

- 适用于 Porta Stream 各款便携式洗眼器
- 抑制细菌增长长达 120 天。
- 每瓶 8盎司 (237毫升) 可使用于 16加仑(60升)水。
- 保质期 30个月 (未开封)
- Use with all portable devices.
- Inhibits bacteria growth up to 120 days.
- One bottle 8 oz.(237 ml.) will preserve 14-16 gallons.
- 30-month shelf life (unopened).
- Sold in cases of four with tamper evident seals

便携式紧急洗眼器附件:



订货号 Ref.: 32-001065-0000

洗眼器支架 Universal Eyewash Stand

洗眼器支架为就近安装便携式洗眼器在需要的工作场所提供了选择。它允许我们在工作环境改变时可以方便的移动便携式洗眼器。

- 墙式固定的另一种替代方案
- 能够被安装在地面或者自由站立
- 重量轻，坚实钢管结构25 lbs (11.3kg)
- 5分钟内即可安装完毕，包括所有安装附件
- 提供移动推车可选

The Universal Eyewash Stand presents a flexible option for installing portable eyewash units near workplace hazards. It allows a unit to be moved when hazardous locations change. The stand mounts securely to floor surfaces preventing displacements of a unit in high traffic environments.

- Inexpensive alternative to wall mounting.
- Can be mounted to floors or left free-standing.
- Lightweight, sturdy steel tubing design 25 lbs
- Assembles in less than 5 minutes, all assembly parts are included.
- Designed for use with Sperian units and most competitive portable devices.



订货号 Ref.: 32-001060

移动推车 Universal Cart

- 移动推车，可悬挂 Porta Stream® I 或 Porta Stream® II 洗眼器
- 移动推车，可悬挂 Fendall Porta Stream® I 或 Porta Stream® II 洗眼器
- Use with all portable devices.
- Provides quick, easy portability for self-contained, gravity-fed emergency eyewash devices.
- Reliable, hand-truck design ensures durability



订货号 Ref.: 32-001187

便携式紧急冲淋装置 Fendall Emergency Shower

- 紧急全身冲淋装置（附带拎包）
- 与SCBA组成紧急救援设备
- 2分钟内快速展开
- 携带方便（图示中下方集水槽需额外订购）
- Emergency Shower with Carry Bag
- Accommodates emergency responder in full chemical gear with SCBA
- Lightweight, compact design – assembled and operational in less than two minutes by one person



订货号 Ref.: 2210

墙式洗眼器

- 进水口 1/2" (1.27厘米), 出水口 1-1/4" (3.18厘米)
- 1-1/4" (3.18厘米) 电镀钢制立柱
- Water Inlet: 1/2"
- Water Outlet: 1-1/4"



订货号 Ref.: 2220

立式洗眼器

- 进水口 1/2" (1.27厘米), 出水口 1-1/4" (3.18厘米)
- 1-1/4" (3.18厘米) 电镀钢制立柱
- Water Inlet: 1/2"
- Water Outlet: 1-1/4"



订货号 Ref.: 4220

复合式洗眼喷淋装置

- 防腐蚀环氧树脂, 落地式, 复合式洗眼及喷淋装置
- Shower/eye wash stay open valves ABS shower head and bowl

眼镜清洁套装 Clean Kits



订货号 Ref.: 10 113 79

镜片擦拭纸 Lens Cleaning Tissues

- 500抽擦拭纸
- 特殊表面，对镜片无磨损
- 500 per box
- Non-abrasive to protect coatings



订货号 Ref.: 10 113 78

镜片清洁喷剂 Lens Cleaning Solution

- 500毫升容量
- 无酒精及硅成分，可保护镜片涂层
- 500ml spray bottle
- Contains no alcohol or silicone



订货号 Ref.: 10 113 80

镜片清洁套装 Lens Cleaning Station

- 方便携带设计，亦可固定安装
- 无酒精及硅成分可保护镜片涂层
- 包含：500ml清洁剂 - 1500抽擦拭纸
- Easily portable and disposable
- Contains no alcohol or silicone
- Contains: 500ml spray bottle of Pulsafe Clear lens cleaning solution - 1500 non-abrasive tissues

套进式眼镜绳 Spectacle Cords

- 套进式眼镜绳可与霍尼韦尔所有安全防护眼镜配合使用，直接套在镜腿上即可，方便快捷，直接拉出摘卸，防止眼镜绳卡在某处时工人无法脱身。
- Black spectacle safety cord
- It gives added security and convenience in the active work environment

订货号 Ref.: 10 057 71



口罩	Disposable Mask	31
半面罩	Reusable Half Mask	34
全面罩	Reusable Full Face Mask	37
过滤件	Cartridge and Canisters	40
动力送风及长管呼吸系统	PAPR and SAR	45
自给开路式压缩空气呼吸器	SCBA	55
逃生系统	Escape Devices	67
高压气瓶充气泵	Compressor	70

过滤设备使用等级 – 欧洲标准

气体/蒸气防护等级:

- 等级一** 气体体积浓度小于 0.1% (建议选择滤盒产品)
- 等级二** 气体体积浓度介于 0.1%-0.5% 之间 (建议选择滤罐产品)
- 等级三** 气体体积浓度介于 0.5%-1% 之间 (建议选择系于腰带上的大容量滤罐产品)

颗粒, 粉尘, 气溶胶防护等级:

- 等级一** 用于防护不具有特殊毒性的大颗粒 (例如: 碳酸钙颗粒)
- 等级二** 用于防护固体或者液体的气溶胶, 以及有危险性和腐蚀性的液体 (例如: 二氧化硅 – 碳酸钠)
- 等级三** 用于防护有毒的固体或者液体 (例如: 铍)

过滤设备选择表 – 欧洲标准

过滤罐的选择需遵循以下原则:

- 根据有毒物质种类选择防护
- 完成工作的方式和时间
- 从事工作的性质
- 使用的工具

色码

A	沸点高于65°C的有机气体及蒸气
AX	沸点低于65°C的有机气体及蒸气
B	无机气体及蒸气: 氯气, 硫化氢, 氰酸等
E	酸性气体及蒸气: 二氧化硫等
K	有机氨基衍生物—氨水
P	固态和液态的微粒, 气雾
HG	汞
NOP ₃	氮氧化物
CO	一氧化碳

Filter usage categories - European standard

Gas / Vapour protection:

- Class 1** for a gas content below 0.1% in volume (filters)
- Class 2** for a gas content between 0.1% and 0.5% in volume (cartridges)
- Class 3** for a gas content between 0.5% and 1% in volume (large-capacity canisters worn on the belt)

Protection from particulates, dust and aerosols:

- Class 1 (P1 or FFP1)** for protection against coarse solid particulates without specific toxicity (calcium carbonate)
- Class 2 (P2 or FFP2)** against solid and/or liquid aerosols and/or liquids indicated as dangerous or irritating (silicon dioxide – sodium carbonate)
- Class 3 (P3 or FFP3)** against toxic solid and/or liquids (beryllium – calcium carbonate – exotic woods)

Choosing a filter - European standard

A filtering cartridge is selected according to the following:

- The toxic substances from which protection is sought
- The work to be performed
- The mode of operation and length of action
- The devices at hand

Colour Code

A	Organic vapours, solvents and hydrocarbons
AX	Organic volatile gas vapours - Boiling point below 65°C
B	Inorganic gases and vapours, e.g. chlorine, hydrogen sulphide, hydrocyanic acid
E	Acid gases – sulphur anhydride
K	Organic amine compounds – Ammonia
P	Particulates, solid and liquid aerosols
HG	Mercury
NOP ₃	Nitrogen monoxide
CO	Carbon monoxide

	标准号 Standard	过滤效率分类 Filtering category	过滤效率 Filtering rate	防护种类 Protection	测试流量 Test flow rate
美标 USA	NIOSH 42CFR84 (1995年版) (1995 version)	N95/R95/P95	95%	• N-非油性颗粒 N:no oil aerosols • R-非油性油性颗粒兼防(时间限制) R:oil aerosol(limited duration) • P-非油性油性颗粒兼防 P:oil aerosol (long duration)	85L / 分钟 85L / Min
		N99/R99/P99	99%		
		N100/R100/P100	99.97%		
欧标 Europe	EN149-2001 (2001年版) (2001 version)	FFP1	>=80%	非油性油性颗粒兼防 both kinds of aerosols (Oil or Non oil)	95L / 分钟 95L / Min
		FFP2	>=94%		
		FFP3	>=99%		
国标 GB	GB2626-2006	KN90/KP90	>90%	• KN-非油性颗粒 KN:no oil aerosols • KP-油性颗粒 KP:oil aerosol	85L / 分钟 85L / Min
		KN95/KP95	>95%		
		KN100/KP100	>99.97%		

- 鼻型外壳设计，与面部曲线完美结合，方便佩戴眼镜。
- 无鼻夹，免除鼻夹压力，省去调节烦恼
- 六点焊接技术，使内衬与外壳紧密结合，防止内衬在呼吸时触及鼻部和嘴
- 棉质头带，吸汗不紧绷
- 坚硬外壳，有效抵挡冲压
- 柔软内衬，减少对皮肤的刺激
- 优质滤材，保证大大低于标准要求的吸气与呼气阻力
- Pre-formed upper nose shape, excellent fit and perfectly compatible with eyewear
- Non-nose bridge design minimizes pressure points.
- Inner layer welded at six points to outer shell front to eliminate being drawn into mouth and nose during inhalation
- Elastics for comfort and convenience. No uncomfortable staples.
- Soft inner layer for comfort. Fort with minimal pressure on the head

SuperOne N95舒适型口罩

符合美国 NIOSH N95 标准 NIOSH N95 standard



- 全新革命性设计，与面部曲线完美贴合
- 省却调节鼻夹的烦恼，带给你前所未有的呼吸感受
- 高性能呼吸效率，符合符合NIOSH标准
- A revolutionary design fits face perfectly
- Cancel the nose bridge bringing an unsurpassed feeling and extreme comfort for the higher work safety and pleasure
- NIOSH

美标NIOSH口罩

- C柔软鼻夹设计，金属部分不外露，防止金属摩擦
- 低呼吸阻力，大大提高佩带舒适度
- 海绵鼻部内衬，有效提高脸部贴合度及佩带舒适度
- 不含PVC，硅，以及乳胶
- 适用于纺织，煤矿，石化，汽车制造等几乎所有工业

NIOSH Disposable Mask

- soft nose bridge, no metal outside, avoiding friction
- Lower breathing resistant to provide super comfort
- Ultra soft triple sponge seal perfectly to fit the face
- Environment-friendly without PVC and silicone
- Application: Textile, mining, construction, iron and steel, woodworking, car industry, food industry, cutting and moldings ect.

符合美国 NIOSH N95 标准 NIOSH N95 standard



订货号 Ref.: BC10 055 84

801 N95标准型口罩

- 权威医学机构实验证明有效防护禽流感，SARS等病毒
- According to the authoritative studies, it is approved to provide protection against virus of SARS Avian flu, etc.

5130 N95标准型口罩

- 美标N95防护级别，防护非油性颗粒。含柔软鼻夹及海绵内衬，舒适贴合面部。为霍尼韦尔重拳推出的标准款型号
- N95 mask, Non-Oil, Particulate Respirator, open cell foam nose cushion, nose clip
- * NIOSH N95 standard; protective against non-oil particulates. Soft nose clip and foam cushion perfectly to fit the face; 5130N95 is one of the standard and core models.

订货号 Ref.:5130N95

订货号 Ref	产品说明 Description	尺码 Size	密封衬垫 Seal	呼气阀 Exhale valve	包装 Package
1015790	SuperOne 舒适型 /Comfort	均码 /all	无鼻夹 /No nose bridge	不含 /no	20 只 / 盒 20 EA/BOX
1015791	SuperOne 舒适型 /Comfort	均码 /all	无鼻夹 /No nose bridge	含 /yes	10 只 / 盒 10 EA/BOX
BC1005584	801 标准型 /Standard	均码 /all	海绵条形 /foam	不含 /no	30 只 / 盒 30 EA/BOX
5130N95	5130 标准型 /Standard	均码 /all	海绵条形 /foam	不含 /no	30 只 / 盒 30 EA/BOX



订货号 Ref.:7130N95

7130 N95舒适型口罩

- 美标N95防护级别，防护非油性颗粒。含柔软鼻夹及舒适护鼻密封内衬，有效提高面部密合，同时保证佩戴舒适感
- 7130 N95 mask, Non-Oil, Particulate Respirator, closed cell foam nose cushion
- NIOSH N95 standard; protective against non-oil particulates. Soft nose clip and comfortable nose cushion perfectly to fit the face and ensure great wearing comfort.



订货号 Ref.:7140N95

7140 N95舒适型带阀口罩

- 美标N95防护级别，防护非油性颗粒。在7130N95的设计基础上，增加了内置呼气阀配置，有效降低呼吸阻力。适合湿热环境或长时间佩戴需求
- 7140 N95 mask, Non Oil, Particulate Respirator with Exhalation Valve, closed cell foam nose cushion
- NIOSH N95 standard; protective against non-oil particulates. With all the features of 7130N95, 7140N95 has a specially designed breathing valve which can effectively reduce breathing resistance to suit the humid and hot environment



订货号 Ref.:8145P95

8145 P95全密封型活性炭口罩

- 美标P95防护级别，油性和非油性颗粒兼防。含柔软鼻夹，可调节式头带，口罩内部为360度全密封贴面设计，具有卓越的面部密合性能
- 同时配有内置呼气阀，有效降低呼吸阻力。适合湿热环境或长时间佩戴需求
- 滤材料含活性炭成分，在允许暴露浓度（安全浓度）以下的环境，可同时用于颗粒物防护及去除难闻的有机气体、酸性气体及臭氧的气味（如二氧化硫、氟化氢、氯气等）
- 8145 P95 mask, Particulate & Oil Respirator with Exhalation Valve, with carbon

订货号 Ref	产品说明 Description	尺码 Size	密封衬垫 Seal	呼气阀 Exhale valve	包装 Package
7130N95	N95 舒适型	大号 / 中号 M/L	舒适护鼻密封型 Comfort seal	不含 /no	20 只 / 盒 20 EA/BOX
7130N95S	N95 舒适型	小号 S	舒适护鼻密封型 Comfort seal	不含 /no	20 只 / 盒 20 EA/BOX
7140N95	N95 舒适型	大号 / 中号 M/L	舒适护鼻密封型 Comfort seal	配有 /yes	10 只 / 盒 10 EA/BOX
7140N95S	N95 舒适型	小号 S	舒适护鼻密封型 Comfort seal	配有 /yes	10 只 / 盒 10 EA/BOX
8145P95	P95 全密封型	均码 All	360 度全密封型 360 seal	配有 /yes	5 只 / 盒 5 EA/BOX

欧标FFP1及FFP2油性非油性颗粒物兼防口罩 EN FFP1 and FFP2 against oil and non-oil particulates disposable mask



订货号 Ref.: 10 055 91

5140 FFP1 舒适型活性炭口罩

- 在职业允许暴露浓度值以下，有效降低有机气体气味
- In case of exposure to levels of organic gases and vapours below OEL*(methyl-ethyl-cetone, glutaraldehyde, etc ...), offers reduction of the nuisance due to odours



订货号 Ref.: 10 055 84

5210 FFP2 舒适型口罩

- 有效防护禽流感，SARS等病毒
- According to the authoritative studies, it is approved to provide protection against virus of SARS Avian flu, etc.



订货号 Ref.: 10 055 86

5211 FFP2 舒适型带阀口罩

- 全新的呼气阀门设计，最大程度降低呼气阻力，迅速排除湿气
- With an innovative design to the new exhalation valve which provide the minimal exhalation resistance and a faster evacuation of the moist exhaled air

订货号 Ref	产品说明 Description	尺码 Size	密封衬垫 Seal	呼气阀 Exhale valve	包装 Package
1005591	5140 OV 舒适型 /Comfort FFP1	大号 / 中号 M/L	舒适型 /Comfort	不含 /no	20 只 / 盒 20 EA/BOX
1005584	5210 舒适型 /Comfort FFP2	大号 / 中号 M/L	舒适型 /Comfort	不含 /no	20 只 / 盒 20 EA/BOX
1005586	5211 舒适型 /Comfort FFP2	大号 / 中号 M/L	舒适型 /Comfort	配有 /yes	20 只 / 盒 20 EA/BOX

半面罩 Reusable Half Mask

CFR-1 4200 系列

- 含标准款及焊接专用款两种款型。口罩支架可以反复使用，仅需根据工作要求定期更换滤棉，降低整体使用成本。焊接专用款配有不锈钢网罩，有效防护高温火花或熔渣
- 口罩支架由TPE热塑弹性体材料制成，柔软舒适，卓越的抗油及抗化学品性能，使用寿命耐久
- 头部固定式，避免口罩移位。头带调整可经一次动作完成，佩戴快捷。无需佩戴时可自由悬挂于胸前
- 内侧为360度全密封贴面设计，具有卓越的面部密封性能焊接专用款同时配有吸气阀和呼气阀，有效降低了呼吸阻力
- 有两种尺寸可供选择，更好地贴合使用者面部，保证密封性能
- 使用过程中，使用者面部无需直接接触滤棉，保持滤棉干燥，提高佩戴舒适度
- Two versions for standard uses and welding use. Its rigid frame is reusable and the users only have to replace filters based on working demands which can reduce overall using cost. Welding version has a stainless steel mesh front which can effectively withstand high temperature sparkles and melting scraps.
- The face seal is made of TPE and features great softness and comfort. Excellent resistance to oil and chemicals ensures its long serving life.
- Fixing on the head can avoid any unnecessary movements of the nose cup. The adjustment of the head harness can be finished within seconds to make the donning very fast. It can be kept on your neck when you do not want to wear it.
- A 360° facial sealed inner face ensures great air tightness with user's face.
- The welding version is equipped with an inhalation and an exhalation valve to effectively reduce the breathing resistance.
- Two sizes for selection to better fit user's face and improve facial seal.
- The user has no direct contact with the filter during wearing which can keep the filter dry to make the wearing more comfortable.

CFR-1 4200 系列口罩更换滤棉步骤:

CFR-1 4200 series: steps to replace the filter

1. 打开位于口罩支架两侧的搭扣，打开支架封盖
 2. 取出并丢弃已使用过的滤棉后，将新的滤棉安装在支架底座上
 3. 关闭封盖，扣上搭扣，完成更换；不使用时，可使用颈带将其轻松悬挂与胸前，不影响双手操作
1. Open the buckles on both sides of the frame and the cover
 2. Take out and dispose the used filter and put the new filter onto the base of the frame
 3. Close the cover and buckles to finish the replacement
- When it is not necessary to wear the mask, you can use the neck harness to keep it in front of your chest and this won't affect any hands operation.

7190 N99 系列

- 霍尼韦尔为焊接作业者专门推出的一款创新设计
- 吸气阀/呼气阀两阀合一设计，提高呼吸效率，提高使用者的舒适度
- 特大防护表面设计，使用时间更长，无需频繁更换，降低整体使用成本
- 外形扁平，能够良好地与焊接头盔或者焊接面罩相适配
- 头带可调节，佩戴定位准确，不影响舒适度
- 配有可更换式的N99滤棉，有效防护焊接烟雾或其他非油性的颗粒
- Design for welding
- Inhale/exhale valve together, improve the efficient and feel comfortable
- Large surface of filter, and long duration
- Flat design to compatible with welding helmet
- Adjustable strap, fit well and fell comfortable
- N99 filter replacement



订货号 Ref.:4200M



订货号 Ref.:4200MW



订货号 Ref.:42N95/42R95



订货号 Ref.:7190N99 (配有N99滤棉)



订货号 Ref.:719009N99

类别 Type	订货号 Ref	产品说明 Description	尺码 Size	密封衬垫 Seal	气阀 Valve	包装 Package
口罩支架 Mask	4200M	N95 标准款 N95 Standard	大号 / 中号 M/L	360度全密封型 360 Round	配有 /yes	1套 (支架及滤棉各 1 个) 1EA
	4200S	N95 标准款 N95 Standard	小号 S	360度全密封型 360 Round	配有 /yes	1套 (支架及滤棉各 1 个) 1EA
	4200MW	N95 焊接专用款 N95 for welding	大号 / 中号 M/L	360度全密封型 360 Round	配有 /yes	1套 (支架及滤棉各 1 个) 1EA
	4200SW	N95 焊接专用款 N95 for welding	小号 S	360度全密封型 360 Round	配有 /yes	1套 (支架及滤棉各 1 个) 1EA
	7190N99	N99 焊接专用款 N99 for welding	均码 All	360度全密封型 360 Round	配有 /yes	1套 (支架及滤棉各 1 个) 1EA
滤棉 Filter	42N95	N95 滤棉, CFR -1 专用 N95 for CFR-1	均码 All	/	/	20只 / 盒 20 EA/Box
	42R95	R95 滤棉, CFR -1 专用 R95 for CFR-1	均码 All	/	/	10只 / 盒 10 EA/Box
	719009N99	N99 滤棉, 7190N99 专用 N99 for 7190N99	均码 All	/	/	2只 / 包 2 EA/Box



订货号 Ref.:770030



订货号 Ref.:550030

7700 / 5500 系列 半面罩系列

7700 / 5500 series half mask

- 可与电动送风(PAPR)或供气式(SA)呼吸防护产品配套使用, 满足不同防护环境的需求
- 特有口鼻罩最小空气“死腔”设计, 避免呼出的二氧化碳被再次吸入, 降低使用者的工作疲劳度
- 独有的呼气阀设计, 保证呼出气体最大程度被排出面罩之外, 提高使用者的佩戴舒适感
- 特有的面部曲线贴合设计, 360度密封, 可满足不同脸型佩戴需求。并且按人体工程学设计理念, 不同部位密封圈厚度不一, 更好地满足鼻部、下颌部及脸部对于贴合性的不同要求
- 头部固定式设计及可调节式头带保证佩戴定位准确, 不受作业者活动影响, 消除佩戴不适感
- 整体下探式外形, 避免对视线的影响, 与防护眼镜也能够良好适配

7700 系列为100% 硅胶设计。它 市场超过 20年, 是目前市场上将舒适、贴合、安全性结合的一款产品。

5500系列为一款经济款半面罩。它保留了7700系列的绝大部分性能, 由TPE热塑弹性体橡胶制成, 舒适经济。在防护性能不受影响的前提下, 最大程度地为客户节约使用成本。

- Can also be used with PAPR or supplied air respirators to fit different using environments.
- With specially designed oral/nasal cup to lessen"dead space", avoid re-breathing in of exhaled CO₂ and reduce the working fatigue of wearers.
- Specially designed exhalation valve can vent the gases out from the mask to the most so that the user can experience more wearing comfort
- Unique airtight curve of the inner mask offers 360°facial seal to fit various face shapes. It also has different mask thickness on different position based on the ideas of ergonomics design to ensure great fitness on the nose, chin and face.
- The head harness is positioned on the headband and also adjustable which can make the donning easy and comfortable regardless of any movements of the user.
- The shape is downwards designed in order to avoid any effects on the vision and also has a good compatibility with safety eyewear.

7700 series is made of 100% silicone and is one the most outstanding product in the market for over 20 years which features comfort, fitness and safety together.

5500 is the economic half mask. It keeps most of the features of 7700 and is made of TPE material which reduces the using costs of users to the most without sacrificing any protection ability.

* 选配的滤盒产品请参考第40~41页 N系列

* For cartridge selection please refer to P40 to 41 N series.

类别 Type	订货号 Ref	标准 Standard	产品说明 Description	尺码 Size	包装 Package
硅胶材料 Silicon	770030L	NIOSH	舒适款 Comfort	大号 L	1 只 / 盒 1EA /Box
	770030M	NIOSH	舒适款 Comfort	中号 M	1 只 / 盒 1EA /Box
	770030S	NIOSH	舒适款 Comfort	小号 S	1 只 / 盒 1EA /Box
TPE 材料 TPE	550030L	NIOSH	经济款 Economy	大号 L	1 只 / 盒 1EA /Box
	550030M	NIOSH	经济款 Economy	中号 M	1 只 / 盒 1EA /Box
	550030S	NIOSH	经济款 Economy	小号 S	1 只 / 盒 1EA /Box

符合美国 NIOSH 标准
NIOSH standard



订货号 Ref.:

31 150 0 小号

Small basic assembly with elastic headstraps

31 250 0 中号

Medium basic assembly with elastic headstraps

31 350 0 大号

Large basic assembly with elastic headstraps

* 选配的滤盒产品请参考第42页S系列

* For cartridge selection please refer to P42 S series.

Premier 系列硅胶半面罩

Premier Series Silicone Half Mask

- C低呼吸阻力 M舒适 S
- Premier 是同类产品中 方便使用的产品之一，独特的排汗孔设计减少面罩滑动和彻底消除可能由此引起的皮肤过敏。此高质量硅胶半面罩独有的密封边缘设计给您带来前所未有的舒适享受
- 弹性头带设计易调节
- 无阻碍视野
- 低轮廓设计不妨碍视野
- 业界呼吸阻力最低的产品之一
- 三种尺寸供选择
- 本产品为寻求低呼吸阻力和舒适度呼吸防护设备的专业用户，提供广泛的解决方案
- Low breathing resistance for maximum comfort.
- One of the easiest breathing respirators of its type, the Survivair Premier® incorporates a perspiration port to reduce facepiece slippage and skin irritation. This high quality, silicone respirator includes a soft sealing flange with rolled edges for increased wearer comfort.
- Elastic headstraps adjust at the crown for easy fit and unobstructed vision
- Low profile nosepiece allows for compatibility with eyewear
- Lower breathing resistance than most other available models
- Available in three sizes Recommended Use
- Ideal for professional users seeking comfort. Low breathing resistance for maximum comfort

符合美国 NIOSH 标准
NIOSH standard



订货号 Ref.:

B25 000 0 小号 Small basic assembly

B26 000 0 中号 Medium basic assembly

B27 000 0 大号 Large basic assembly

* 选配的滤盒产品请参考第42页S系列

* For cartridge selection please refer to P42 S series.

2000 系列硅胶半面罩

2000 Series Silicone Half Mask

- 重量轻，易维护
- 佩戴极其舒适的硅胶材料面罩，经久耐用，可以长时间使用和清洗
- 2000系列半面罩产品是业界最轻的半面罩产品之一，采用创新的设计可以自我调节鼻梁和佩戴角度，完全满足安全需求和佩戴眼部防护产品的需要
- 经久耐用，重量轻，硅胶材料面罩
- 顺滑的密封区设计确保适合各种脸型
- 全新的头带设计减少面罩松动
- 有三种尺寸供选择
- 本产品为寻求重量轻的呼吸防护设备的专业用户，提供广泛的防护
- Lightweight and easy to maintain
- With its comfortable silicone facepiece, this durable, user-friendly half mask air purifying respirator can withstand years of washing and use. One of the industry's lightest respirators, the 2000 Series features an innovative yoke design, and an angled, self-adjusting nose bridge to accommodate safety or prescription eyewear
- Durable, lightweight silicone facepiece construction
- Large, pliable sealing area for secure fit for almost any facial type
- Improved yoke and head harness design reduce facepiece slippage
- Available in three sizes Recommended Use
- Professional users who seek a lightweight respirator that will provide protection in a wide variety of applications

双滤盒半面罩

Double Filters Half Mask

- 采用硅胶外壳，非常轻便，经久耐用，与面部良好贴合
- 呼气阀用聚砜酮制成
- 配有可快速松开的调节带
- 可同时配戴眼镜



订货号 Ref.: B290

* 选配的滤盒产品请参考第42页B290系列

* For cartridge selection please refer to P42 B290 series.

- Made from EPDM, light weight
- Of good comfort, durable and tight seal
- Adjustable belt
- Can be worn over prescription spectacles at the same time

符合美国 NIOSH 标准
NIOSH standard

7600 / 5400 系列 全面罩系列 7600 / 5400 series full mask



订货号 Ref.:760008A



订货号 Ref.:54001

- 可与电动送风(PAPR)或供气式(SA)呼吸防护产品配套使用，满足不同防护环境的需求
- 特有口鼻罩最小空气“死腔”设计，避免呼出的二氧化碳被再次吸入，降低使用者的工作疲劳度
- 7600 含金属传音膜设计，可放大作业者音量，保证沟通效果
- 双重面部密封设计，加强面部贴合，保证密封效果，并可满足不同脸型佩戴需求
- 头部中央固定式设计加强面罩定位效果，在作业者剧烈运动情形下，也能保证完美的贴合密封效果
- 200度全视野设计，确保使用者在登高或下移过程中视线范围也不会受到影响
- 聚碳酸酯制面屏，符合ANSI高冲击强度需求。使用者无需另外佩戴防护眼镜

7600 系列为100% 硅胶设计。与7700半面罩产品相比，它具有更为卓越的舒适、贴合及安全性能。如您想选用防护系数比7700 更高的产品，7600 系列全面罩是您 好的选择。54001系列为一款经济款全面罩。符合NIOSH 标准。它保留了7600 系列的绝大部分性能，由TPE 热塑弹性体橡胶制成，舒适经济。在防护性能不受影响的前提下，最大程度地为客户节约使用成本。

- Can also be used with PAPR or supplied air respirators to fit different using environments.
- With specially designed oral/nasal cup to lessen "dead space", avoid re-breathing in of exhaled CO₂ and reduce the working fatigue of wearers.
- 7600 also offers a speaking diaphragm to amplify voices and make communication easy.
- Dual facial seal design to offer better seal on the face and satisfy various demands of different facial types.
- Center-fixing harness on the head enhances the stability which can provide perfect seal even during vigorous exercises.
- Provides a 200° field of vision to avoid any visual obstacles during climbing or descending.
- Polycarbonate lens meets ANSI standard for high impact so the users do not have to wear extra glasses.

7600 series is made of 100% silicone which offers better comfort, fitness and safety compared with 7700 half mask. If you need a respirator offering higher protection level than 7700 then 7600 full mask is your optimum choice.

54001 is the economic full mask of North offering which conforms to NIOSH standard. It keeps most of the features of 7600 and is made of TPE material which reduces the using costs of users to the most without sacrificing any protection ability.

- * 选配的滤盒产品请参考第40~41页 N系列
- * For cartridge selection please refer to P40 to 41 N series.

类别 Type	订货号 Ref	标准 Standard	产品说明 Description	尺码 Size	包装 Package	头带 Headstrap	滤盒 Connection
硅胶材料 Silicon	760008A	NIOSH	舒适款 Premium	大 / 中号 L/M	1 只 / 盒 1 unit/box	五点式 five points	双滤盒 twin cartridge
	760008AS	NIOSH	舒适款 Premium	小号 S	1 只 / 盒 1 unit/box	五点式 five points	双滤盒 twin cartridge
TPE 材料	54001	NIOSH	经济款 Economical	大 / 中号 L/M	1 只 / 盒 1 unit/box	四点式 four points	双滤盒 twin cartridge
TPE	54001S	NIOSH	经济款 Economical	小号 S	1 只 / 盒 1 unit/box	四点式 four points	双滤盒 twin cartridge

符合美国 NIOSH 标准
NIOSH standard



订货号 Ref.:

75 200 0 小号 Small Opti-Fit APR

76 200 0 中号 Medium Opti-Fit APR

77 200 0 大号 Large Opti-Fit APR

* 选配的滤盒产品请参考第42页S系列

* For cartridge selection please refer to P42 S series.

Opti-Fit™ 硅胶全面罩 Opti-Fit™ Silicone Full Face Mask

- 拥有完美的贴合度,舒适度和光学效果的硅胶全面罩产品。
- Opti-Fit™ 系列产品提供完美的表现和适应能力。它所具很多价格更高的产品才能具备的功能,帮助你合理的分担产品的预算。Opti-Fit™ 的面屏消除由面屏曲面造成的影像失真,提供真实的视觉效果。
- 重量轻设计,减轻由工作带来的头部和颈部的疲劳度。三种尺寸供选择几乎可满足所有类型脸型。
- 舒适,耐久性的硅胶裙边设计,五点头带
- 标准口鼻罩防雾设计
- 可更换面屏加以高强度防刮涂层。
- 可选购其它配件例如面屏贴膜,防雾布等
- Optimum fit, comfort and superior optics in a full face respirator.
- The Opti-Fit™ offers the ultimate in performance and affordability. With features usually reserved for more expensive respirators, the Opti-Fit™ can help you get the most from your respiratory protection budget. Opti-Fit™ features a distortion-free lens with exceptional view. Lightweight construction reduces head and neck stress even during extended wear. Three sizes fit almost any facial type.
- Comfortable, durable silicone skirt and five-strap suspension
- Nose cup is a standard feature to prevent fogging
- Lens is replaceable and treated with an anti-scratch coating
- Available accessories include clear and tinted lens covers, anti-fog wipes



订货号 Ref.: 17 106 41

* 选配的滤盒产品请参考第42页B290系列

* For cartridge selection please refer to P42 B290 series.

黄色全面罩 Cosmo Yellow

- EPDM 材料
- 全景式视野
- 与面部良好贴合
- Made of EPDM
- Panoramic field of vision
- Good seal



订货号 Ref.: 17 106 43

蓝色全面罩 Cosmo Blue

- EPDM 材料
- 全景式视野
- 专用传音膜
- 与面部良好贴合
- 可与RD40接口的所有过滤罐配合使用
- Made of EPDM
- Panoramic field of vision
- Speech diaphragm
- Good seal
- Compatible with all Willson and Fernez RD40 filters

符合欧洲EN标准
EN standard

订货号 Ref.: 17 150 01 小号 Small
17 150 11 中号 Medium
17 150 21 大号 Large

Opti-Fit™ 硅胶全面罩
Opti-Fit™ Silicone Full Face Mask

- 特殊处理聚碳酸酯面屏：耐腐蚀，防冲击，高透光率硅胶面罩体C常的舒适度，不会产生由氧化造成的粉末，维护方便
- 立体视野：完美无障碍的视觉体验
- 五点式头带，快速调节
- 硅胶群边与面部完美贴合，无与伦比的舒适感受
- RD40 接口
- Polycarbonate visor: abrasion resistant, impact resistant, high optical quality
- Inner mask, Silicone: comfortable, prevents misting of visor, easy maintenance valves
- High quality visor: for perfect vision, from head to toe
- 5-point head-harness, ThermoPlastic Elastomer: quick adjustment, high-resistance thermoplastic, mask can be positioned optimally
- Adjustment buckles: removal, resilient
- Silicone face-seal: exceptional comfort, watertight seal
- RD40 connection (EN 148-1)

5400 全面罩系列
5400 series full mask

订货号 Ref.:54301

- 可与电动送风(PAPR)或供气式(SA)呼吸防护产品配套使用，满足不同防护环境的需求
- 特有口鼻罩最小空气“死腔”设计，避免呼出的二氧化碳被再次吸入，降低使用者的工作疲劳度
- 双重面部密封设计，加强面部贴合，保证密封效果，并可满足不同脸型的佩戴需求
- 头部中央固定式设计加强面罩定位效果，在作业者剧烈运动情形下，也能保证完美的贴合密封效果
- 200度全视野设计，确保使用者在登高或下移过程中视线范围也不会受到影响
- 聚碳酸酯制面屏，符合ANSI高冲击强度需求。使用者无需另外佩戴防护眼镜

54301为硅胶设计，符合EN136标准。单滤罐配置，接头DIN直径为40mm，符合EN148-1标准。

54201为一款经济型全面罩产品。符合EN136标准。由EPDM三元乙丙橡胶制成，重量非常轻，并且具有良好的耐高温性能。



订货号 Ref.:54201

- Can also be used with PAPR or supplied air respirators to fit different using environments.
- With specially designed oral/nasal cup to lessen “dead space”, avoid re-breathing in of exhaled CO₂ and reduce the working fatigue of wearers.
- Dual facial seal design to offer better seal on the face and satisfy various demands of different facial types.
- Center-fixing harness on the head enhances the stability which can provide perfect seal even during vigorous exercises.
- Provides a 200° field of vision to avoid any visual obstacles during climbing or descending.
- Polycarbonate lens meets ANSI standard for high impact so the users do not have to wear extra glasses.

54301 is made of 100% silicone which offers better comfort, fitness and safety. 54301 conforms to EN136 with a connection DIN 40mm according to EN148-1.

54201 is the economic full mask which conforms to EN136 standard. It is made of EPDM material which reduces the using costs of users to the most without sacrificing any protection ability.

类别 Type	订货号 Ref	标准 Standard	产品说明 Description	尺码 Size	包装 Package	头带 Headstrap	滤盒 Connection
硅胶材料 Silicon	54301	EN136	舒适款 Premium	大 / 中号 L/M	1 只 / 盒 1 unit/box	五点式 five points	单滤罐 single canister
EPDM	54201	EN136	经济款 Economical	大 / 中号 L/M	1 只 / 盒 1 unit/box	四点式 four points	单滤罐 single canister

N 系列防毒滤盒 (NIOSH标准)

N series cartridge for gases/vapors protection (NIOSH standard)



订货号 Ref	描述 Description	包装规格 Package
N75001	防护有机气体及蒸气 Organic Vapors	1 对/包 1 pair/bag
N75002	防护酸性气体 Acid gases	1 对/包 1 pair/bag
N75003	防护有机气体及蒸气, 酸性气体 Organic Vapors + Acid gases	1 对/包 1 pair/bag
N75004	防护氨气及甲胺类碱性气体 Ammonia + Methylamine	1 对/包 1 pair/bag
N750052	防护汞蒸气和氯气, 带ESLI寿命终点指示功能 Mercury vapor + Chlorine, with ESLI function	1 对/包 1 pair/bag
75SC	Defender多用滤盒, 防护多种气体, 如有机气体及蒸气, 酸性气体, 氨气及甲胺类碱性气体和甲醛 Multi-use, including Organic Vapors, Acid gases, Ammonia, Methylamine and Formaldehyde	1 对/包 1 pair/bag
7581P100	防护有机气体及蒸气, 颗粒物 Organic Vapors + particulates	1 对/包 1 pair/bag
7582P100	防护酸性气体, 颗粒物 Acid gases + particulates	1 对/包 1 pair/bag
7583P100	防护有机气体及蒸气, 酸性气体, 颗粒物 Organic Vapors + Acid gases + particulates	1 对/包 1 pair/bag
7584P100	防护氨气及甲胺类碱性气体, 颗粒物 Ammonia + Methylamine + particulates	1 对/包 1 pair/bag
75852P100	防护汞蒸气和氯气, 颗粒物, 带ESLI寿命终点指示功能 Mercury vapor + Chlorine + particulates, with ESLI function	1 对/包 1 pair/bag
75SCP100	Defender多用滤盒, 防护有机气体及蒸气, 酸性气体, 氨气及甲胺类碱性气体和甲醛, 颗粒物 Multi-use, including Organic Vapors, Acid gases, Ammonia, Methylamine and Formaldehyde + particulates	1 对/包 1 pair/bag

N 系列防尘滤棉及滤盒/滤棉配件

N series particulate filter and accessories



7506N95



75FFP100



N750027



N750029



7506N99



N750015



N750035



7506R95



7580P100

订货号 Ref	名称 Name	描述 Description	包装规格 Package
7506N95	N95滤棉 N95 filter	防护非油性颗粒，过滤效率高于95% Protective against non-oil particulates, 95% efficiency	10片/包 10 pcs / bag
7531N95	N95滤棉组合（含7506N95滤棉，N750027滤棉盖，N750015滤棉固定器） N95 filter set (including 7506 N95 filter, N750027 filter cover, N750015 filter holder)	防护非油性颗粒，过滤效率高于95% Protective against non-oil particulates, 95% efficiency	1 对/包 1 pair/bag
7506N99	N99滤棉 N99 filter	防护非油性颗粒，过滤效率高于99% Protective against non-oil particulates, 99% efficiency	10片/包 10 pcs / bag
7531N99	N99滤棉组合（含7506N99滤棉，N750027滤棉盖，N750015滤棉固定器） N99 filter set (including 7506 N99 filter, N750027 filter cover, N750015 filter holder)	防护非油性颗粒，过滤效率高于99% Protective against non-oil particulates, 99% efficiency	1 对/包 1 pair/bag
7506R95	R95滤棉 R95 filter	防护非油性及油性颗粒，过滤效率高于95% Protective against non-oil and oil particulates, 95% efficiency	10片/包 10 pcs / bag
7580P100	P100滤棉 P100 filter	防护非油性及油性颗粒，过滤效率高于99.97% Protective against non-oil and oil particulates, 99.97% efficiency	1 对/包 1 pair/bag
75FFP100	P100滤棉，扁平式 P100 filter, flat shape	防护非油性及油性颗粒，过滤效率高于99.97% Protective against non-oil and oil particulates, 99.97% efficiency	1 对/包 1 pair/bag
N750015	滤盒/滤棉固定底座 filter holder	适用于7506N95，7506N99，7506R95滤棉。 需要与N750027组合使用	1个/包 1 unit/bag
N750027	滤盒/滤棉盖 (7506N95，7506N99，7506R95专用) filter cover (for 7506N95, 7506N99, 7506R95)	用于将滤棉与防毒滤盒进行组合。如仅使用滤棉，需要同时选配N750015固定底座 To connect the filter and gas cartridge. If only the filter is used, the N750015 holder should also be attached together	1个/包 1 unit/bag
N750029	滤盒/滤棉盖（750080P100专用） filter cover (for 750080P100)	适用于7580P100 For 750080P100	1个/包 1 unit/bag
N750035	滤盒/滤棉盖（75FFP100专用） filter cover (for 75FFP100)	可将75FFP100滤棉与防毒滤盒进行组合。 (75SC Defender滤盒除外) To connect 75FFP100 with gas cartridge. (except for the 75SC defender cartridge)	1个/包 1 unit/bag

S 系列滤盒 (NIOSH标准)

S series cartridges (NIOSH standard)

订货号 Ref	描述 Description	包装规格 Package
B100100	防护有机气体及蒸气 Organic Vapors	6个/包 6 pcs/box
B100200	防护酸性气体 Acid gases	6个/包 6 pcs/box
B100300	防护有机气体及蒸气, 酸性气体 Organic Vapors + Acid gases	6个/包 6 pcs/box
B100400	防护氨气及甲胺类碱性气体 Ammonia + Methylamine	6个/包 6 pcs/box
100600	防护汞蒸气和氯气, 带ESLI寿命终点指示功能 Mercury vapor + Chlorine, with ESLI function	6个/包 6 pcs/box
100800	防护多种气体 Multi-gases	6个/包 6 pcs/box
106010	N95滤棉 N95 filter	6个/包 6 pcs/box
105005	P100 滤盒 P100 filter	10个/包 10 pcs/box
105810	多种气体+P100颗粒防护滤盒 Multi-gases + P100 filter	6个/包 6 pcs/box
140174	滤棉支架 Filter holder	6个/包 6 pcs/box

B290系列滤盒

B290 series cartridges



订货号 Ref	描述 Description	包装规格 Package
G100	防护有机气体及蒸气 Organic Vapors	6个/包 6 pcs/box
G104	防护有机气体及蒸气, 酸性气体 Organic Vapors + Acid gases	6个/包 6 pcs/box
G106	防护氨气及甲胺类碱性气体 Ammonia + Methylamine	6个/包 6 pcs/box
G110	防护多种气体 Multi-gases	6个/包 6 pcs/box
F200	N95滤棉 N95 filter	20个/包 20 pcs/box

铝制防毒防尘滤罐系列, EN 标准

Canisters for gas and particulate protection, EN Standard



订货号 Ref.	类型 Type	描述 Description
A168097	A2B2E2K2	有机和无机气体及蒸气, 酸性气体, 氨及有机氨衍生物 Organic and inorganic gases and vapors, Acid gases, Ammonia
A168103	A2B2P3	有机和无机气体及蒸气, 颗粒物 Organic and inorganic gases and vapors + particulates
A168104	A2B2E2K2P3	有机和无机气体及蒸气, 酸性气体, 氨及有机氨衍生物, 颗粒物 Organic and inorganic gases and vapors, Acid gases, Ammonia + particulates
A168112	A2B2E2K2P3Hg	有机和无机气体及蒸气, 酸性气体, 氨及有机氨衍生物, 汞蒸气, 颗粒物 Organic and inorganic gases and vapors, Acid gases, Ammonia + particulates
1781095	CS	防催泪瓦斯 CS
1783040	A2B2P3	有机和无机气体及蒸气, 颗粒物 Organic and inorganic gases and vapors + particulates
1783140	Hg	汞 Hg
1784000	A2B2E2K2P3	有机和无机气体及蒸气, 酸性气体, 氨及有机氨衍生物, 颗粒物 Organic and inorganic gases and vapors, Acid gases, Ammonia + particulates
1785040	A2B2	有机和无机气体及蒸气 Organic and inorganic gases and vapors
1785622	A2B2E2K1P3 NBC	有机和无机气体及蒸气, 酸性气体, 氨及有机氨衍生物, 颗粒物 Organic and inorganic gases and vapors, Acid gases, Ammonia + particulates
1786000	P3	防护非油性及油性颗粒 Protective against non-oil and oil particulates
1786200	碘及放射性颗粒	防护碘及放射性颗粒 Iodine and radioactive particulates

塑料防毒防尘滤罐系列, EN 标准

Canisters for gas and particulate protection, EN Standard



订货号 Ref.	类型 Type	描述 Description
BC1788000	A2 250cc	防护有机气体及蒸气 (沸点高于65°C) Organic gases and vapors(boiling point >65°C)
BC1788010	B2 250cc	防护无机气体和蒸气 Inorganic gases and vapors
BC1788020	K2 250cc	防护氨及有机氨衍生物 Ammonia
BC1788075	A2B2 250cc	有机和无机气体及蒸气 Organic and inorganic gases and vapors
BC1788005	A2P3 250cc	防护有机气体及蒸气 (沸点高于65°C), 颗粒物 Organic gases and vapors(boiling point >65°C)+particulates
BC1788015	B2P3 250cc	防护无机气体和蒸气, 颗粒物 Inorganic gases and vapors + particulates
BC1788025	K2P3 250cc	防护氨及有机氨衍生物, 颗粒物 Ammonia + particulates
BC1788070	A2B2P3 250cc	有机和无机气体及蒸气, 颗粒物 Organic and inorganic gases and vapors + particulates
BC1788150	A2B2E2K2 450cc	有机和无机气体及蒸气, 酸性气体, 氨及有机氨衍生物 Organic and inorganic gases and vapors, Acid gases, Ammonia
BC1788155	A2B2E2K2P3 450cc	有机和无机气体及蒸气, 酸性气体, 氨及有机氨衍生物, 颗粒物 Organic and inorganic gases and vapors, Acid gases, Ammonia + particulates

电动送风系统及长管呼吸系统 PAPR and SAR

听力防护系列
Hearing Protection

眼部防护系列
Eye & Face Protection

呼吸防护系列
Respiratory Protection

气检仪器系列
Instrumentation

手部防护系列
Protective Gloves

防护服系列
Protective Clothing

足部防护系列
Foot Protection

坠落防护系列
Fall Protection

电力防护系列
Electrical Safety Protection

消防救援防护
First Responder Products

Compact Air® 电动送风呼吸系统

- 可用于气体、蒸汽、固体及液体颗粒防护。为同类产品中最值得信赖的一款产品，产品市场超过12年。经CE认证，符合EN12941及EN12942标准
- 适用作业环境：喷漆/制药/研磨/焊接/化工处理/铸造
 - 便携包装设计，仅重1.35公斤。结构紧凑灵巧，电池更换容易，携带轻松便捷
 - 送风量160-200升/分钟
 - NiMH电池（镍氢），可反复充电500次。并可连续作业8小时
 - 鼓风机及电池独立定位，腰带按人体工程科学设计，将重量均匀分配于腰部，就算长时间佩戴也不会让用户感觉额外负担
 - 接软管及接头可按客户要求定制，结实耐用。并有螺纹及卡口两种接头可供选配
 - 配有独立平衡风扇，可延长发动机寿命
 - 电池及鼓风机皆为防水喷溅设计，无清洁死角，清洁维护方便
 - 并可与多款霍尼韦尔头罩，头盔或面具配合使用



订货号：A150102-00

Compact Air® Plus 为 Compact Air® 的升级版。与 Compact Air® 相比：

- 可通过电量来自动调节舒适的流量
- 可自动开始、控制和校准
- 恒流受控气流 150l/min，可连续作业10小时
- 兼具声音和视觉报警

AIRBELT® 电动送风呼吸系统

- 可用于固体及液体颗粒防护。经CE认证，符合EN12941及EN12942标准
- 适用作业环境：制药/打磨/焊接/铸造
 - 便携包装设计，仅重0.9公斤。结构紧凑灵巧，电池更换容易，携带轻松便捷
 - 无级变速，送风量160升/分钟
 - NiMH电池（镍氢），可反复充电500次。用于面罩可连续作业10小时，用于头罩可连续作业5小时
 - 鼓风机及电池独立定位，腰带按人体工程科学设计，将重量均匀分配于腰部，就算长时间佩戴也不会让用户感觉额外负担
 - 电子警报装置
 - 连接软管及接头可按客户要求选择，结实耐用。并有螺纹及卡口两种接头可供选配
 - 配有独立平衡风扇，可延长发动机寿命
 - 电池及鼓风机皆为防水喷溅设计，无清洁死角，清洁维护方便
 - 并可与多款霍尼韦尔头罩，头盔或面具配合使用



订货号：A150050

订货号	产品名称	软管接头类型	配合产品	便携箱	Nimh 镍氢电池	充电器	空气流量计	Pvc 腰带	软管	低流量及电量报警器
COMPACT AIR® 系列										
A150102-00	COMPACT AIR® 系列 卡口式接头电动送风系统	卡口式	头罩	有	有	智能型	有	有	有	无
A150103-00	COMPACT AIR® 系列 螺口式接头电动送风系统	螺口式	面罩	有	有	智能型	有	有	有	无
A150140-00	COMPACT AIR® ATEX 卡口式接头防爆电动送风系统	卡口式	头罩	有	有	智能型	有	有	有	无
A150202	COMPACT AIR® PLUS 系列 卡口式接头电动送风系统	卡口式	头罩	有	有	智能型	有	有	有	声音/ 视觉兼具
A150203	COMPACT AIR® PLUS 系列 螺口式接头电动送风系统	螺口式	面罩	有	有	智能型	有	有	有	声音/ 视觉兼具
AIRBELT® 系列										
A150050	AIRBELT® 卡口式接头电动送风系统	卡口式	头罩	有	有	普通型	无	有	有	声音
A150051	AIRBELT® 螺口式接头电动送风系统	螺口式	面罩	有	有	普通型	无	有	有	声音
A160054-03	AIRBELT® 配套使用 P3 滤芯， 每组 3 个。	/	/	/	/	/	/	/	/	/

Compact Air Powered Air Purifying

- CE certified, EN12941 and EN12942 standard.
 - The COMPACT AIR powered respirator is used in combination with EN 148-1 particle- and or gas filters. The contaminated air is drawn through 3 filters and supplies a continuous flow of clean air to the wearer's headpiece (hood or mask).
 - Application: Painting, Welding, grinding, chemical handling, cleaning, etc..
 - Weight: 1.35 kilogram, without filters. Both battery and blower are separate which makes it easy to change the battery during the working day.
 - Airflow: 160 - 200 l/min, depending on type of filters
 - Battery: NiMH (rechargeable). More than 500 times rechargeable and 8 hours working time.
 - Blower and battery are positioned separately. Belt is well designed to balance the weight on the waist which avoids extra load even in long working period.
 - Limits for use: Do not use in confined spaces or places with a oxygen level <19%
 - Can be used with various types of hoods, helmets and masks.
- Compact Air Plus is the updated version of Compact Air which features:
- Automatic operating, controlling and adjusting.
 - Constant air flow of 150L/min and 10 hours working time.
 - Audio and visual warning for air flow and batter



Ref.:A150102-00



Ref.:A150050

Airbelt Powered Air Purifying

- CE certified, EN12941 and EN12942 standard.
- Application: Pharmaceuticals, Welding, grinding, etc.
- Compact case weighting only 0.9 kg which is easy to carry and store.
- Constant air flow 160 L/min
- Battery: NiMH (rechargeable). More than 500 times rechargeable. More than 10 hours working time for mask and 5 hours for hoods
- Blower and battery are positioned separately. Belt is well designed to balance the weight on the waist which avoids extra load even in long working period.
- Audio warning for air flow defects.
- Threaded and bayonet connection for different headtops.
- Can be used with various types of hoods, helmets and masks.

Ref.	Name	Hose Connection	Headtops	Case	Nimh Battery	Charger	Airflow Indicator	Pvc belt	Hose	Low air flow and battery warning
Compact Air series										
A150102-00	Compact air papr with bayonet Connection	Bayonet Connection	Hood	Y	Y	Intelligent	Y	Y	Y	N
A150103-00	Compact air papr with threaded Connection	Threaded Connection	Mask	Y	Y	Intelligent	Y	Y	Y	N
A150140-00	Compact air ayex papr with bayonet connection	Bayonet Connection	Hood	Y	Y	Intelligent	Y	Y	Y	N
A150202	Compact air plus papr with bayonet connection	Bayonet Connection	Hood	Y	Y	Intelligent	Y	Y	Y	Audio and visual
A150203	Compact air plus papr with bayonet connection	Threaded Connection	Mask	Y	Y	Intelligent	Y	Y	Y	Audio and visual
Airbelt series										
A150050	Compact air papr with bayonet Connection	Bayonet Connection	Hood	Y	Y	Normal	N	Y	Y	Audio
A150051	Compact air papr with threaded Connection	Threaded connection	Mask	Y	Y	Normal	N	Y	Y	Audio
A160054-03	P3 filter for airbelt, 3 pcs/package	/	/	/	/	/	/	/	/	/



订货号: A160050-23

压缩空气过滤装置(AFU)

- 符合EN12021标准。适用于喷漆/制药/研磨/焊接/化工/喷砂作业环境
- 三重过滤，彻底过滤油水、颗粒及气体蒸汽
- 流量900l/min，入口压力5-10bar。含3个CEJN接头，最多可同时供三个工人使用
- 重量为12kg。可移动或固定使用
- 可与多种头罩或头盔配合使用，为用户提供完整解决方案。

订货号	产品说明	包装
A160050-23	压缩空气过滤器装置，带油水分离器，2个P3过滤和超大活性炭过滤器(800g)，包括3个标准的CEJN快插式接头	1件

四路供气过滤系统



订货号: BC17 635 25

DE 4

- 配有三个过滤器，过滤水份，油份和直径大于5微米的固体气溶胶
- A级活性炭层，C强过滤能力，滤除更细小油蒸气 (>0.01 微米) 和气味
- 网路压力必须在5-12bars之间
- 可同时供四人使用
- 每个输气口最小气流量为600L/分钟，每个输气口最大气流量为1200L/分钟
- 自动净化功能
- 网路输入接口有：例如 STAUBLI RBE11
- 网路输出接口（与其他安全防护产品相联的）有：例如 STAUBLI RBE 6
- 材料：铸铝
- 重量：9 kg

订货号	产品说明	包装
BC1763525-4	DE4过滤站组合配置（供四人使用）	件
BC1763525-3	DE4过滤站组合配置（供三人使用）	件
BC1763525-2	DE4过滤站组合配置（供二人使用）	件
BC1763525-1	DE4过滤站组合配置（供一人使用）	件



订货号: 86600

空气压缩机-美标款

- 将洁净气源通过压缩机及配套的长管输送到需要加以防护的环境，供恒流式供气呼吸系统使用
- 符合NIOSH标准，适用于喷漆/制药/研磨/焊接/化工/喷砂等多个行业
- 重量轻，携带方便，可灵活应用于多个工作场合
- 可与多款面罩或供气式专用头罩配合使用，为客户提供完整的解决方案

订货号	产品说明	功率	重量	最大CFM值	输出空气流量
86600	1/4马力，1人用空气压缩机。可连接1个全面罩，不可连接头罩	1/4 H.P.	15kg	5	0~140L/min
86610	3/4马力，2人用空气压缩机。可连接2个全面罩，或可连接1个头罩	3/4 H.P.	25kg	10	0~280L/min
86630	1-1/2马力，3人用空气压缩机。可连接3个全面罩，或可连接2个头罩	1 1/2 H.P.	50kg	20	0~560L/min



Ref.:A160050-23

Compressed Airline Filter Unit(AFU)

- Conforms to EN12021.
- Consists of a regulator with oil- & water separator and an interchangeable main filter including 2 P3 filters and a 800 gram carbon filter.
- Airflow: 900 l/min max
- Inlet Pressure: 5 bar (min) - 10 bar (max)
- Equipped with 3 CEJN outgoing couplings.
- Weight: 12kg
- For respiratory protective devices including hoods and shotblasting helmets

Ref.	Description	Package
A160050-23	Compressed Airline Filter Unit, 3 connections. With a regulator with oil- & water separator and an interchangeable main filter including 2 P3 filters and a 800 gram carbon filter.	1 set

4-outlet air filtration unit



Ref.: BC17 635 25

DE 4

- Equipped with 3 filters to remove water, oil and solid aerosols > 5 microns
- Class A carbon layer to remove the finest oil vapours (> 0.01 micron) and odours
- Network pressure must be between 5 and 12 bars
- Possible supply for 4 pieces of equipment simultaneously
- Minimum flow rate guaranteed for each outlet – 600 litres/min
Maximum flow rate guaranteed for each outlet 1200 litres/min
- Automatic purge
- Connection to Network: STAUBLI RBE 11
- Connection to PPE: STAUBLI RBE 6
- Material: cast aluminium
- Weight: 9 Kg

Ref.	Description	Package
BC1763525-4	DE4 Filtration System(For Four Persons)	1 Unit
BC1763525-3	DE4 Filtration System(For Three Persons)	1 Unit
BC1763525-2	DE4 Filtration System(For Two Persons)	1 Unit
BC1763525-1	DE4 Filtration System(For One Person)	1 Unit



Ref.:86600

Ambient Air pump--US standard

- Conforms to NIOSH standards.
- Solid performance in applications such as painting, cleaning, sanding or chemical handling operations.
- Lightweight, flexibility to be used at multiple sites, or stored when not in use.
- Available to provide customers a complete supplied air system.

Ref.	Description	Power	Weight	Max CFM	Air flow
86600	1/4 HP Ambient Air Pump for 1 person. One mask connection, not for hood use	1/4 H.P.	15kg	5	0~140L/min
86610	3/4 HP Ambient Air Pump for 2 persons Two masks connection, or one hood connection	3/4 H.P.	25kg	10	0~280L/min
86630	1-1/2 HP Ambient Air Pump for 3 persons Three masks connection, or two hoods connection	1 1/2 H.P.	50kg	20	0~560L/min



订货号 Ref.: PA101



订货号 Ref.:PA111

PRIMAIR 轻型通风头罩 Primair Loose Fitting hood

- 符合NIOSH标准
- 霍尼韦尔Primair 系列头罩结构轻巧，PA111/PA121重量仅为180g，PA101重量不超过100g
- 配有可调节的头箍和棘轮，帮助使用者轻松固定头罩
- 新鲜空气通过软管输送至前额，让使用者感觉舒适，并保持面屏清洁，无雾气凝结
- 可与电动送风系统(PAPR)及压缩空气过滤系统(AFU)配合使用。与AFU配合使用时，需另行配置供气软管A161368-00
- Conforms to NIOSH standards.
- Extremely lightweight and comfortable semi-disposable airhood: PA111/PA121 180g, PA101 less than 100g.
- The disposable part is made of coated tyvek® to ensure high chemical resistance, and is easily replaced by undoing 2 pushbuttons on the side.
- Headband and airduct reusable, reduces costs
- Airduct takes air to the visor, no misting up, no cold air on the wearers head

订货号 Ref.	产品名称 Name	覆盖部件 Cover	标准 Standard	防护因数 APF	材质 Material	尺寸 Size	包装 Package
PA101	Primair头罩 Primair hood	头部覆盖(耳部不覆盖) Head covered (ear is not covered)	NIOSH	25	Tyvek	大/中/小 L/M/S	1个 1 unit
PA111	Primair Plus全覆盖型头罩 Primair Plus hood	头部及肩部全覆盖 Head and shoulder covered	NIOSH	1000	Tyvek	均码 All	1个 1 unit
PA121	Primair Plus全覆盖型头罩，防化学溅型 Primair hood	头部及肩部全覆盖 Head and shoulder covered	NIOSH	1000	Tyvek材质含Saranex涂层 Tyvek with Saranex coating	均码 All	1个 1 unit



订货号 Ref.:A114106



订货号 Ref.:A114052

JUNIOR A 轻型通风头罩 JUNIOR A light duty airhood

- 符合EN12941 或EN1835标准。重量仅为550g
- 全面覆盖式设计，透明面屏，确保使用者拥有佳视野及光线，并可完全阻隔喷溅危害
- 顶部头罩为抛弃型，按钮拆卸。面屏使用弹簧安装系统，更换方便
- 内衬密封体柔软贴合面部，易清洗。并可防止空气进入耳部，提高使用者舒适感
- Junior A-Combi 为Junior A头罩与内置头盔的组合，保护头部免受机械伤害
- VL 系列为电动送风系统(PAPR) 配套款，PL 系列为压缩空气过滤系统(AFU)配套款
- Conforms to EN 12941 and EN 1835.
- Weight: only 550g
- Light duty full transparent airhood with plastic clamps for disposable visors and safety helmet.
- Full-face clear visor system allows light in and wide field of vision
- Full face protection including chin and brow guard
- Soft, elastic and washable face seal
- Unique system of spring loaded clamps for disposable visors.
- Junior A-Combi is Junior A incorporated with an inner helmet to protect the head from mechanical impacts
- For use with PAPR (-vl) or Airline Filter Unit (AFU) (-pl)

订货号 Ref.	产品名称 Name	安全帽 Helmet	配合使用产品 Compatible system	标准 Standard	防护因数 NPF	包装 Package
A114106	JUNIOR A-vl通风头罩 JUNIOR A-vl airhood	否 N	电动送风呼吸系统 PAPR	EN12941	50	1个 1 unit
A114052	JUNIOR A-pl通风头罩 JUNIOR A-pl airhood	否 N	压缩空气过滤系统 AFU	EN1835	50	1个 1 unit
A114300	JUNIOR A-Combi-vl通风头罩 JUNIOR A-Combi-vl airhood	是 Y	电动送风呼吸系统 PAPR	EN12941	10	1个 1 unit
A114330	JUNIOR A-Combi-pl通风头罩 JUNIOR A-Combi-pl airhood	是 Y	压缩空气过滤系统 AFU	EN1835	50	1个 1 unit



订货号 Ref.:A114201

JUNIOR B 重型通风头罩 Heavy Duty airhood JUNIOR

- 轻质斗篷式设计，同时防护头部和肩部
- 双层面屏设计，外置抛弃式面屏可以保护内置主面屏，防止因外力或飞溅而造成主面屏损坏
- 颈部密封佩戴舒适，易清洗
- 通风管道均匀传输空气至面罩内部，防止雾气凝结或传入冷空气
- 较高的安全系数
- JUNIOR B-Combi 为JUNIOR B 头罩与内置头盔的组合，保护头部免受机械伤害
- VL系列为电动送风系统(PAPR)配套款，PL系列为压缩空气过滤系统(AFU)配套款
- Heavy duty airhood with PU hood and visor clamps for disposable visors. The Combi version also includes a safety helmet.
- Flexible and lightweight airhood with a Polyurethane cape that covers the head, neck and shoulders.
- Disposable visors, fitted over the hoods main visor, protect against damage and/or splashes.
- A changeable and washable neck seal ensures a very high protection level.
- The combi version has an integral safety helmet.
- For use with COMPACT AIR & AIRBELT (-vl) or Airline Filter Unit (AFU) (-pl)

订货号 Ref.	产品名称 Name	安全帽 Helmet	配合使用产品 Compatible system	头罩材料 Hood material	标准 Standard	防护因数 NPF	包装 Package
A114400	JUNIOR B-vl通风头罩 JUNIOR B-vl airhood	否 N	电动送风呼吸系统 PAPR	PU	EN12941	50	1 个 1 unit
A114430	JUNIOR B-pl通风头罩 JUNIOR B-pl airhood	否 N	压缩空气过滤系统 AFU	PU	EN1835	200	1 个 1 unit
A114201	JUNIOR B-Combi-vl通风头罩 JUNIOR B-Combi-vl airhood	是 Y	电动送风呼吸系统 PAPR	氯丁橡胶 Neoprene	EN12941	10	1 个 1 unit
A114230	JUNIOR B-Combi-pl通风头罩 JUNIOR B-Combi-pl airhood	是 Y	压缩空气过滤系统 AFU	PU	EN1835	200	1 个 1 unit



订货号 Ref.:A130130-00



订货号 Ref.:A133130-00

COMMANDER 和 PANORAMA 喷砂头盔 Commander and Panorama Welding

- 采用玻纤加强聚酯材料制成，外覆霍尼韦尔特有橡胶涂层，将砂砾回弹噪音降至最低，空气传输均匀，确保使用者佩戴舒适，安全系数高达1000
- 黄色安全流量计可以显示是否有足够的空气输入头盔，提高安全性能
- 外置金属网及抛弃型面屏可以保护内置主面屏不受到外力损坏，并且无需摘下头盔就能轻松更换
- 佩戴舒适，颈部密封圈可以洗涤
- COMMAMDER 为集中视野设计，防止干扰
- PANORAMA 为特大宽屏设计，确保 佳视野
可与压缩空气过滤系统 (AFU) 配合使用。与 AFU 配合使用时，需另行配置供气软管 A161368-00
- Made of glass fibre re-enforced polyester equipped with rubber coating that limits the sounds of rebounding blast particles to a minimum.
- Provides the user with a high protection by a comfortable overpressure with a hood.
- The yellow airflow indicator shows whether sufficient air is being passed into the shot blasting helmet.
- The wire mesh screen and the disposable visor protect the main visor and can be easily exchanged.
- An exchangeable cotton neck seal ensures comfort and a high protection factor.
- A cape or jacket, available in leather, bisonyl or cotton, protects the user's chest, back, and shoulders.
- Commander is designed as centered visor to avoid interference.
- Panorama is designed as wide visor to ensure the best vision.
- Can be used with AFU system which needs another air hose A161368-00.

订货号 Ref.	产品名称 Name	面屏 Visor	头罩材料 Hood material	标准 Standard	防护因数 NPF	包装 Package
A130130-00	PANORAMA 喷砂头盔，皮质披肩 Shotblasting Helmet PANORAMA, with leather cape	特大宽屏 wide visor	玻纤加强聚酯，橡胶涂层 fibre re-enforced polyester, rubber coating	EN271	1000	1 个 1 unit
A130230-00	PANORAMA 喷砂头盔，Bisonyl 披肩 Shotblasting Helmet PANORAMA, with Bisonyl cape	特大宽屏 wide visor	玻纤加强聚酯，橡胶涂层 fibre re-enforced polyester, rubber coating	EN271	1000	1 个 1 unit
A133130-00	COMMANDER 喷砂头盔，皮质披肩 Shotblasting Helmet COMMANDER, with leather cape	集中视野 centered visor	玻纤加强聚酯，橡胶涂层 fibre re-enforced polyester, rubber coating	EN271	1000	1 个 1 unit
A133230-00	COMMANDER 喷砂头盔，Bisonyl 披肩 Shotblasting Helmet COMMANDER, with Bisonyl cape	集中视野 centered visor	玻纤加强聚酯，橡胶涂层 fibre re-enforced polyester, rubber coating	EN271	1000	1 个 1 unit

适用于AFU系统
Compatible with AFU System



订货号 Ref.:A161250

订货号 Ref.	产品名称 Name	符合标准 Standard	软管尺寸 Size	接头 Coupling	材质 Material	防静电 Anti-static	包装 Package
A161250	黑色轻型 Black, light	EN139	10米, 内径9毫米 10m, 9mm I.D.		外层PVC, 内层丁腈橡胶 outside PVC, inside Nitrile rubber	否 N	1套 1 set
A161253	黑色重型 Black, heavy	EN139	10米, 内径9毫米 10m, 9mm I.D.	CEJN 快插式 双保险接头	外层丁腈橡胶, 内层丁腈橡胶 outside Nitrile rubber, inside Neoprene	是 Y	1套 1 set
A161254	黑色重型 Black, heavy	EN139	20米, 内径9毫米 20m, 9mm I.D.	CEJN quick connection with dual safety lock	外层丁腈橡胶, 内层丁腈橡胶 outside Nitrile rubber, inside Neoprene	是 Y	1套 1 set
A161255	黑色重型 Black, heavy	EN139	30米, 内径9毫米 30m, 9mm I.D.		外层丁腈橡胶, 内层丁腈橡胶 outside Nitrile rubber, inside Neoprene	是 Y	1套 1 set

轻型及重型供气软管—欧标款 Light and heavy duty air hose

- 符合EN139标准
- 可以支持轻型、重型头罩及喷砂头罩
- 有轻型和重型两款可供选择
- EN 139 standard
- Can be connected with light, heavy hoods and shotblasting helmet
- Light and heavy type for selection



订货号 Ref.:A150275-01

VORTEX 涡流管—欧标款 Vortex Air Conditioner

- 在供气式长管呼吸系统中, 可与头罩类产品配合使用, 用于冷却或加热空气, 提高用户舒适性
- 轻巧, 紧凑型的设计, 为客户提供 佳佩戴舒适度
- 无需耗电, 制冷剂或其他化学试剂即可改善温度。空气加热或冷却的范围为 $\pm 20^{\circ}\text{C}$
- Airconditioner for compressed air to warm-up or cooldown the users breathing air in kinds of helmets and airhoods or in full chemical suits to control the internal temperature.
- The temperature ranges up to $\pm 20^{\circ}\text{C}$ cooler or warmer than the inlet temperature.
- No moving parts, freon or chemicals and easily controlled, maintenance free.
- Compact, lightweight and highly reliable.
- No spark / explosion hazards.

订货号 Ref.	产品名称 Name	配套产品 Compatible product	注明 Notes	包装 Package
A150275-01	Vortex涡流管和软管组合 Vortex air conditioner combined with air hose	A160050-23	腰带需单独选购 Belt must be ordered separately	1套 1 set

适用于DE4系统
Compatible with DE4- System



订货号 Ref.: 17 629 83

MC95 With EPDM Panoramasque

- 调节和输送由压缩空气装置提供的持续气流
- 可与EPDM黑面罩直接相连
- C大视野
- C强的密封性, 佩戴舒适, 重量轻, 高呼吸容量 (降低呼吸阻力及疲劳程度)
- 气流调节量: 120L/分-300L/分
- 最小输入气压: 5 bars
- Compressed air device with continuous flow
- Screws directly onto the EPDM Panoramasque
- Very wide field of vision (methacrylate lens)
- Ultra tight, comfortable, lightweight, high respiratory capacity
- Flow adjustment from 120 to 300 litres/min
- Supply: minimum 5 bars

适用于空气压缩泵——美标款
Compatible with ambient air pump— American standard



订货号 Ref.:88800H

订货号 Ref.:888050

供气长管及接头组合 - 美标款 Air hoses and connectionsr

- 符合NIOSH标准
- 可以支持霍尼韦尔NIOSH标准的头罩、面罩，配合空气压缩泵及供气长管使用
- Conforms to NIOSH standards.
- Quick connect couplers for connecting the air supply hose to hood or facepiece

订货号 Ref.	产品名称 Name	符合标准 Standard	包装 Package
888050	供气软管, 1/2"内径, 50英尺长 50' Air Hose, 1/2" I.D.	NIOSH	1 套 1 set
888100	供气软管, 1/2"内径, 100英尺长 100' Air Hose, 1/2" I.D.	NIOSH	1 套 1 set
88800H	快插式接头组合, 1/2"内径 Quick connection set, 1/2" I.D.	NIOSH	1 套 1 set



订货号 Ref.:88800HV

85300系列配套专用涡流管 - 美标款 85300 series Vortex Air Conditioner - US standard

- 为选配产品，可以冷却或加热空气，提高用户舒适性。空气加热或冷却的范围为±17°C。配有快插式接头
- Airconditioner for compressed air to warm-up or cool down the users breathing air to improve the comforts. The temperature ranges up to ±17°C cooler or warmer than the inlet temperature. Equipped with a quick connection coupler

订货号 Ref.	产品名称 Name	配套产品 Compatible product
88800HV	涡流管, 1/2"英寸内径 Vortex Air Conditioner, 1/2" I.D.	85300系列头罩 85300 hood



订货号 Ref.: CF2007

长管适配器 CF2007

- 与半面罩或全面罩配套使用时，需另行选配长管适配器CF2007。将面罩、供气长管与压缩泵连接为整体的供气式长管呼吸系统
- Airline Adapter to convert North air-purifying face pieces to supplied air. Includes breathing tube, waist belt and adjustable flow control valve.



移动供气源 Compressed Air Trolley

- 用于长时间工作的自给式呼吸装置。带有2套呼吸装置（面罩+供气阀），绕有30米软管的轮盘，4个充装了30MPa压缩空气的气瓶
- 通过不同的选择可装配含2L逃生呼吸器的逃生装置
- 逃生装置内涵自动气源切换阀，在出现意外的情况下自动切换至逃生呼吸器
- For narrow spaces; long time working condition---supplied air system.
- Equipped with: 2 breathing packages (mask+ demand valve) 30 meters long pipe, 4 fully filled compressed carbon cylinders
- Escape SCBA system is optional, system come with a automatic switcher valve which can realize the automatic switch to escape SCBA when continuous air supply cannot working

SKU	描述	移动小车	PANO 面罩 + 供气阀	腰带供气 系统	逃生系统	气瓶
BC1766010	移动小车全配型 (含 4个Luxfer 6.8L气瓶)	x1	x2	x2	x2	6.8L Luxfer气瓶 x 4
BC1766011	移动小车全配型 (含 4个国产 6.8L气瓶)	x1	x2	x2	x2	6.8L 国产气瓶 x 4
BC1766012	移动小车全配型 (含 4个Luxfer 9.0L气瓶)	x1	x2	x2	x2	9L Luxfer气瓶 x 4
BC1766013	移动小车标准型 (不含气瓶)	x1	x2		x2	无
BC1766014	移动小车经济型 (不含气瓶)	x1	x2	x2		无
BC1766015	移动小车经济型 (不锈钢车体, 不含气瓶)	x1 (不锈钢)	x2	x2	无	

升级套装

BC1766500 逃生系统升级套装 (用于经济型升级至标准型或全配型)

SKU	Description	Air trolley	PANO mask +demand valvesupply system (2L cylinder)	Belt air supply system (2L cylinder)	Escape SCBA	Cylinders on air trolley
BC1766010	Air trolley full equipped system (With 4 Luxfer 6.8L cylinders)	x1	x2	x2	x2	6.8L Luxfer cylinder x 4
BC1766011	Air trolley full equipped system (With 4 local 6.8L cylinders)	x1	x2	x2	x2	6.8L local cylinder x 4
BC1766012	Air trolley full equipped system (With 4 Luxfer 9.0L cylinders)	x1	x2	x2	x2	9L Luxfer cylinder x 4
BC1766013	Air trolley standard system (Without cylinder)	x1	x2		x2	N/A
BC1766014	Air trolley basic system (Without cylinder)	x1	x2	x2		N/A
BC1766015	Air trolley basic system (stainless steel air trolley Without cylinder)	x1 (stainless steel)	x2	x2		N/A

Upgrade Kit

BC1766500 Escape SCBA system for upgrade basic system to standard system or full equipped system

自给开路式压缩空气呼吸器 SCBA

听力防护系列
Hearing Protection Series

眼部防护系列
Eye & Face Protection Series

呼吸防护系列
Respiratory Protection Series

气检仪系列
Instrumentation Series

手部防护系列
Protective Gloves Series

防护服系列
Protective Clothing Series

足部防护系列
Foot Protection Series

坠落防护系列
Fall Protection Series

电力防护系列
Electrical Safety Protection Series

消防救援防护
Fire Responder Products

Warrior 系列

我们基于最终用户使用安全、快捷、舒适的每一个细节诉求，开发出了全新的符合并超越NFPA标准的杰作——Warrior系列产品，为一线消防战士提供新的利器，同时也为同行业的产品标准树立了新的标杆。

手柄

三个宽大而舒适的手柄，充分考虑佩戴手套及运输时的便利性。

Carrying Handles

Three large handles accommodate gloved hands and allow for easy transport.

Air-Pod™ 背架系统

轻便的铝质背架提供了极高的强度和极佳的稳定性。

警报器

可选的三种低气量声音警报器（铃声、平哨或者颤哨），位于用户容易觉察到的耳朵附近；在背部的可视的低气量警报器使得在嘈杂的环境中也容易识别；在正面和背面的电池状态指示灯可以在使用之前提供关键的电池信息。

Air-Pod™ Backpack

Choice of three audible low air alarms (bell, plain whistle, warbling whistle) located near the ear for easy detection by the user; visual low air alarm on back for easy identification in high-noise environments; battery status indicator on front and back for critical battery information prior to donning

气瓶固定系统

SpeedChange™ 锁紧和开锁系统保证在最恶劣的条件下能够快速更换气瓶。

Tank Band

SpeedChange™ lock and release system makes for a quick cylinder change-out under the most adverse conditions.

紧急救援小组/供应商通用的气源接口 (RIC UAC)

背架保护提供了安全特性，消除了突起点。

Rapid Intervention Crew/ Company Universal Air Connection (RIC UAC)

Protected by the backplate for safety elimination as a snag point.

一级减压器

自动防故障设计，结构简洁可靠；在背架内得到保护，以消除突起点。

First Stage Pressure Reducer

Fail-safe design is simple and reliable; protected within the backpack to eliminate snag points.

中央式电源

单一电池舱，使用四节高电量“C”型碱性电池，提供所有集成的电子设备的电力，降低更换电池的频度。

Central Power Source

Single battery compartment, utilizing four “C” alkaline batteries, for all integrated electronics simplifies and reduces frequency of battery change.

握柄

大握柄设计，即使在佩戴厚重手套的条件下也可轻易被抓到和使用。

Garb Handles

Large grab handles allow easy location and function with gloved hands.



救援索孔

可以承受1,000磅的拉力

Carabiner Attachments

Carabiner attachment points withstand up to 1,000 pounds of pull force for extrication.

背垫系统

柔软的衬垫，均匀地把重量沿着背部分布，提高了舒适度。MaxxMotion™ 独特的旋转和枢轴式设计提供了极佳的灵活性。

Hip pad

Large, flexible hip pad distributes weight evenly across the back for added comfort. Unique MaxxMotion™ swivel and pivot design delivers superior mobility.

PASS(位移报警器)

IntelliPASS™在装置前部和后部安装的声音和可视报警装置提高了被救援人员发现的机会，无论消防人员跌倒的朝向；数据记录器将记录最近发生的2,000次报警事件。

PASS Alarms

IntelliPASS™ audible and visual alarms located on front and back of unit increase chance of discovery regardless of the orientation of the fallen firefighter; data logging records the most recent 2,000 events.

TwentyTwenty® Plus CBRN 面罩

经过光学校正的防雾面屏能够提供不失真的视觉，无可比拟的周围视角；柔顺的丁基橡胶贴面提供极好的密封性、舒适性和耐用性。

TwentyTwenty® Plus CBRN Facepiece

Optically correct anti-fog lens provides distortion-free view, unparalleled peripheral vision; soft butyl rubber skirt furnishes excellent sealing ability, comfort, and durability.

抬头显示系统 (HUD)

宽幅发光二级管式显示器会自动调整亮度，提供“气表”式的读数，容易区分；外部的可视低气量报警器在嘈杂的环境中也能够轻易识别。

Heads-Up Display (HUD)

Wide-span LED-style display automatically dims or

brightens, offers “gas

style readings for easy differentiation; external visual low air alarm for easy identification in high-noise environments.



CommCommand™

扩音系统

以清晰的高保真扩音功能为特色，可选择按键或者免提操作模式。

CommCommand™ Voice Amplification System

Features clear, distortion-free voice amplification with choice of push-to-talk or hands-free operation.

CommCommand 无线射频通讯系统(RCS)

特有的数字射频系统，提供极端清晰的通讯效果；同时消除了有线系统造成的被攀挂的危险

CommCommand™ Wireless Radio Communication System (RCS)

Features digital spread spectrum radio frequency for crystal-clear communications; eliminates interface cable snag hazard.

可选配件：

气瓶

4500psig (300bar) 压力条件下的，30分钟 (4.7L) 45分钟 (6.8L) 60分钟 (9L) 三种气瓶供选择。

斯博瑞安 Pathfinder™

紧急搜救系统，通过收集SCBA上超声波发射装置的频率强度确定受伤人员的位置

他就接口：

42英寸长的中压软管配两个接头，使得消防人员可以在不断开调节阀的情况下共享他们的气源；也有可选的方便贮存袋。

T8000

- 整体欧标认证，通过严格的 EN137-2006 自给开路式压缩空气呼吸器标准
- 产品的简易设计及合理布局在研发中严格考虑到中国大范围使用者对呼吸器的使用工作习惯及工作场合
- 整套呼吸器重量只有10.4公斤(含3.8公斤气瓶)，轻便设计方便活动和长时间工作要求
- 可选配置以满足客户对他救及通讯功能的需求
- 可选Survivair 20/20plus 面罩以满足较高要求客户需求
- 产品通过 GA124-2004 及 GB/T 16556-2007 国家标准

值得信赖的呼吸器

整机严格通过连续120万次
可靠性测试，且整机性能稳定。



安全可靠的一级减压系统

- 全新一级减压阀设计，无阀针设计便于维护
- 源于欧州先进设计，结构紧凑，简捷，整个阀体重量仅为700克。
- 高效的他救接口提供和使用者相同的中压流量，满足他救时使用者的空气流量的需求。

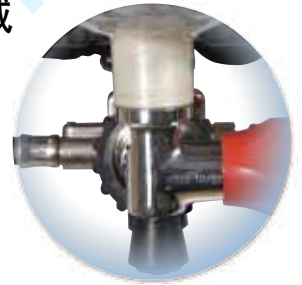

高科技高压管设计结合前置报警系统

- 高压管内置，且配置安全泄暴孔，确保使用者安全
- 报警哨前置且提供超过90dB的报警音量，确保使用者和他人能方便察觉



灵活及安全的供气阀接头

- 全新设计的Banjo连接器，方便供气阀的佩戴
- 通过Banjo连接器使中压管的位置紧贴胸前，降低佩戴者使用中压管被勾的危险。



Survivair 20/20plus 高端面罩

- 按美国NFPA（美国国家消防协会）标准生产，且符合EN标准
- 耐高温，且在低温条件下不会变硬变脆，良好的耐化学腐蚀性能
- 坚固的供气阀接口，30英尺坠落不碎裂
- 特殊防刮涂层面屏，具C级耐刮擦能力
- 立体型大视野，无视觉失真，享受完美视觉效果
- KAPTON专利材料传音膜，高效的传音效果
- 有头带和KEVLAR头网两种产品供选择满足您不同的要求



PANO 全面罩

- 适用于亚洲人脸型，配戴舒适
- 视野宽阔，安全性更高。面罩密封边缘双层设计，避免环境中的有毒有害气体侵入面罩
- 正压式设计（3毫巴），通过快速插入式接口与供气阀连接，新式呼气阀使得呼气阻力明显降低
- 配有传音膜（侧面传音膜方便使用对讲机），配有快松扳扣系统，头带调节简便
- 配有口鼻罩，降低面罩内呼出的CO₂含量
- 面罩内部气流自动冲刷面屏，以防产生雾气



Small talk 扩音系统



RCS 通讯系统

简单结构的通讯系统，提供良好的通讯效果

T8000

订货号 产品名称

标准呼吸器

SCBA805 T8000 标准呼吸器（6.8L luxfer 气瓶，PANO 面罩）

SCBA825 T8000 标准呼吸器（6.8L luxfer 气瓶，Survivair 20/20plus 面罩）

9L 呼吸器

SCBA809 T8000 标准呼吸器（9L luxfer 气瓶，PANO 面罩）

SCBA829 T8000 标准呼吸器（9L luxfer 气瓶，Survivair 20/20plus 面罩）

他救呼吸器

SCBA805T T8000 他救呼吸器（6.8L luxfer 气瓶，PANO 面罩）

SCBA825T T8000 他救呼吸器（6.8L luxfer 气瓶，Survivair 20/20plus 面罩）

SCBA809T T8000 他救呼吸器（9L luxfer 气瓶，PANO 面罩）

SCBA829T T8000 他救呼吸器（9L luxfer 气瓶，Survivair 20/20plus 面罩）

T8000 备用气瓶

BC1868427T T8000 用 Luxfer 6.8L 气瓶

BC1890327T T8000 用 Luxfer 9L 气瓶

T8000

- EN 137-2006 certified SCBA
- The SCBA design is based on considering the Chinese working environment and working habit
- Light weight, the total weight only 10.4kg (including 3.8 Kg cylinder), suit for long time wearing.
- Optional configuration available for meeting rescue purpose.
- Optional Survivair 20/20plus mask for high visibility and wide vision
- GA124-2004 and GB/T 16556-2007 certified

SCBA YOU CAN TRUST

SCBA strictly passed 1.2 million breathing tests and works stably.



High technology reducer design

- New design of reducer which is easy to maintenance and more safety and stable
- Reducer design from Europe latest technology, simple and stable, total weight only 700g
- High efficiency rescue outlet providing high air flow for rescue purpose

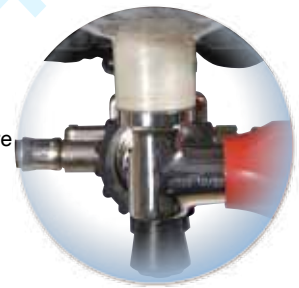

High technology HP hose with chest whistle

- Build in HP hose with exposure hole outside
- Chest whistle provide more than 90dB alarm



Flexible Banjo connector

- New Banjo connector provide more flexibility when wearing the demand valve
- Banjo connector make the MP hose more close to chest to avoid any danger of hose being hooked.



Survivair 20/20plus mask

- Meet EN 136 and NFPA standard
- Does not soften, melt, or burn in high heat or direct flame
- Does not stiffen or become brittle in cold
- Wide range of chemical resistance
- Able to withstand drop of 30 feet onto concrete without breaking
- Durable, scratch resistant lens
- Distortion-free lens with exceptional view
- Kapton® speaking diaphragm, effective local voice transmission
- Optional Head net



PANO Mask

- Especially designed for Asian people
- Panoramic field of vision
- Speech diagram
- Good anti-fog performance thanks to the cool air pulsed into the mask



Small talk

Amplifying system with loudspeaker



RCS system

Communication system with simplest parts and best communication quality, in the market, thus letting people communicate in fire fighting

T8000

SKU	Description
Basic Unit	
SCBA805	T8000 SCBA (6.8L Luxfer Cylinder, PANO Mask)
SCBA825	T8000 SCBA (6.8L Luxfer Cylinder, Survivair 20/20plus Mask)
9L Cylinder	
SCBA809	T8000 SCBA (9L Luxfer Cylinder, PANO Mask)
SCBA829	T8000 SCBA (9L Luxfer Cylinder, Survivair 20/20plus Mask)
With buddy breather	
SCBA805T	T8000 SCBA with buddy breather (6.8L Luxfer Cylinder, PANO Mask)
SCBA825T	T8000 SCBA with buddy breather (6.8L Luxfer Cylinder, Survivair 20/20plus Mask)
SCBA809T	T8000 SCBA with buddy breather (9L Luxfer Cylinder, PANO Mask)
SCBA829T	T8000 SCBA with buddy breather (9L Luxfer Cylinder, Survivair 20/20plus Mask)
T8000 Cylinder	
BC1868427T	Luxfer 6.8L Cylinder
BC1890327T	Luxfer 9L Cylinder

C900/C850



PANO 全面罩 PANO Mask

- 适用于亚洲人脸型，配戴舒适
- 视野宽阔，安全性更高。面罩密封边缘双层设计，避免环境中的有毒有害气体侵入面罩
- 正压式设计（3毫巴），通过快速插入式接口与供气阀连接，新式呼气阀使得呼气阻力明显降低
- 配有传音膜（侧面传音膜方便使用对讲机），配有快松扳扣系统，头带调节简便
- 配有口鼻罩，降低面罩内呼出的CO₂含量
- 面罩内部气流自动冲刷面屏，以防产生雾气
- Especially designed for Asian people
- Panoramic field of vision
- Speech diagram
- Good anti-fog performance thanks to the cool air pulsed into the mask



供气阀 Demand Valve:

- 独一无二的快速插接式设计，使用简便，供气迅速
- 体积小，重量轻，保证极佳的下视野
- 呼吸舒适轻松，最大供气量可达到450升/分钟以上，保证面罩内正压（3毫巴），更安全可靠
- 通过旋转式接口与中压管相连，更换方便
- Unique quick-connecting demand valve, supplies the air automatically when connected to the mask
- Small and light, good down vision
- Comfortable breathing, maximum supply flow rate is higher than 450L/MIN, always keeping a positive pressure in the mask



减压器 Pressure Reducer:

- 结构简单可靠，压力补给型，保持中压循环系统中的持续压力（7巴）及流量（>450升/分钟）
- 可扩展型，能接单瓶或双瓶
- 配有泄压安全阀，当中压回路中压力大于11巴时自动泄压，保证使用者安全
- 配有便捷式手轮，用于装卸气瓶
- 配有他救接口，可接面罩式通风头罩，供抢救第二方时呼吸用
- Simple structure, keeps the Medium Pressure system at 7 bars
- Special design, able to accept 2 cylinders
- Safety valve, to ensure that the pressure of the MP hose is always lower than 7 bars
- Additional "buddy breather": can be equipped with two masks for rescuing an endangered person



■ C900

5 ■ C900 使用 Luxfer专业碳纤维瓶:

C900 SCBA: Luxfer professional carbon cylinder

- 4.7L可使用约30分钟；6.8L可使用约45分钟；9L可使用约60分钟
- 瓶口螺纹制式：M18x1.5。符合HSE-ALFW1、HSE-AL-FW2、prEN12245标准
- 气瓶带橡胶底衬，保护气瓶表面免受损伤
- 4.7L for 30 minutes; 6.8L for 45 minutes; 9L for 60 minutes
- Connector for cylinder: M18*1.5; meets HSE-AL-FW1, HSEALFW2, PREN12245 standards
- With cylinder protection pad and bag



■ C850

■ C850 使用 高可靠性国产碳纤维气瓶:

C850 SCBA: Reliable local cylinder

- 6.8升可使用约45分钟
- 气瓶带橡胶底衬，保护气瓶表面免受损伤
- DOT-CFFC-2000标准
- 6.8L for about 45 minutes duration (actual using time)
- With cylinder protection pad
- Meets DOT standard

C900

订货号	产品名称	Description
SCBA105M	C900 自给开路式压缩空气呼吸器 (6.8L LUXFER碳瓶)	C900 SCBA (6.8L Luxfer carbon cylinder)
SCBA123M	C900 自给开路式压缩空气呼吸器 (6.8L LUXFER碳瓶带表瓶阀)	C900 SCBA (6.8L Luxfer carbon cylinder with Gauge)
SCBA124	C900 自给开路式压缩空气呼吸器 (6.8L LUXFER碳瓶双瓶)	C900 SCBA (Double 6.8L Luxfer carbon cylinders)
SCBA126	C900 正压式空气呼吸器 (9L LUXFER碳瓶)	C900 SCBA (9L Luxfer carbon cylinder)

C850

订货号	产品名称	Description
SCBA205	C850 自给开路式压缩空气呼吸器 (6.8L 国产碳瓶)	C850 SCBA (6.8L local carbon cylinder)
SCBA215	C850 自给开路式压缩空气呼吸器 (6.8L 国产碳瓶带表瓶阀)	C850 SCBA (6.8L local carbon cylinder with Gauge)

C900/C850 备用气瓶 Cylinder

订货号	产品名称	Description
BC1868427	C900 / C850 用 6.8L Luxfer 碳瓶	C900 / C850 6.8L Luxfer cylinder
BC1868527	C900 / C850 用 6.8L 国产碳瓶	C900 / C850 6.8L local carbon cylinder
1890327	C900 / C850 用 9L Luxfer 碳瓶	C900 / C850 9L Luxfer cylinder

COUGAR 空气呼吸器 SCBA

1 背架 Back Pack

- 该呼吸器 Mightylight 型背架是业内 轻巧、强度 高的一种
- 按人体工程学原理设计，选用高强度塑料和抗冲击性能优异的碳纤维注塑成型。它既防静电又能有效地隔绝高温。同时，最大限度地考虑了佩戴舒适性，骨盆支撑和宽大的折叠式腰部护翼设计大大改善了呼吸器的重量分布，更使作业活动不受任何限制
- 阻燃型的聚酯尼龙背带可以方便地从背架上卸下以便清洁维护
- The mighty-light back pack is one of the lightest and strongest in the industry.
- The design of the backpack based on the figure of the human being, the purpose is the perfect fit to the body. It also adopt the high intensity material which can not only anti the static but also isolate the high temperature. Meanwhile the comfort is another key point for this instrument the special wing design of the waist belt greatly decentralize the weight points, which improve the flexibility of the end users.
- Flame proof harness belt can be easily unpicked and washed.



2 压力表 Pressure Gauge

- 可任意角度旋转便于察看，特有的夜光显示即使夜间也可以清晰读数
- Easy to read and can be used at night

订货号 Ref.	描述 Description
SCBA305	COUGAR 自给开放式压缩空气呼吸器 45分钟 SURVIVAIR 原装碳瓶 COUGAR SCBA 45mins fully imported SURVIVAIR cylinder
SCBA325	COUGAR 自给开放式压缩空气呼吸器 45分钟 SURVIVAIR 原装碳瓶防自锁 COUGAR SCBA 45mins fully imported SURVIVAIR cylinder with locking wheel
SCBA345	COUGAR 自给开放式压缩空气呼吸器 60分钟 SURVIVAIR 原装碳瓶 COUGAR SCBA 60 mins fully imported SURVIVAIR cylinder with locking wheel

面罩 Mask

- 未来增强型硅橡胶面罩，提供了无以伦比的面部舒适性，即使在极冷、极热的情况下该面罩柔软、坚固耐用，不易老化，不会引起皮肤过敏
- 五根可调节头带，保证 佳密封
- 优化设计后的面罩镜片进一步增大了可视范围，镜片光学性能极佳，防雾，耐划伤，面罩更符合面部曲线，降低了脸部疲劳程度
- Silicone rubber Durable will not oxidize or react with Ozone
- Unsurpassed comfort, even in extreme heat or cold
- Five-strap harness and skirt with better sealing ability for better comfort and fit
- Improved lens expands the vision, with optical treatment, anti fog properties, and anti scratch abilities



供气阀 Demand Valve

二级压力调节供气阀采用专利“Air-Klic”接口技术，可以以任意角度与面罩连接，操作简单、可靠，其红色的旁通旋钮可以随时调节辅助供气流量，并在二级调节气阀失灵时提供空气或作为补充供气

The second stage adjustment adopts the patented “Air-Klic” connector, can be connected with the mask at any angle, easy to use and with red screw to adjust the additional flow



气瓶 Cylinder

- 新型的活动气瓶托架，坚固耐用，装卸方便快捷
- 瓶阀上面带双面荧光可视压力表，方便检查气瓶余气
- 可选购特有的止逆阀保证一旦打开瓶阀后不会因为误操作而切断供气
- Durable cylinder bracket, easy to install or unpick the cylinder
- Double cylinder valves with nightlight function, easy to check the pressure at any time
- Optional locking handwheel prevent the cylinder valve from being closed accidentally



工业/消防用呼吸器, PANTHER

为了充分保护消防人员的生命安全, 美国对于呼吸器产品的认证有着严格的分工;

- NIOSH (美国职业安全健康中心) 仅负责工业用呼吸器相关标准的制定, 且严禁将工业用呼吸器产品用于消防战斗
- NFPA (美国消防协会) 负责消防行业呼吸器产品相关标准的制定, 对呼吸器各方面的性能都提出了更高的要求

In order to ensure the safety of different end users, the USA have 2 kinds of organizations to set up the standards

- NIOSH: responsible for setting up product standards for industry only
- NFPA: responsible for setting up product standards for fire-fighting only

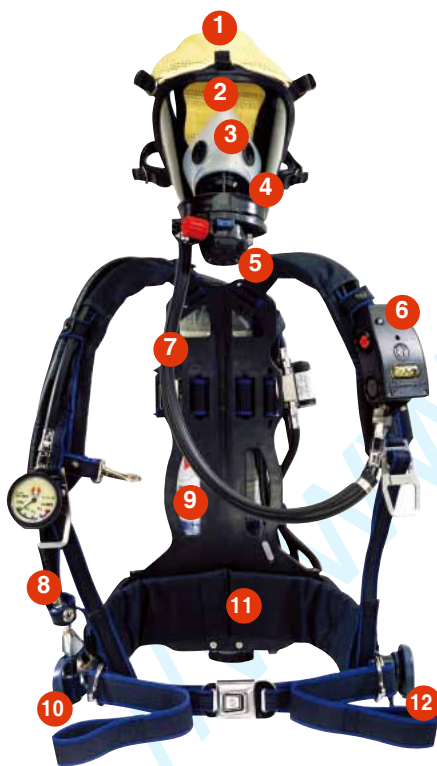

- 1 “Kevlar 头网” 面罩, 同时有硅树脂材料头带产品供选择
Kevlar Headnet, also available with silicone head strap
- 2 “Twenty twenty” plus 硅树脂面屏三种尺寸供选择
Twenty Twenty plus Silicone facepiece available in three sizes
- 3 口鼻罩, 三种尺寸供选择
Nose cup available in three sizes
- 4 “HUD (抬头显示)” 持续的压力读数, 3种低气量报警模式
Head-Up Display with continuous pressure reading and 3 low air alarms
- 5 二级调节器, 与面罩轻松连接
Second stage regulator attaches to and detaches from facepiece quickly and easily
- 6 可选择的“COMPASS” 位移报警装置
Optional COMPASS integrated PASS device
- 7 硅树脂护套保护充气管路和电路系统
Silicone extrusion protects pneumatic hose and electronic cable
- 8 可选择的压力表
Optional analog pressure gauge
- 9 手提手柄
Carrying handles for easy transportation
- 10 可选择的三重装置, (他救接口) 供同伴呼吸使用
Optional dual fitting that allows buddy breathing without regulator disconnection
- 11 HIGH PAD 衬垫给使用者 大的舒适感
Hip pad for maximum comfort
- 12 “二级调节器”座
Regulator holder to store regulator in standby mode

经 NFPA 认证的领先科技 Key features of NFPA

HUD电子压力显示及报警系统; SURVIVIAIR Panther呼吸器让我们开始在面罩里看压力!!!

HUD system: Head Up Display system, the second electronic pressure display system allows the user to see the pressure of its cylinder in the mask



位移报警系统 COMPASS system

让救援人员知道自己受伤的同伴在哪里

Let the rescuing persons know where the injured and the unconscious are



Small talk扩音系统 Small talk

Amplifying system with loudspeaker



RCS通讯系统 RCS system

简单结构的通讯系统, 提供 良好的通讯效果

Communication system with simplest parts and best communication quality, in the market, thus letting people communicate in fire fighting



RIT KIT

RIT KIT救援包可提供复杂危险环境的快速解决方案。因为它是手提式的所以也可用于密闭空间的救援

The RIT Kit was designed to offer rapid intervention teams a comprehensive, well-organized rescue package to address most circumstances they might encounter. Due to its portability, the RIT Kit also works well for confined-space rescue

逃生系统

Escape Devices



订货号 Ref.:7902



订货号 Ref.:7904



7902/7904 紧急逃生呼吸器，过滤式

符合美国NIOSH标准

- 简单经济，可用于非IDLH环境中紧急逃生
- 符合NIOSH标准。适用于公共事业/救援组/办公大楼/工厂/医院/住宅/宾馆/仓库/化工厂等场合使用
- 7902可用于从含氯、氯化氢、硫化氢、二氧化氯、二氧化硫、氟化氢的空气中逃生
- 7904用于氨气逃生
- The Emergency mouthpiece respirator is an air-purifying respirator ideal for escape from environments that are not immediately dangerous to life or health (IDLH).
- Approved by NIOSH as an Emergency Escape Respirator to be used in utilities/rescue team/building/factory/hospital/appartment/hotels/chemicals.
- 7902 is for Acid-Gases(Chlorine, Hydrogen Chloride, Sulfur Dioxide, Hydrogen Sulfide, Hydrogen Fluoride and Chlorine Dioxide).
- 7904 is used for ammonia escape

型号 Ref.	说明 Description
7902	紧急逃生口鼻式呼吸器，可用于从含氯、氯化氢、硫化氢、二氧化氯、二氧化硫的大气中逃生。 Emergency Escape Respirator to be used in Chlorine, Hydrogen Chloride, Sulfur Dioxide, Hydrogen Sulfide, Hydrogen Fluoride and Chlorine Dioxide
7904	紧急逃生口鼻式呼吸器，氨气防护 Emergency Escape Respirator to be used in ammonia

逃生半面罩在危险出现时及时提供防护

Half-face evacuation mask for immediate protection in case of danger



订货号: 17 285 00 (Half mask)
Ref. 17 285 55(可替换滤盒) (Filter)

Evamasque系紧急逃生呼吸器，过滤式

符合欧洲EN标准 EN Standard

- 逃生式半面罩
- 配有ABEK1过滤罐
- 配有独立包装外盒存放安全卫生
- 专配与腰带连接的搭扣
- 可与护目镜配合使用
- Half-face escape mask
- Built-in ABEK1 filter
- Hygienically stored in its own container
- Hook for adjustment to a belt
- Can be worn with goggles

ER 2000 灾难预防和紧急逃生头罩，过滤式

- ER2000 灾难预防及紧急逃生头罩是专为逃生用途设计的，可用于从非立即危害生命及健康的有机气体/蒸汽，无机气体/蒸汽，二氧化硫，氨气，一氧化碳，粉尘中逃生
- 符合EN141/EN14387/EN403及消防EN403 M 级标准，适用于公共事业/救援组/办公大楼/工厂/医院/住宅/宾馆/仓库/化工厂
- 由头罩、颈部密封圈、口鼻罩和一个紧固在头罩上的滤罐（规格：ABEKOP3）组成。保护头部，眼部和呼吸器官不受火灾气体，燃烧异味，二氧化碳或其他气体的侵害
- 仅限一次性或短时间使用，不适合12岁以下的儿童使用
- The ER2000 Escape hood is fully assembled for escape only, protecting against non-IDLH atmospheres containing industrial gasses, vapours, carbon monoxide and toxic particles.
- Conforms to EN141/EN14387/EN403 and EN403 Class M (portable escape hood) to be used in utilities/rescue team/building/factory/hospital/appartment/hotels/chemicals.
- Consisting of a hood with a neck seal, an oral / nasal cup, and an air-purifying filter cartridge ABEKOP3 to protect user's head, eyes and breathing from fire gases, burning odors, CO₂ and other gases.
- This respirator is for single use only, and not suitable for children younger than 12 years old.



订货号 Ref.: A168180



订货号 Ref.	标准 Standard	头罩 Hood	面屏 Visor	口鼻罩 Nose cup	护颈 Neck seal	滤罐 Canister	设计 Design
A168180	EN141 EN14387 EN403	聚氨酯材料， 1.5mm厚，经久 耐用 PU-1.5mm thick- ness	聚氨酯制面屏， 防雾功能。3mm厚 25cm x 11cm PU visor, anti-foggy, 3mm thickness, 25cmx11cm	内置口鼻 罩杯 Inner oral/ nasal cup	丁基合成橡胶， 2mm厚，弹性密封 Butyl 2.2mm thickness, elastic seal	ABEKOP3 (可选NBC) ABEKOP3 (NBC for selection)	外置式头带， 反光设计 Outside head strap, Reflec- tive stripe



订货号 Ref.: BC11 820 11

Evapack 逃生呼吸器/消防指挥员呼吸器，供气式 Evapack Escaping SCBA

- 恒流式逃生空气呼吸器，带有1个2升300巴带压力表气瓶，可使用约15分钟
- 1 cylinder with cylinder valve, 2 liters capacity with 300 bar pressure. It can be used for 15 minutes, small standard SCBA with cylinder gauge and demand valve



订货号 Ref.: BC11 820 21

Auto Pack 逃生呼吸器，供气式 Auto Pack Escaping SCBA

- 恒流式逃生空气呼吸器，带有1个2升300巴带压力表气瓶，可使用约15分钟
- 1 cylinder with cylinder valve, 2 liters capacity with 300 bar pressure. It can be used for 15 minutes, the hood can protect the whole head



845/850紧急逃生呼吸器，供气式

- 满足紧急逃生途中的呼吸需求。有5分钟及10分钟两种产品可供选择
- 符合NIOSH标准。适用于公共事业/救援组/办公大楼/工厂/医院/住宅/宾馆/仓库/化工厂等场合使用
- 透明面罩，保持逃生过程中的最佳视野。气流由额前进入面罩，防止面罩产生雾气
- 外侧指示计，方便用户了解呼吸器是否可以开始使用
- 铝制气瓶，通过静水压测试，可使用5年
- Supplying a continuous flow of 5 or 10 minutes of air, allowing workers to safely exit from a contaminated area.
- Conforms to NIOSH standards.
- Transparent polyurethane hood is safer, no blind spots to obstruct vision. Rescue personnel have full view of worker.
- Air deflector directs air to front of hood, eliminating any possible fogging.
- Gauge not hidden inside bag. Easy access to assure the EEBA is always filled and ready for use.
- Aluminum Cylinder. 5 year hydrostatic test versus 3 years for composite cylinders.

订货号 Ref.	说明 Description
845	5分钟紧急逃生呼吸器，平均每分钟42升 5 Minute EEBA, 42L/min
850	10分钟紧急逃生呼吸器，平均每分钟42升 10 Minute EEBA, 42L/min

高压气瓶充气泵 Compressor

高压充气压缩机系列

HSP现有专业的空气呼吸器充气设备提供。更详细的资料，请向我们的销售人员或拨打服务热线索取。



Junior /Oceanus SERIES



Captano/Mariner SERIES



Mini Verticus 5 SERIES



V5/KAP 5 SERIES

订货号	充气量	动力	尺寸			净重 (约)
			长	宽	高	公斤
JII-E-H	100	三相	660	360	420	44
O-E-H	140	三相	660	400	420	52
C 140-E-H	140	三相	1150	590	550	102
M 200-E-H	200	三相	1250	590	630	115
M 250-E-H	250	三相	1250	590	630	135
M 320-E-H	320	三相	1300	645	700	154
MV 120-5,5-3	250	三相	1020	740	1300	255
V15.1-7.5-5	370	三相	1480	830	1520	430
V15.1-11-5	450	三相	1480	830	1520	440
V150-11-5	540	三相	1480	830	1520	440
V180-15-5	680	三相	1480	830	1520	455
KAP 15.1-7.5-5	370	三相	1140	830	1520	340
KAP 15.1-11-5	450	三相	1140	830	1520	350
KAP 150-11-5	540	三相	1140	830	1520	350
KAP 180-15-5	680	三相	1140	830	1520	365

Compressor

Professional SCBA refilling devices are also available in HSP. For detailed information, please contact your sales or dial our hotline for help.



Junior /Oceanus SERIES



Captano/Mariner SERIES



Mini Verticus 5 SERIES



V5/KAP 5 SERIES

订货号	FAD L/Min	DRIVE	DIMENSION (mm)			NET WEIGHT
			L	W	H	Kg
JII-E-H	100	三相	660	360	420	44
O-E-H	140	三相	660	400	420	52
C 140-E-H	140	三相	1150	590	550	102
M 200-E-H	200	三相	1250	590	630	115
M 250-E-H	250	三相	1250	590	630	135
M 320-E-H	320	三相	1300	645	700	154
MV 120-5,5-3	250	三相	1020	740	1300	255
V15.1-7.5-5	370	三相	1480	830	1520	430
V15.1-11-5	450	三相	1480	830	1520	440
V150-11-5	540	三相	1480	830	1520	440
V180-15-5	680	三相	1480	830	1520	455
KAP 15.1-7.5-5	370	三相	1140	830	1520	340
KAP 15.1-11-5	450	三相	1140	830	1520	350
KAP 150-11-5	540	三相	1140	830	1520	350
KAP 180-15-5	680	三相	1140	830	1520	365



单一气体检测仪	Single-Sensor Gas Monitors	73
多气体检测仪	Multi-Sensor Gas Monitors	75
固定式系统	Fixed systems	79
空气过滤系统	Air filtration System	80
SCBA呼吸器检测仪	SCBA Perfotmance Testers	81
IQ Express™全自动检测标定仪	IQ Express™ Docking Station	82



很多情况下，人们需要在储油罐、船舱、锅炉、下水道、隧道、输送管道、陷阱、地窖、水容器、船货仓等密闭空间进行焊接、喷漆、维修等工作，这类场合由于并非为人们长期工作所设计，出入口空间比较有限，非常容易存在中三种基本危害：

- 缺乏氧气或氧气过多，当氧气含量为
 - 19.5% - 12%时，人将出现判断力降低，呼吸及脉搏加速，疲乏，各器官协调能力丧失，
 - 12% - 10%时，人将处于该环境下几秒至几分钟，便会出现呼吸作用失常，身体循环能力减弱，更加疲乏，辨别能力丧失 等症状
 - 10% - 6%时，人将出现恶心，呕吐，行动困难，失去意识，死亡
 - 6% - 0%时，将出现抽搐，呼吸作用衰竭，呼吸停止，心跳停止，以上症状会立即显现，几分钟内死亡
- 有潜在的有毒污染物如CO、H₂S

CO 是美国中毒事故中的首要诱因！CO 所引起中毒事故的机会远胜于其他任何化学物质，即使是在极低的浓度下慢性接触也是有害的。65%的密闭空间死亡事故是由有害气体造成的，
- 有可燃性气体或蒸汽（LEL）

因此，进入密闭空间前，确认其中的气体安全是非常重要的，同时还需要通风保障气体安全。

气体检测仪能够提供密闭空间内各类气体实时的浓度读数，并在读数到达危险阈值时发出声光报警，确保操作人员的安全。



公司质量体系通过
ISO9001:2000认证



欧洲质量认证



美国UL认证



DEMKO
国际认证

单一气体检测仪

Single-Sensor Gas Monitors



ToxiLtd® 单一气体检测仪

ToxiLtd® Single-Sensor Gas Monitor

- 两年使用期限型单一气体探测仪
- 设计小巧, 结实耐用, 一键式操作
- 顶端前置LCD灯
- 连续实时显示气体读数
- 可选振动报警
- 自动时间记录器
- 与IQ Express™可与单一气检测仪全自动检测标定仪相兼容
- Two-year disposable single gas detector
- Compact and rugged design with one-button operation
- Top and front-mounted bright LED
- Continuous real-time gas readings
- Optional vibrating alarm
- Automatic event logger
- Compatible with the IQ Express™ Single Gas Docking Station

订货号 Ref.	描述 Description
54-44-01	一氧化碳 Carbon Monoxide
54-44-02	硫化氢 Hydrogen Sulfide

套件和振动报警可选购; 配件也可选购。

Value pack and vibrating alarm options available; accessories also available.



ToxiPro® 单一气体检测仪

ToxiPro® Single-Sensor Gas Monitor

- 设计小巧, 结实耐用, 一键式操作
- 可选传感器种类: O₂, CO, H₂S, SO₂, Cl₂, ClO₂, NH₃, NO₂, PH₃, HCN, CO-H
- 嵌有三个高亮度黄色和红色LED警报灯
- 连续实时显示气体读数
- 黑匣子数据记录器和事件记录器标准配置
- 可选购振动报警, 数据记录下载功能和外箱
- 可与 IQ Express™ 单一气体全自动检测标定仪相兼容
- Compact and rugged design with one-button operation
- Available sensors: O₂, CO, H₂S, SO₂, Cl₂, ClO₂, NH₃, NO₂, PH₃, HCN, CO-H
- Three highly visible yellow and red alarm LEDs that chase
- Continuous real-time gas readings
- Blackbox data recorder and event logger standard
- Optional vibrating alarm, datalogging, and case
- Compatible with the IQ Express™ Single-Gas Docking Station

订货号 Ref.	描述 Description
54-45-90	氧气 Oxygen
54-45-01	一氧化碳 Carbon Monoxide
54-45-02	硫化氢 Hydrogen Sulfide

增值套件和震动报警数据下载功能可选购; 传感器替换件和配件也可选购。

Value pack, vibrating alarm and data logging options available; replacement sensors and accessories also available.

- 1 正常 NORMAL
2 警报 WARNING CONDITION



- 3 危险情况 DANGER CONDITION

Sperian生产的ToxiPro®设有三个可视警报窗口以确保使用者的安全。每一个警报窗口标准配备有两个高亮度的黄色和红色警报LED灯。此外ToxiPro®的声音报警, 响度比之前的型号高出10%。

ToxiPro® by Sperian has three visual alarm windows for increased worker safety. Each alarm window comes standard with both high visibility yellow and red alarm LEDs. Plus, the ToxiPro® has an audible alarm that is 10% louder than previous models!



IQ Express™ 全自动检测标测定仪

IQ Express™ Docking Station

- 为ToxiPro®和Toxi Ltd®单一气体检测器配置的全自动撞击测试和全自动检测标测定仪
- 自动识别检测仪，测试报警和电池并下载记录
- 如需要，自动标定
- 每种气体可同时连接四个全自动检测标测定仪
- 可通过USB或以太网连接电脑（可订购）
- 所需流量阀，标准气体和ToxiPro、ToxiLtd单独出售
- A fully automated bump test and calibration station for the ToxiPro® and ToxiLtd® single gas detectors
- Automatically identifies detector, tests alarms and battery, and downloads records
- Automatic detector calibration, if necessary
- Link up to four docks to a single gas supply
- Connects to PC via USB port or Ethernet (optional)
- Demand flow regulators, calibration gas and ToxiPro and ToxiLtd each sold eparately

订货号 Ref.	描述 Description
54-46-9000	IQ Express配置配件，适用O ₂ ,CO,SO ₂ 或H ₂ S气体 IQ Express with Accessories for O ₂ , CO, SO ₂ , or H ₂ S Instruments
54-46-9100N	以太网加强版IQ Express适用O ₂ ,CO,SO ₂ Cl ₂ ,NO ₂ ,NH ₃ ,HCN, 或PH ₃ Ethernet-Ready Enhanced IQ Express for O ₂ , CO, H ₂ S, SO ₂ , Cl ₂ , NO ₂ , NH ₃ , HCN, or PH ₃ Instruments

多种气体检测仪 Multi-Sensor Gas Monitors

PHD6™ 密闭空间多气体检测仪 PHD6™ Confined Space Gas Monitor



- 最多同时能检测空气中6种危险其他
- 传感器包含氧气，可燃性气体，挥发性有机化合物蒸汽和多种有毒有害气体
- 挥发性有机化合物蒸汽VOC检测，可选择光离子（PID）原理传感器
- CO₂或CH₄检测，可选用红外原理IR传感器
- 黑匣子数据记录器和数据下载功能（选件）可提供连续大气状况检测记录数据
- 可选安装式有泄露和低流量报警功能的自动采样泵
- IQ6™全自动检测标定仪系统
- Monitors up to six atmospheric hazards simultaneously
- Sensors available for oxygen, combustible gas, volatile organic compounds, and several different toxic gases
- Optional Photo Ionization (PID) sensor available for the detection of VOCs
- Optional IR sensors available for the detection of CO₂ or CH₄
- Built-in blackbox data recorder and datalogging option provides a record of atmospheric conditions during operation
- Optional screw-on pump with automatic leak test and low flow alarm
- Compatible with the IQ6™ Docking System

订货号 Ref.	描述 Description
54-53-A14008000AV	O ₂ /Duo-Tox (CO/H ₂ S)/LEL 碱性电池C 套装 O ₂ /Duo-Tox (CO/H ₂ S)/LEL Alkaline Value Pack
54-53-A01025280N	O ₂ /CO/H ₂ S/LEL/PID 可充电式电池 O ₂ /CO/H ₂ S/LEL/PID Rechargeable
54-53-A01025080N	O ₂ /CO/H ₂ S/LEL/IR-CO ₂ 可充电式电池 O ₂ /CO/H ₂ S/LEL/IR-CO ₂ Rechargeable
54-53-A14005100NC	O ₂ /Duo-Tox (CO/H ₂ S)/IR-CH ₄ 可充电式电池完整套装 O ₂ /Duo-Tox (CO/H ₂ S)/IR-CH ₄ Rechargeable Complete Kit

IQ6™ 全自动检测标测定仪

IQ6™ Docking Station



- 最多同时能检测空气中6种危险其他
- 全自动撞击测试和标定全自动检测标测定仪，适用于PHD6™气体检测仪
- 自动识别仪器，测试报警、电池，下载记录数据
- 自动仪器撞击测试，标定检查，如有需要进行全面标定
- 通过USB端口或以太网连接电脑
- 放置在全自动检测标测定仪槽中，可对仪器进行充电（仅限于可充电式PHD6）
- 所需流量调节阀，校准气体和PHD6单独出售
- A fully automated bump test and calibration station for the PHD6™ gas monitor
- Automatically identifies instrument, tests alarms/battery, downloads records
- Automatic instrument bump test, calibration check and full calibration, if necessary
- Connects to PC via USB port or Ethernet
- Recharges instrument if left in dock (rechargeable PHD6 only)
- Demand flow regulators, calibration gas and PHD6 sold separately

订货号 Ref.	描述 Description
54-54-9200	IQ6 全自动检测标测定仪，带软件，安装光盘和用户手册 IQ6 Dock w/Software, Installation Disks and Manual
54-54-9200N	IQ6 全自动检测标测定仪，带以太网接口 Ethernet-Ready IQ6 Dock

Cannonball3™ 多气体检测仪

Cannonball3™ Multi-Sensor Gas Monitor



- 可选购高灵敏度可燃性气体传感器，可以检测及显示PPM级可燃性气体和蒸汽
- 可选购专利稀释泵，正确监控氧气稀缺环境（少于10%）或是无氧（纯惰性）环境下的可燃性气体和蒸汽浓度
- 防刮C大显示屏，易于读取数据
- C大的控制按钮和导航键，专为佩戴手套时使用设计
- 三个明亮的报警灯，确保至少其中一个的LED灯一直可见
- 可选购振动报警，数据下载功能和外箱
- 可与IQ Express™ 单一气体全自动检测标测定仪相兼容
- Available with optional, high-sensitivity combustible gas sensor capable of displaying trace PPM-level combustible gases and vapors
- Optional patented dilution pump for proper monitoring of combustible gases and vapors in oxygen deficient (less than 10%) or oxygen-free (fully inerted) environments
- Scratch-resistant, oversized display for easy reading
- Large control buttons and navigation arrows are designed for use with a gloved hand
- Three bright visual alarms ensure that at least one of the LEDs can be viewed at all times
- Optional vibrating alarm, datalogging, and case
- Compatible with the IQ Express™ Single-Gas Docking Station

订货号 Ref.	描述 Description
54-34-30102N	O2/CO/H2S/LEL可充电式 O2/CO/H2S/LEL Rechargeable
54-35-30102N	O2/CO/H2S/LEL可充电式并配备稀释泵 O2/CO/H2S/LEL Rechargeable with Dilution Pump

MultiPro™ 密闭空间多气体检测仪 MultiPro™ Confined Space Gas Monitor



- 实时检测机显示四种气体的实测数据
- 一键式操作和标定
- 宽大易读取数据，前置背光的LED显示屏
- 可选螺丝安装采样泵，自动进行泄露测试和低流量报警
- 自动事件记录器，黑匣子记录器和可选购数据下载功能
- 可选碱性电池或充电式锂电池组
- Real-time readings of up to four gases simultaneously
- Easy one-button operation and calibration
- Large, easy-to-read, front-mounted, backlit LCD display
- Optional screw-on pump with automatic leak test and low flow alarm
- Automatic event logger, blackbox recorder and optional datalogging
- Interchangeable alkaline or rechargeable Li-Ion battery packs
- Compatible with MultiPro™ IQ Express™ Docking Station

订货号 Ref.	描述 Description
54-48-301A	O ₂ /CO/LEL 碱性电池 O ₂ /CO/LEL Alkaline
54-48-302N	O ₂ /CO/LEL 可充电式电池 O ₂ /H ₂ S/LEL Rechargeable
54-48-314AV	O ₂ /Duo-Tox (CO/H ₂ S)/LEL 碱性电池C 包装 O ₂ /Duo-Tox (CO/H ₂ S)/LEL Alkaline Value Pack
54-48-314NC	O ₂ /Duo-Tox (CO/H ₂ S)/LEL 可充电式电池完整包装 O ₂ /Duo-Tox (CO/H ₂ S)/LEL Rechargeable Complete Kit

MultiPro™ IQ Express™ 全自动检测标定仪 MultiPro™ IQ Express™ Docking Station



- 全自动撞击测试和全自动检测标定仪，适用于 MultiPro 气体检测仪
- 自动识别仪器，检测报警功能和电池电压，下载记录数据
- 自动撞击测试，标定检查，如需要进行全面标定
- 通过USB端口或以太网连接至电脑（可选购）
- 所需气体节流阀，标准气体和MultiPro检测仪需分别购买与全自动检测标定仪兼容
- Fully automated bump test and calibration station for the MultiPro gas detector
- Automatically identifies instrument, tests alarms and battery, and downloads records
- Automatic instrument bump test, calibration check and full calibration, if necessary
- Connects to PC via USB port or Ethernet (optional)
- Demand flow regulators, calibration gas and MultiPro

订货号 Ref.	描述 Description
54-49-9000	MultiPro IQ Express 全自动检测标定仪/软件，安装盘，操作手册 MultiPro IQ Express Dock w/Software, Installation Disks, Manual
54-49-9000N	配置以太网的 MultiPro IQ Express 全自动检测标定仪 Ethernet-Ready MultiPro IQ Express Dock

Multi Vision™ 多气体检测仪

Multi Vision™ Multi-Sensor Gas Monitor



- 便利的一键式操作和自动校准
- 结实耐用，耐风雨，镀铬ABC盖
- 可选购内置泵
- 体功能限定空间包和C 套装
- Easy one-button operation and automatic calibration
- Rugged and weatherproof chrome-plated ABS case
- Optional built-in pump
- Confined space kit and value pack available

订货号 Ref.	描述 Description
54-40-30100A	O ₂ /CO/LEL 碱性电池 O ₂ /CO/LEL Alkaline
54-40-30200N	O ₂ /CO/LEL 可充电式电池 O ₂ /H ₂ S/LEL Rechargeable
54-40-30102AV	O ₂ /CO/H ₂ S/LEL 碱性电池C 套装 O ₂ /CO/H ₂ S/LEL Alkaline Value Pack
54-40-30102NC	O ₂ /CO/H ₂ S/LEL 可充式电池完整包装 O ₂ /CO/H ₂ S/LEL Rechargeable Complete Kit

固定式系统 Fixed Systems

适用于无爆炸环境和潜在爆炸环境的NXP™和EXP™是安全可靠地固定式气体检测系统，既节约成本又易于安装。他们提供了一系列全面选择和标准功能。拥有NXP或EXP，让您在工作中享受安心和放松。

The NXP™ for nonhazardous environments and EXP™ for potentially explosive environments are safe and reliable fixed placement gas detection systems that are both cost effective and ultra-easy to install. They offer a full range of installation options and incredible standard features. You can relax with the NXP or EXP on the job.

NXP™固定式气体检测仪 NXP™ Fixed Gas Monitor



- 配有双色高强度频闪灯
- 配备105分贝报警
- 三个用户可自编程板载继电器：警告，危险和故障
- 板载事件记录器，能记录纸上128条事件
- IP66防护等级，NEMA 4X外壳，在恶劣环境下及水洗状态下保护内部组件
- 可以单独安装监控，远程探头和单点控制主机或是变送器输出连接大型系统
- Plugs into standard wall outlet for easy installation
- Integrated twin color high-intensity strobes
- Integrated 105dB Audio Alarm
- Three user-available programmable onboard relays: Warning, Danger and Fault
- On-board event logger records last 128 events
- Tough IP66, NEMA 4X housing protects unit in harsh conditions or during wash-downs
- Unit can be a stand-alone monitor, a remote sensing head and single point control unit or as a transmitter in a larger system

订货号 Ref.	描述 Description
54-55-010	一氧化碳 Carbon Monoxide
54-55-020	硫化氢 Hydrogen Sulfide
54-55-190	抗氢干扰的一氧化碳探头 Carbon Monoxide with Reduced Hydrogen Sensitivity
54-55-900	氧气 Oxygen

EXP™固定式气体检测仪 EXP™ Fixed Gas Monitor



- 插到标安装配件中就能方便安装
- 配备双色高强度频闪灯
- 三个用户可编程板载继电器：警告，危险和故障
- 板载事件记录器，能记录至少128条事件
- 报警点和传感器范围可调
- 坚固的浇注铝防爆外壳，恶劣环境下及水洗状态下保护内部组织
- 可以独立监控，远程探头和单点控制主机或是变送器输出连接大型系统
- Plugs into standard wall outlet for easy installation
- Integrated twin color high-intensity LED lights
- Three user-available programmable on-board relays: Warning, Danger and Fault
- On-board event logger records last 128 events
- Adjustable alarm levels and sensor ranges
- Tough cast aluminum, explosion-proof housing protects unit in harsh conditions or during wash-downs
- Unit can be used as a stand-alone monitor, a remote sensing head and single point control unit, or as a transmitter in a larger system

订货号 Ref.	描述 Description
54-62-010	一氧化碳 CO, Carbon Monoxide
54-62-020	硫化氢 H2S, Hydrogen Sulfide
54-62-800	可燃性气体 LEL, Combustible Gas
54-62-190	CO-H, (CO: 抗氢干扰) CO-H, (CO: reduced sensitivity to H ₂)
54-62-900	氧气 Oxygen

空气过滤系统 Air Filtration System

TravelPanel™ 50MP 在市场中建立了便利使用便携式空气过滤器的里程碑。过滤器滤芯更换可在一分钟内完成。锁定稳固支架能保持仪器直立。内置**MultPro™**气体检测仪标定可在一分钟内完成。

The TravelPanel™ 50MP sets the benchmark for ease of use in the portable air filtration market.

Filter changes can be made in just a few minutes. Locking stabilizer legs keep it upright.

Calibration of the built-in MultiPro™ gas monitor can be made in under a minute.

TravelPanel™ 50MP 便携式空气过滤系统



- 为最多四名适用空气呼吸器的使用者供应D级呼吸用空气
- 供应50CFM（立方英尺每分钟）的净化空气
- 三级过滤系统，去除颗粒、液体、油雾和气味。装备滤芯更换报警指示灯
- 提供镍氢可充电电池或碱性电池，两者均可运行大于100小时
- 坚固的Pelican™外箱，可选稳固支架
- 内置MultiPro™气体检测仪自动检测CO（一氧化碳）污染
- 可选墙壁托架
- Designed to deliver Grade-D breathing air for up to four workers using supplied air respirators
- Can supply 50 CFM (cubic feet per minute) of purified air
- Three stage filtration system removes particulates, liquids, oil mists and odors. Includes automatic filter change indicator
- Available with NiMH rechargeable or alkaline battery, both with run times as long as 100 hours
- Rugged Pelican™ case with optional stabilizer legs
- Built-in MultiPro™ gas detector automatically monitors outlet air for CO (carbon monoxide) contamination
- Optional wall mounting bracket available

订货号 Ref.	描述 Description
CO/O₂传感器 CO/O₂Sensors	
54-50-331NH0	LED频闪灯，锁定稳固支架，低压警报，可充电式电池和Hansen快速接头 LED Strobe Light, Locking Stabilizer Legs, Low Pressure Alarm, Rechargeable Battery, and Hansen Outlet Fittings
54-50-300NH1	无额外的报警选项，可充电式电池，Hansen快速接头，MultiPro数据记录下载功能，黄色外箱 No Additional Alarm Options, Rechargeable Battery, Hansen Outlet Fittings, MultiPro Data logger Upgrade, Yellow Case
54-50-331NH3B	LED频闪灯，锁定稳固支架，低压警报，可充电式电池和Hansen快速接头，MultiPro数据记录下载功能，黑色外箱 LED Strobe Light, Locking Stabilizer Bars, Low Pressure Alarm Option, Rechargeable Battery, Hansen Outlet Fittings, MultiPro Data logger Upgrade and Dustcovers, Black Case
只限CO传感器 CO Sensor Only	
54-50-100NS0	无额外的报警选项，可充电式电池，Schrader快速接头，无二次选择，黄色外箱 No Additional Alarm Options, Rechargeable Battery, Schrader Outlet Fittings, No Secondary Options, Yellow Case

SCBA呼吸器检测仪

SCBA Performance Testers

工业领域内领先的符合NFPA认证标准呼吸器检测系统！

Posi 3 USB™广泛应用于消防部队，炼油厂、化工厂、核电站及工业领域，立刻确定您的呼吸器是否正常使用。

The Posi 3 USB™ is the industry's leading NFPA Compliant SCBA Test Bench.

Fire Departments, refineries, chemical plants, and nuclear power stations rely on the Posi 3 USB™ to verify that their SCBAs are fit for use.

Posi 3 USB™ SCBA呼吸器检测仪

Posi 3 USB™ SCBA Performance Testers



- USB通讯
- SCBA电脑测试台，测试几乎所有品牌的SCBA性能
- 测试低压（2216 psig）和高压（4500 psig）单元
- 可选声音监测系统（SDS），全自动声音检测报警
- 快速测试，在2分钟内测评SCBA的工作稳定性
- USB communication capability
- Computerized test bench, tests performance of virtually any brand SCBA
- Tests Low Pressure (2216 psig) and High Pressure (4500 psig) units
- Optional Sound Detection System (SDS) automates the primary audible alarm test
- Quick Test evaluates the operational readiness of a SCBA in less than 2 minutes

订货号 Ref.	描述 Description
54-56-1117	中级转换器在低压（2216 psig）和高压（4500 psig）测试减压阀，包括精度提升（EP）转换器和Posi 3 USB SCBA测试软件 Low and High Pressure (2216 and 4500 psig) with Middle Stage Transducer, Including Enhanced Precision (EP) Transducer and Posi 3 USB SCBA Test Software
54-56-1117-L	配置便携式电脑的Posi 3 USB（EP） Posi 3 USB (EP) with Laptop Computer Package
54-56-2117	中级转换器在低压（2216 psig）和高压（4500 psig）测试减压阀，包括精度提升（EP）转换器，声音检测系统（SDS）和Posi 3 USB SCBA测试软件 Low and High Pressure (2216 and 4500 psig) with Middle Stage Transducer, Including Enhanced Precision (EP) Transducer, Sound Detection System (SDS) and Posi 3 USB SCBA Test Software
54-56-2117-L	配置便携式电脑的Posi 3 USB（EP和SDS） Posi 3 USB (EP and SDS) with Laptop Computer Package
升级您的PosiChek3® Upgrade Your Existing PosiChek3®	
54-21-09	升级Posi 3至Posi 3 USB Upgrade a PosiChek3 to a Posi 3 USB
54-21-10	升级配置有声音检测系统的Posi 3至 Posi 3 USB Upgrade a PosiChek3 with Sound Detection System to a Posi 3 USB

IQ Express™全自动检测标测定仪

IQ Express™ Docking Station

全自动检测标测定仪：有效气体检测程序中 重要的部分

我们坚信斯博瑞安设计生产市场上 好的全自动检测标测定仪。它具有极强的处理能力和灵活性， 易操作。使用只需要将使用完毕检测仪器放置在全自动检测标测定仪上，它会自动处理和记录所有。



1. 降低标定气体使用成本

比于手动标定，Sperian全自动检测标测定仪使用的气体大大减少。例如：如果您拥有10个MultiPro™气体检测仪，并且遵循ISEA推荐的指南每天在使用前进行撞击测试和校准检查，您可能每年付出气体成本高达10,000美元。如果使用对接器，您能将气体成本减少60%以上。因此，IQ Express™全自动检测标测定仪每年能为您节省至少6,000美元的气体成本费用。

2. 通过减少检测，标定所花费的时间来降低劳动成本

每次为一个仪器进行手动测试平均要花约2分钟的时间。IQ Express™全自动检测标测定仪只需约22秒就能完成一次测试。如果每天早晨，您需要为10个仪器进行测试，一年您就可以节省约60个小时的劳动时间。

3. 通过纪录保持功能，全自动检测标测定仪降低劳动成本

事实上，记录保持需要大量的工作。每次下载一个个人仪器数据至电脑就要花几个小时的时间。手动追踪标定和记录花费的时间更多。使用IQ Express™全自动检测标测定仪，以上两个程序就能自动完成。

4. 全自动检测标测定仪减少法律责任

无论您的数据记录多么精准，手动系统还是会出现错误。如果发生事故，错误意味着法律责任。我们的全自动检测标测定仪能精准记录每次的测试数据。您的数据记录将会准确无误。

Docks: the most important part of an effective gas detection program

At Sperian Protection, we're convinced that we make the best docks on the market. Our docks offer incredible processing power and flexibility while being extremely easy to use. The worker just drops the detector in the dock at the beginning of his or her shift and the dock processes the instrument according to your recordkeeping protocols. It's that easy.

1. Docks reduce calibration gas expenses

Sperian's docks use a lot less gas than is used during manual calibrations. Here's an example: If you have 10 MultiPro™ gas detectors and follow the ISEA guideline that recommends a bump test or calibration check before use each day, you could spend over \$10,000 per year in gas costs. If you purchase a dock, you can reduce your gas costs by over 60%. So the IQ Express™ Dock could save you well over \$6,000 per year in gas costs alone.

2. Docks reduce labor expenses by cutting down on the time needed to perform a calibration

To set up and perform a manual bump test of a single instrument takes the average user about 2 minutes. A IQ Express™ Dock can perform a bump test in about 22 seconds. If you need to bump 10 instruments every morning, you could save over 60 hours of labor by the end of the first year.

3. Docks reduce labor expenses associated with recordkeeping

Let's face it: Recordkeeping is a lot of work. Downloading individual instrument records one at a time into a PC can take hours. Tracking calibration and exposure records by hand is even worse. In a IQ Express™ Dock, both of these procedures occur automatically during instrument processing.

4. Docks can reduce your legal liability

No matter how good your recordkeeping is, manual systems are prone to error. In case of an accident, errors mean liability. Our docks accurately record every test. Your recordkeeping is flawless.



脸部防护系列
e & Face Protection

呼吸防护系列
Respiratory Protection

气检测仪系列
Instrumentation

手部防护系列
Protective Gloves

防护服系列
Protective Clothing

足部防护系列
Foot Protection

坠落防护系列
Fall Protection

电力防护系列
Safety

消防救援防护
Safety



通用手套	General Handling	87
防割伤伤害	Cut Resistance	90
防化学类伤害	Chemical Resistance	93
抛弃型手套	Disposable	97
耐高温及焊接类应用	Heat Resistance and Welding Application	98
防冻伤害	Cold Resistance	102
受控环境	Controlled Environment	103

确定您的尺码

将手置于图中标示的位置，
 读出右侧的尺码标号。

Check your size

Place your hand on the
 diagram here to measure
 your hand size.

防护手套尺码对应表

Table of equivalence for gloves sizes

Perfect Fit					
6	7	8	9	10	11
Chainex(金属网手套)					
XS	S	M	L	XL	XXL
1	2	3	4	5	6

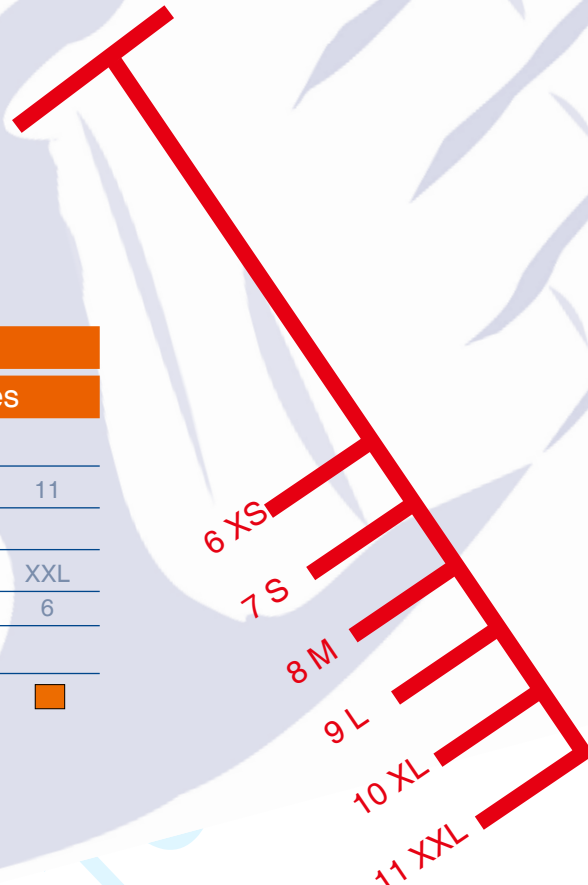

针织手套

在欧洲和美国，Honeywell是无可争议的针织手套业的领导者。其工厂拥有一千多台编织机，它的生产能力与革新能力使Honeywell成为追求高科技产品的公司的首选合作者。

裁剪手套

Honeywell的制造部门设计和生产一系列的裁剪手套，主要为由高质量皮革制成的手套。

浸胶手套

Honeywell出色地掌握整套浸涂技术：天然乳胶，合成橡胶（丁腈，氯丁橡胶，丁基橡胶），PVC，生产内衬式和无衬式手套。

受控环境手套

世界领先的手套箱手套制造商，包括丁基、氯丁橡胶、海帕隆®等多种材质，满足不同的防护需求。另有多种洁净室手套，适用于百级及以下洁净室环境。

危险和标准



EN388 机械性危险防护

- A 抗磨损
- B 防切割
- C 抗撕裂
- D 防穿刺



EN1082 冲击割伤防护

经过质量为1050克的金属刀片从250毫米高处落下的冲击切割试验



EN374/1-3 化学品防护

EN374-3表示该手套能在3种以上化学品中的耐渗透时间大于30分钟。



EN511 低温危险防护

- A 传导寒冷
- B 接触寒冷
- C 透水性-等级1至少防水30分钟



EN407 高温/火焰防护

- A 阻燃
- B 防接触热
- C 防对流热
- D 防辐射热
- E 防液态金属小颗粒，较少飞溅
- F 防液态金属小颗粒，较多喷射

化学物质与对应防护手套参照表

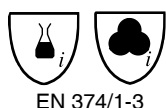

天然橡胶	氯丁二烯	腈	聚氯乙烯	天然橡胶	氯丁二烯	腈	聚氯乙烯	天然橡胶	天然橡胶	腈	聚氯乙烯
------	------	---	------	------	------	---	------	------	------	---	------

化学物质	天然橡胶	氯丁二烯	腈	聚氯乙烯	化学物质	天然橡胶	氯丁二烯	腈	聚氯乙烯	化学物质	天然橡胶	天然橡胶	腈	聚氯乙烯
乙醛	F	-	-	-	乙基苯氨	E	-	-	-	聚酯树脂	F	-	-	-
50%的醋酸酐	A	-	-	-	乙二醇	F	-	-	-	苛性钾片	B	-	-	-
丙酮	C	-	-	-	肥料	C	-	-	-	高浓度洗涤剂中的钾碱	B	-	-	-
氯丙酮	C	-	-	-	定象剂	E	-	-	-	乙酸钾	B	-	-	-
乙酸铵	B	-	-	-	氯化物	B	-	-	-	碳酸氢钾	A	-	-	-
碳酸铵	B	-	-	-	30%的甲醛	C	-	-	-	碳酸钾	B	-	-	-
氯化铵	B	-	-	-	90%的甲醛	B	-	-	-	氯化钾	B	-	-	-
硝酸铵	B	-	-	-	福莫尔 (或甲醛)	-	-	-	-	氰化钾	D	-	-	-
醋酸戊酯	A	-	-	-	香精	B	-	-	-	硝酸钾	B	-	-	-
戊基酸	C	-	-	-	燃料油	F	-	-	-	高锰酸钾	D	-	-	-
苯胺	E	-	-	-	燃料	E	-	-	-	磷酸钾	D	-	-	-
动物脂肪	-	-	-	-	吠喃甲醚(糖醛或糠醛)	F	-	-	-	硫酸钾	B	-	-	-
沥青	E	-	-	-	瓦斯油	F	-	-	-	二氯丙烷	F	-	-	-
苯醛	E	-	-	-	冰乙酸	B	-	-	-	生石灰	B	-	-	-
苯	E	-	-	-	甘油	-	-	-	-	硅酸盐	B	-	-	-
苯甲醇	E	-	-	-	甘油磷酸油漆	C	-	-	-	苏打片	B	-	-	-
漂白剂	B	-	-	-	糖醇	F	-	-	-	高浓度洗涤剂中的苏打	B	-	-	-
硼砂	A	-	-	-	除草剂	A	-	-	-	碳酸氢钠	A	-	-	-
制动器油 (洛克希德)	F	-	-	-	己烷	F	-	-	-	亚硫酸氢钠	A	-	-	-
溴酸	B	-	-	-	家用洗涤剂	A	-	-	-	碳酸钠	-	-	-	-
溴化物	C	-	-	-	液压力 (酯)	C	-	-	-	氯化钠	B	-	-	-
醋酸丁酯	C	-	-	-	液压力 (汽油)	F	-	-	-	次氯酸钠	B	-	-	-
丁醇 (或者n-丁醇)	D	-	-	-	30%的氢氟酸	B	-	-	-	硝酸钠	B	-	-	-
醋酸钙	-	-	-	-	次氯酸钠	B	-	-	-	磷酸钠	B	-	-	-
氯化钙	-	-	-	-	异丁醇 (或并丁醇)	A	-	-	-	硫酸钠	-	-	-	-
氟磷酸	B	-	-	-	异丁基醇	F	-	-	-	大豆油	B	-	-	-
氢氧化钙	-	-	-	-	煤油	F	-	-	-	硬脂酸	A	-	-	-
次氯酸钙	B	-	-	-	85%的乳酸	A	-	-	-	苯乙烯	A	-	-	-
硝酸钙	B	-	-	-	猪油	-	-	-	-	亚硫酸盐, 亚硫酸氢盐, 连二亚硫酸盐	B	-	-	-
磷酸钙	C	-	-	-	润滑油	F	-	-	-	硫乙醚(药房)	A	-	-	-
汽车汽油	E	-	-	-	氯化镁	-	-	-	-	焦油酸	A	-	-	-
石炭酸	D	-	-	-	甲基异丁基醇	F	-	-	-	四氢呋喃	B	-	-	-
四氯化碳	B	-	-	-	甲醇(或乙醇)	C	-	-	-	氯化锡	E	-	-	-
蓖麻油	B	-	-	-	乙酸甲酯	E	-	-	-	甲苯	A	-	-	-
氯酸	B	-	-	-	甲胺	E	-	-	-	磷酸丁酯	D	-	-	-
氯	B	-	-	-	甲基苯胺	E	-	-	-	三氯乙烯	F	-	-	-
三氯甲烷	F	-	-	-	甲基环戊烷	F	-	-	-	三硝基苯	E	-	-	-
30%和5%的盐酸	B	-	-	-	二氯甲烷	C	-	-	-	三硝基甲苯	E	-	-	-
枸橼酸	A	-	-	-	丁醇 (甲基乙基醇)	F	-	-	-	磷酸三苯酯	E	-	-	-
浓缩氨水	B	-	-	-	甲酸甲酯	F	-	-	-	松节油	E	-	-	-
浓缩硼酸	B	-	-	-	奶和乳制品	-	-	-	-	醋和调味品	B	-	-	-
浓缩硫酸	B	-	-	-	矿脂	F	-	-	-	洗衣粉	B	-	-	-
木馏油	D	-	-	-	氯苯	F	-	-	-	水基油漆	A	-	-	-
甲酚	D	-	-	-	N-丁胺	F	-	-	-	白节油	F	-	-	-
切削油	F	-	-	-	萘	F	-	-	-	二甲苯	F	-	-	-
环己烯	C	-	-	-	石油	F	-	-	-	五氯苯酚	F	-	-	-
环己酮	A	-	-	-	氯化镍	A	-	-	-	硫酸锌	D	-	-	-
环己醇	C	-	-	-	20%的硝酸	B	-	-	-	风险指数				
死石灰	A	-	-	-	硝化苯	B	-	-	-	-	-	-	-	-
双丙酮醇	C	-	-	-	硝基苯	F	-	-	-	-	-	-	-	-
邻苯二甲酸二丁酯	E	-	-	-	硝基盐酸	F	-	-	-	-	-	-	-	-
二丁酯	E	-	-	-	硝基丙烷	B	-	-	-	-	-	-	-	-
二氯甲烷	F	-	-	-	油酸	A	-	-	-	-	-	-	-	-
二乙醇胺	E	-	-	-	草酸	A	-	-	-	-	-	-	-	-
稀释硫酸	B	-	-	-	煤油	-	-	-	-	-	-	-	-	-
邻苯二甲酸二辛酯	E	-	-	-	全氯乙烯	F	-	-	-	-	-	-	-	-
乙酸乙酯	C	-	-	-	过氧化氢	D	-	-	-	-	-	-	-	-
乙醇 (酒精)	D	-	-	-	石油乙醚	E	-	-	-	-	-	-	-	-
乙胺	A	-	-	-	石油产品	F	-	-	-	-	-	-	-	-
					磷酸	B	-	-	-	-	-	-	-	-

在任何场合都必须带上合适的长手套。

- 非常好
- 良好
- 一般
- 未知

本表格只给出了简单的指示。《渗透》给出了一种化学品穿过手套所需要的时间。它与手套的降质无关。因此，我们极力建议高度重视风险因素，确保用于操作化学品的手套得到检测。

Table of Chemical Agents and Their Related Protective Gloves

EN 374/1-3		Natural latex	Chloroprene	Nitrile	Vinyle PVC		Natural latex	Chloroprene	Nitrile	Vinyle PVC		Natural latex	Chloroprene	Nitrile	Vinyle PVC
Acetaldehyde	F					Ethylaniline	E					Polyester resins	F		
Acetic anhydride at 50 %	A					Ethylene glycol	F					Potash flakes	B		
Acetone	C					Fertilizers	C					Potash in concentrated washing detergent	B		
Acetone chloride	C					Fixing salts	E					Potassium acetate	B		
Ammonium acetate	B					Fluorides	B					Potassium bicarbonate	A		
Ammonium carbonate	B					Formaldehyde at 30 %	C					Potassium carbonate	B		
Ammonium chloride	B					Formic acid at 90%	B					Potassium chloride	B		
Ammonium nitrate	B					Formol (or formaldehyde)	-					Potassium cyanide	D		
Amyl acetate	A					Fragrances and essences	B					Potassium nitrate	B		
Amyl acid	C					Fuel oil	F					Potassium permanganate	D		
Aniline	E					Fuels	F					Potassium phosphates	D		
Animal fat	-					Fural (furfural or furfuraldehyde)	E					Potassium sulphate	B		
Asphalt	E					Gas oil	F					Propylene dichloride	F		
Benzaldehyde	E					Glacial acetic acid	B					Quick lime	B		
Benzene	E					Glycerine	-					Silicates	B		
Benzyl alcohol	E					Glycerophthalic paint	C					Soda flakes	B		
Bleach	B					Glycols	F					Soda in concentrated washing detergent	B		
Borax	A					Herbicides	A					Sodium bicarbonate	A		
Brake oil (lockheed)	F					Hexane	F					Sodium bisulphite	A		
Bromhydric acid	B					Household detergents	A					Sodium carbonate	-		
Bromides	C					Hydraulic fluids (esters)	C					Sodium chloride	B		
Butyl acetate	C					Hydraulic oils (petrol)	F					Sodium hydrochlorate	B		
Butyl alcohol (or n-butanol)	D					Hydrofluoric acid at 30 %	B					Sodium nitrate	B		
Calcium acetate	-					Hypochlorite de sodium	B					Sodium phosphates	B		
Calcium chloride	-					Isobutyl alcohol (or isobutanol)	A					Sodium sulphate	-		
Calcium fluophosphate	B					Isobutylketone	F					Soya oil	B		
Calcium hydroxide	-					Kerosene	F					Stearic acid	A		
Calcium hypochlorate	B					Lactic acid at 85%	A					Styrene	A		
Calcium nitrate	B					lard oil	-					Sulfites, bisulfites, hyposulfites	B		
Calcium phosphates	C					lubricating oils	F					Sulphuric ether (pharmacy)	A		
Car petrol	E					Magnesium oxide	-					Tartric acid	A		
Carbolic acid	D					Metho isobutyl ketone	F					THF - tetrahydrofurane	B		
Carbon tetrachloride	B					Methyl alcohol (or methanol)	C					Tin chloride	E		
Castor oil	-					Methyl acetate	E					Toluol	A		
Chloric acid	B					Methylamine	E					Tributyl phosphate	D		
Chlorine	B					Methylaniline	E					Trichlorethylene	F		
Chloroform	F					Methylcyclopentane	E					Trinitrobenzene	E		
Chlorhydric acid at 30 % and 5 %	B					Methylene chloride	C					Trinitrotoluol	E		
Citric acid	A					Methylethyl ketone	F					Triphenyl phosphate	E		
Concentrated ammonia	B					Methylformate	F					Turpentine	E		
Concentrated boric acid	B					Milk and dairy products	-					Vinegar and condiments	B		
Concentrated sulphuric acid	D					Mineral fat	F					Washing powders	B		
Creosote	D					Monochlorobenzene	F					Water-based paint	A		
Cresol	D					N-butylamine	F					White spirit	F		
Cutting oil	F					Naphtalene	F					Xylene	F		
Cyclohexane	C					Naphtha	F					Xylophene	F		
Cyclohexanol	A					Nickel chloride	A					Zinc sulphate	D		
Cyclohexanon	C					Nitric acid at 20%	B								
Dead lime	A					Nitrobenzene	B								
Diacetone alcohol	C					Nitrohydrochloric acid	F								
Dibutyl phtalate	E					Nitropropane	B								
Dibutylether	E					Oleic acid	A								
Dichloromethane	F					Oxalic acid	A								
Diethanolamine	E					Paraffin oil	-								
Dilute sulphuric acid	B					Perchlorethylène	F								
Diocyl phtalate	E					Peroxide	D								
Ethyl acetate	C					Petroleum ether	E								
Ethyl alcohol (or ethanol)	D					Petroleum products	F								
Ethylamine	A					Phosphoric acid	B								

Risk indicator

- Non toxic however contact may be harmful
- A** Can cause burns
- B** Risk of burns
- C** Toxic
- D** Highly toxic
- E** Highly toxic with secondary effects
- F** Highly toxic with irreversible and fatal risks

In all cases, it is essential to wear the suitable gloves.

- █ **Very good**
- █ **Good**
- █ **Average**
- █ **Not recommended**

This table only gives an indication. «PERMEATION» is the time it takes for a chemical to go through the glove. It has no relation to glove degradation. It is therefore highly recommended to take the risk indicator into account and to make sure that the glove has been tested for the chemical to be used.

通用手套

General Handling



订货号 Ref.: 22 320 92CN

双面点塑防滑工作手套
RESISTEX GRIP 2

适用于操作干燥或湿滑的物件。

- 优质涤棉无缝针织手套舒适吸汗且透气性佳
- PVC点塑为手套提供优异的防滑抓握性能，透气性好且操作灵活性
- 双面PVC点塑使左右手可交替使用，大大延长手套的使用寿命
- 长度：25厘米

Handling of dry and slippery parts.

- Cotton and polyester fiber blend ensures outstanding comfort and unique flexibility
- PVC dots offer excellent grip and dexterity
- PVC dots on both sides ensure an extended life cycle, making it cost-effective, since the glove is ambidextrous
- Length : 25 cm



订货号 Ref.: 20 941 40CN

天然乳胶涂层工作手套
DEXGRIP

产品适用于操作粗糙、湿滑和轻微锋利的物件，接触热防护可达250摄氏度。

- 优质灰色涤纶针织内衬，舒适且灵活性佳
- 手掌和指尖处有蓝色起皱天然乳胶涂层
- 接触热防护达到250摄氏度
- 耐磨性，耐撕裂性和防穿刺性俱佳
- 起皱乳胶涂层提高手套的防滑抓握性能
- 10针
- 长度：25厘米

For the handling of sharp, abrasive or slippery objects, for temperatures of contact until 250°C .

- Grey polyester knitted liner provides good comfort and dexterity
- Blue crinkled latex coating at the palm and fingertips
- Resistant to temperature up to 250°C
- Good resistance to abrasion, tear and perforation
- The crinkled latex provides excellent grip
- Gauge: 10
- Length: 25cm



订货号 Ref.: 22 322 33CN

丁腈涂层耐油防割防滑工作手套
Polytril Mix

重型操作工作手套，用于在多油多污和潮湿的环境中操作锋利的物件，适用于建筑，公共工程，钢铁和冶金行业。

- 符合欧标EN388 2级防割标准
- 优质涤棉内衬，舒适吸汗且灵活性佳
- 手掌和指尖处有粉末丁腈涂层，手套耐磨性佳且防渗油防渗水。
- 防滑丁腈涂层确保手套在油性环境中保持良好的抓握性能
- 针数：10针
- 长度：26厘米
- 颜色：黑色

Handling heavy and sharp objects in a greasy, damp and/or dirty environment. General handling in building and public works, steelworks and metallurgy.

- Certified to EN 388 cut resistance level 2
- Black polycotton seamless knitted liner provides good comfort, dexterity and breathability.
- Nitrile powder coating on palm and fingertips, providing excellent abrasion resistance, oil and water proof feature.
- Nitrile powder coating provides excellent grip in oily & greasy environment.
- Gauge: 10
- Length : 26cm
- Color : Black



订货号 Ref.	产品 Product	尺码 Sizes	EN 388				EN 407					
			a	b	c	d	a	b	c	d	e	f
22 320 92CN	双面点塑防滑工作手套	8, 9	1	1	3	1						
20 941 40CN	天然乳胶涂层工作手套	8 到 10	2	1	4	2	x	2	x	x	x	x
22 322 33CN	丁腈涂层耐油防割防滑工作手套	8 到 10	4	2	3	2						



订货号 Ref.: 21 002 51CN

涤纶PU涂层耐磨工作手套 Workeasy Black Black

产品适用于在干燥，微油或多尘的环境中操作精细物件。 For handling of fine products in a dry, slightly greasy or soiled environment.

- 黑色涤纶编织手套，经济的选择
- 手指和手掌部位有黑色PU涂层
- 有良好的触感，灵活性和耐磨性
- 13针
- 不含硅
- 长度：25厘米
- Black polyester knitted glove, an economical choice
- Black PU coating at the palm and fingertips
- Excellent tactility, dexterity and abrasion resistance
- Gauge 13
- Silicone free
- Length: 25 cm



订货号 Ref.: 21 002 50CN

尼龙PU涂层耐磨工作手套 灰色 /白色 PU First Grey/White

产品适用于汽车零部件，精密机械零件，电子安装，喷漆室检验区域，化妆品包装，照片冲印，光学产品，微电子和微型机械零件等需要精细动作并保护产品的场合。 For fine and flexible handling and product protection circumstance.

- 13 针优质尼龙针织
- 在手掌和指尖处有 PU 涂层
- 不含硅
- 良好的灵活性和耐磨性，为精细工作提供良好的触感
- 长度：25 厘米
- Lightweight white polyamide knitted gloves, gauge 13
- Polyurethane coating at the palm and fingertips
- Exceptional dexterity, excellent abrasion resistance
- Length: 25 cm



订货号 Ref.: 2132255CN



订货号 Ref.	产品 Product	尺码 Sizes	a	b	c	d
21 002 51CN	涤纶PU涂层工作手套	6 到 10	3	1	2	1
21 002 50CN	尼龙耐磨工作手套掌浸PU (灰色)	6 到 10	4	1	3	1
21 322 55CN	尼龙耐磨工作手套掌浸PU (白色)	6 到 10	4	1	3	1



订货号 Ref.: 22 322 40CN

尼龙指浸PU白色分类工作手套 Perfect Poly® Finger

产品适用于精密机械零件，电子安装，照片冲印，光学产品，微电子和微型机械零部件等需要精细动作并保护产品的场合。

- 13 针优质尼龙针织
- 在指尖有 PU 涂层，保护产品
- 不含硅油
- 良好的灵活性
- 长度：25 厘米

For fine and flexible handling and product protection circumstance.

- Lightweight white polyamide knitted gloves, gauge 13
- Polyurethane coating at fingertips
- Silicone free
- Exceptional dexterity, excellent abrasion resistance
- Length: 25 cm
- Color white



订货号 Ref.: 22 322 70CN

尼龙发泡丁腈涂层耐油防滑工作手套 POLYTRIL™ AIR

用于在多油多脂的环境中操作小物件，有良好的耐油和防滑性能。

- 黑色尼龙编织手套
- 在手掌和手指处加有黑色发泡丁腈涂层，透气性和防滑性俱佳
- 弹性编织手腕
- 13针
- 长度：25厘米
- 颜色：黑色

Fine handling in greasy or dirty environment.

- Black polyamide seamless knitted glove
- Black breathable nitrile foam coating at the palm and fingertips, providing good breathability and grip
- Elastic wrist
- Gauge: 13
- Length: 25 cm
- Color: Black



订货号 Ref.: 22 322 30CN

尼龙丁腈涂层耐油工作手套 POLYTRIL™

良好的操作性能，用于在多油和潮湿的环境中操作尖锐物件。

- 白色尼龙编织手套
- 在手掌和手指处加有灰色丁腈涂层
- 弹性编织手腕
- 13针
- 长度：25厘米
- 颜色：灰色涂层

Fine handlings in damp oily or greasy environment.

- White polyamide seamless knitted glove
- Grey oilproof nitrile coating on palm and on fingertips
- Gauge: 13
- Length: 25 cm
- Color: Grey coating



订货号 Ref.	产品 Product	尺码 Sizes	a b c d
22 322 40CN	尼龙指浸PU白色分类工作手套	6 到 10	轻微机械伤害
22 322 70CN	尼龙发泡丁腈涂层耐油防滑工作手套	6 到 10	4 1 2 1
22 322 30CN	尼龙丁腈涂层耐油工作手套	6 到 10	4 1 2 1

防割伤伤害 Cut Resistance

高性能复合材质防割手套 So Cut Extra Pro



订货号 Ref.: 22 325 22CN

适用于在干燥或微油的环境中操作重型锋利或高温物件 Heavy objects handling with cut risks in dry and greasy environment.

- 高性能针织防割手套符合欧标EN388 5级防割标准
- 接触热防护可达到100摄氏度
- 外层防护纤维为手套提供绝佳的防割性和良好的耐热性能
- 内层尼龙氨纶混合纤维增强手套的耐磨性和舒适度，柔软贴手，操作灵活
- 左右手可交替使用，可洗涤，性价比高
- 长度：25厘米
- 颜色：黄绿色
- Outstanding cut resistance (Level 5)
- Good contact heat resistance (100°C)
- Ambidextrous
- Comfortable to wear (nylon interior liner)

Automotive and Part Manufacturer

- Iron & steel
- Metal sheet
- Plastic industry
- Paper industry

新一代迪尼玛®防割手套 Perfect Cutting Grey First



订货号 Ref.: 21 322 45CN

适用于在干燥，微油和闷热的环境中操作锋利和粗糙的物件。 For the handling of sharp parts in a dry or slightly greasy environment for excellent dexterity and a good grip.

- 手套由高科技防割材料迪尼玛®纤维与莱卡混合针织而成，符合EN388 3级防割标准，防割性与灵活性俱佳
- 手腕部分为复合材质针织而成，达到EN388 5级防割标准，加强手腕部位的防护
- 手掌及指尖处有PU涂层，耐磨性及抓握性俱佳
- 迪尼玛®纤维轻质，舒适透气，且不起毛
- 可在90摄氏度的水温中反复洗涤，经久耐用
- 产品不含硅
- 长度：25厘米
- Excellent cut resistance (Level 3 at palm & level 5 at cuff)
- Excellent abrasion resistance (level 4)
- Excellent comfort and dexterity (Dyneema/Lycra knitted)
- Washable

Automotive and Part Manufacturer
Electronics

- Metal steel
- Glass industry
- Plastic industry



订货号 Ref.	产品 Product	尺码 Sizes	EN 388				EN 407					
			a	b	c	d	a	b	c	d	e	f
22 325 22CN	高性能复合材质防割手套	7 到 10	2	5	4	x	x	1	x	x	x	x
21 322 45CN	新一代迪尼玛®防割手套	6 到 10	4	3	4	2						

Dyneema® 防割手套 PERFECT CUTTING WHITE



订货号 Ref.: 22 322 44

产品适合在干燥和略微潮湿的工作环境中使用，用于操作容易使人割伤的物件。

- 符合欧标EN388 3级防割标准
- 白色 Dyneema®和 Lycra®编织手套，耐磨性和透气性俱佳
- 在手掌和手指尖数有PU涂层
- 灵活性机好，但不能用于接触高温物质
- 可洗涤
- 13针
- 经特殊处理不起毛
- 手腕：6 厘米
- 长度：24 厘米
- 颜色：白色

For the handling of cutting objects in a dry or slightly damp atmosphere.

- Certified to EN 388, cut resistance level 3
- White Dyneema®/Lycra® knitted, liner provides excellent abrasion resistance and breathability
- With polyurethane coating at the palm and fingertips
- Excellent dexterity
- Keep away from the heat
- Washable
- Gauge 13
- No linting
- Wrist 6 cm
- Length: 24 cm
- Color: white

贴皮KEVLAR® 耐磨防割手套 JUNKYARD DOG



订货号 Ref.: 20 321 01CN

产品适用于各种需要防割、耐磨、防穿刺的工作环境。可以在各种干燥和潮湿的环境中工作。

- 100% KEVLAR®纤维编织手套，符合欧标EN388 4级防割标准
- 在手指和手掌部分缝有牛皮以增加耐磨和耐穿刺性能
- 7针
- 长度：25厘米
- 颜色：黄色

For the heavy handling of cutting or perforating parts in a dry or damp environment.

- 100% KEVLAR® fibre knitted glove, certified to EN 388, cut resistance level 4
- Cowhide split leather reinforcement at the palm and fingers, providing good abrasion and perforation resistant
- Gauge 7
- Length: 25 cm
- Color: yellow

KEVLAR®丁腈点塑防割手套 KEVLAR® NITRILE COATED KEVLAR GLOVES



订货号 Ref.: 52/6647

主要应用：汽车(等交通运输行)组装、生产作业，一般生产制，金属、玻璃制品搬运、加工处。

- 不含可能引起过敏反应的乳胶蛋白
- EN388抗切割等级3级
- N型点塑，抓握力更好，抗磨损，更耐用
- 无缝合针织结构更舒适，减少手部疲劳
- 可以清洗，更经济
- 内层棉/聚酯混合衬里，穿戴更舒适
- 符合USDA, FDA和食品加工用途 21CFR规定

Fabricating, manufacturing, sharp part handling, sheet metal handling.

- Nitrile "N" coating improves grip and extends life due to better abrasion resistance.
- Knit construction provides superior comfort (no seams for chafing) and less hand fatigue.
- Machine washable or dry cleanable. Permits easy recycling for longer life and maximum value with minimal shrinkage.
- Ambidextrous design gives wearer four sides instead of two to further enhance value, also no sorting after recycling. The gloves also come in a variety of styles and weights to fit your needs.
- Blended design offers economical alternative. Puts Kevlar on outside for cut/slash protection and cotton/polyester on inside for worker comfort.
- Complies with USDA and FDA regulations, 21 CFR, for use in food processing.



订货号 Ref.	产品 Product	尺码 Sizes	a	b	c	d
22 322 44	Dyneema® 防割手套	8 和 9	4	3	4	2
20 321 01CN	贴皮KEVLAR® 耐磨防割手套	9	4	4	4	3
52/6647	KEVLAR®丁腈点塑防割手套	男式 (M) 女式 (S)	1	3	4	x



订货号 Ref.: 22 330 25CN

尼龙点塑防割手套 ABRATEX GRIP

产品设计用来操作易滑和有割伤危害的物件。

- 经济型防割手套,符合欧标EN388 2级防割标准
- 高密度尼龙编织手套
- 在手掌处有蓝色PVC点塑
- 10 针
- 长度: 25 厘米
- 颜色: 白色

Handling of slippery and cutting parts.

- Economical cut resistant glove, certified to EN 388, cut resistance level 2
- High tenacity nylon plated with cotton
- PVC dots on palm
- Gauge: 10
- Length: 25 cm
- Color: white



订货号 Ref.: 44 028 35CN

KEVLAR® 防割耐热护臂 ARACUT SLEEVE

产品设计用来保护工作人员的手掌和前臂免收割伤的危害。

- 双层KEVLAR®编织护臂,符合欧标EN388 3级防割标准
- 接触热防护达到100°C
- 大拇指处留有指孔
- 长度: 45厘米
- 颜色: 黄色

Protection of forearm and palm against cut.

- 2 ply KEVLAR® knitted sleeve, certified to EN 388, cut resistance level 3
- Resistant to contact heat up to 100°C
- Thumbhole
- Length: 45 cm
- Color: yellow



订货号 Ref.: 250100XR6302

金属防割手套 Whiting & Davis METAL MESH GLOVE

产品适合于食品加工, 制衣及采矿行业。

- 产品为加厚型金属网防割手套, 不分左右手, 内外可翻转使用
- 手腕处为编织条, 配有可调节快速搭扣

Reversible models are equipped with press-stud fastenings on each side of textile strap, making it easy to switch from one hand to the other, by simply turning the glove as well as the buckle inside out.

订货号 Ref.	产品 Product	尺码 Sizes	EN 388				EN 407						EN 1082	
			a	b	c	d	a	b	c	d	e	f		
22 330 25CN	尼龙点塑防割手套	8 和 9	2	2	4	x								
44 028 35CN	KEVLAR® 防割耐热护臂	均码	1	3	2	x	x	1	x	x	x	x		
250100XR6302	金属防割手套	0 (XXS) - 6 (XXL)												

防化学类伤害 Chemical Resistance



订货号 Ref.: 20 948 31

丁腈防化手套 POWERCOAT™ 948-31 NITRAF

产品具有较好耐磨防割性能,对于碳氢化合物的防护尤其出色。适用于石油化工行业、精细化工行业、脱脂、化学处理等与各种有机溶剂和酸碱试剂的接触的使用环境。

- 产品为棉衬里丁腈防化手套
- 表面有小圆型纹路
- 厚度: **0.5** 毫米
- 长度: **33** 厘米
- 颜色: 绿色

Product designed with a specific nitrile formulation for chemical resistance purpose. Suitable for handling with oil, fat and hydrocarbon derivatives, paint, varnish and non-kenotic solvents.

- Unsupported nitrile glove with cotton flock
- Pebble finish
- Thickness: 0.5 mm
- Length: 33 cm
- Color: green



订货号 Ref.: 20 950 20

氯丁橡胶防化手套 POWERCOAT™ 950-20 NEOFIT

产品适用于接触各种酸、碱、有机溶剂等化学品,对大多数化学品都具有较好的防护性能。

- 氯丁橡胶防护手套, 喷絮表面易于穿戴
- 表面有钻石形纹路
- 厚度: **0.72** 毫米
- 长度: **33** 厘米
- 颜色: 黑色

Battery handling, can be used with certain diluted acids.

- Neoprene unsupported glove
- Cotton flock interior
- Diamond pattern
- Thickness: 0.72 mm
- Length: 33 cm
- Color: black



订货号 Ref.: 20 950 25

氯丁橡胶防化长手套 POWERCOAT™ 950-25NEOFIT

产品设计用来操作各种化学物质,如腐蚀性的酸、酒精和油脂等。在日常操作、维护和清洁工作中都已广泛使用。

- 氯丁橡胶防护手套, 喷絮表面易于穿戴
- 表面有钻石形纹路, 抓物性能更出色
- 厚度: **0.72** 毫米
- 长度: **41** 厘米
- 颜色: 黑色

Handling chemicals (caustic acids, alcohols and solvents) Agriculture, Cleaning and Maintenance.

- Neoprene unsupported glove
- Flocked interior
- Diamond pattern
- Thickness: 0.72 mm
- Length: 41 cm
- Color: black

订货号 Ref.	产品 Product	尺码 Sizes	EN 388				EN374	
			a	b	c	d		
20 948 31	丁腈防化手套	8, 9 和 10	3	1	0	1	类型 3	JKL
20 950 20	氯丁橡胶防化手套	8, 9 和 10	3	1	1	1	类型 3	AKL
20 950 25	氯丁橡胶防化长手套	8, 9 和 10	3	1	1	1	类型 3	AKL



订货号 Ref.: LA102G
LA132G
LA172G
LA258G

无衬丁腈手套 NITRI GUARD PLUS™

- 符合USDA, FDA和食品加工用途21CFR规定
- 不含可能引起过敏反应的乳胶蛋白
- 轮廓线形设计, 自然贴合手部
- 丁腈材质, 较高耐油脂性能, 良好的抗穿刺性能
- 耐用, 舒适, 更经济
- 100% nitrile content offers superior resistance to cuts, snags, abrasions, and punctures.
- Gloves are free of latex proteins which can cause allergic reactions.
- Comply with USDA and FDA regulations, 21 CFR, for use in food processing.
- Gloves will not swell, sag or weaken from fat absorption.
- Out performs natural rubber, neoprene and vinyl gloves when exposed to solvents, caustics and animal fats.
- Available with flock lining for a soft, pleasant feel that absorbs perspiration and aids in donning and doffing.
- Curved shaped hand provides a natural fit.



订货号 Ref.: NK803
NK803IN (带保暖衬里)

带衬丁腈手套 NITRI-KNIT™

主要应用: 食品加工处理, 化学物品处理加工, 汽车, 航空等交通行业喷涂, 维修, 组装, 槽灌清洁, 渔业日常工作, 各行业通用清洁及机械操作

- 手符合USDA, FDA和食品加工用途21CFR规定
- 手不含可能引起过敏反应的乳胶蛋白
- 手手部经过永久性抗菌防霉处理, 更具防护性
- 手粗糙防滑纹路设计, 良好的油性、干湿抓握性能
- 手不同袖口设计, 也有弹性加长袖可选, 适用更多场合
- 手丁腈材质, 较高耐油脂性能, 良好的抗穿刺性能
- 手可清洗并长期使用, 更经济
- 手保温版*提供冷热防护, 推荐使用-23°C至149°C范围 (由于个人体征不同, 且对冷热感觉不同, 并不能保证手套良好适用于所有使用者和所有环境)
- High nitrile content offers superior resistance to cuts, snags, abrasions and punctures.
- Gloves are free of latex proteins which can cause allergic reactions.
- Comply with USDA and FDA regulations, 21 CFR, for use in food processing. Gloves will not swell, sag or weaken from fat absorption.
- Outperforms supported natural rubber, neoprene and vinyl gloves when exposed to solvents, caustics and animal fats.
- Interlock knit liner gives gloves added strength for resistance to cuts, snags, abrasions and punctures while adding comfort to wearer. Hand portion is treated with a permanent anti-bacterial and anti-mildew agent.
- Insulated versions provide additional protection from cold and heat. Recommended for temperatures from -10°F to 300°F (-23°C to 149°C)
- Unique textured finish provides excellent grip on oily, wet or dry objects.
- 5 hand sizes available for a comfortable fit.
- True dip coated glove has a permanent bond of nitrile to inner-liner. Won't peel apart like glued-in liners.
- NK803ES is available with extended sleeve (total length 26") for protection up to shoulders.
- Gloves can be laundered for extended use.
- To make gloves easy to sort after laundering, each Nitri-Knit glove contains color coded stitching inside the glove, in addition to having the size clearly marked on the outside.



订货号 Ref.: NK803ES



订货号 Ref.	产品 Product	尺码 Sizes	长度 Length	厚度 Thickness	a	b	c	d	
LA102G	无衬里丁腈手套, 内层消毒	7 到 10	33 厘米	0.28 毫米	4	0	0	1	JKL
LA132G	无衬里丁腈手套, 植绒衬里	7 到 10	33 厘米	0.38 毫米	4	0	0	1	JKL
LA172G	无衬里丁腈手套, 植绒衬里	8 到 10	33 厘米	0.43 毫米	4	0	0	1	JKL
LA258G	无衬里丁腈手套, 内层消毒	8 到 10	46 厘米	0.64 毫米	4	1	0	2	JKL
NK803	带衬里丁腈手套	8 到 10	30 厘米	-	4	1	2	1	JKL
NK803ES	长袖带衬里丁腈手套	8 到 10	66 厘米	-	4	1	2	1	JKL
NK803IN*	带保暖衬里丁腈手套	10	30 厘米	-	4	1	2	1	JKL



订货号 Ref.: PNLB1815/O

无衬天然橡胶手套

主要应用：食品加工处理，农业作业，汽车，航空等交通行业组装，各行业通用清洁及机械操作

- 符合USDA, FDA和食品加工用途21CFR规定
- 高品质天然橡胶, 更好的灵活性, 弹性和拉伸强度, 舒适耐用
- 手掌和手指浮纹提供良好的干湿物品抓握力
- 良好的防化性能, 抗撕裂及抗穿刺性能
- 穿戴感觉舒适, 灵巧
- 注意: 天然橡胶系列手套含天然乳胶蛋白成分, 极少数人可能会有过敏反应
- 100% natural rubber has excellent dexterity, elasticity, and tensile strength for long wear and comfort.
- Embossed palm and fingers offer a superior wet grip.
- Comply with USDA and FDA regulations, 21 CFR, for use in food processing.
- 18 mil thick gloves provide good chemical, tear and puncture resistance.
- Beaded cuff prevents tearing.
- Chlorinated for ease of donning and doffing.



订货号 Ref.: 850FWG

TRAWLER KING重型带衬PVC手套

主要应用：石油化工提炼，化学品处理，油脂处理，渔业，建筑业等艰苦作业环境

- PVC涂层, 耐油脂、酸、碱
- 特有粗糙防滑纹理, 良好油脂及干湿抓握性
- 特殊加厚涂层, 恶劣环境理想选择

Construction, handling oils and greases, mining, refining, petrochemical and fishing.

- PVC coating provides good chemical resistance to oils, greases, caustics, acids and alcohols
- Textured finish provides excellent grip on oily, wet or dry objects.
- Heavy duty coating is ideal for rough applications.

订货号 Ref.	产品 Product	尺码 Sizes	长度 Length	厚度 Thickness	EN388				EN374
					a	b	c	d	
PNLB1815/O	无衬天然橡胶手套	8 到10	38 厘米	0.5 毫米	4	0	0	1	-
850FWG	重型带衬PVC手套	10 XL	36 厘米	-	4	1	2	1	JKL



订货号 Ref.: B131R
B161R
B174
B324

丁基橡胶无衬手套 NORTH BUTYL™

遍布世界的军队、灾难预防机构及工业使用者的坚持选择！

主要应用：飞机、汽车等维修，化学物处理和加工，国家备战

- 无可比拟的防气体及水蒸气渗透性能
 - 特别适用于处理有毒物质
 - 对酮类（如MEK, MIBK, 丙酮等），酯类（如磷酸三甲苯酯、乙酸乙酯、乙酸戊酯等）有高效防护能力即使在低温下也能保持良好柔韧性及敏锐触感
 - 有“Grip-Saf”砂点手掌设计，适用于潮湿环境贴合手型设计，提供良好的舒适性
- Aircraft maintenance, automotive, chemical handling and processing, domestic preparedness, laboratory, Haz-Mat work, solvents (general)
- Highest permeation resistance to gas and water vapor for greater worker protection, especially when handling toxic substances.
 - Highly resistant to ketones (MEK, MIBK, acetone) and esters (tricresyl phosphate, amyl acetate, ethyl acetate).
 - Flexible and sensitive, even at lower temperatures.
 - Curved finger and hand design provides a better fit for greater worker comfort.
 - Available with “Grip-Saf” palm for enhanced grip.
 - GI styles are manufactured on govt. spec. APM hand forms and are built with the intention of meeting the requirements of MIL-DTL-43976D but are not fully tested, inspected, marked or packaged in accordance with this specification. Further inspection and testing including agent resistance testing at a government laboratory for Sarin (GB) and Mustard (HD) is available upon request for an additional charge. Contact North Customer Service for information.



订货号 Ref.: SSG
SSG29 (长袖)

复合膜防化手套 SILVER SHIELD / 4H

主要应用：汽车、飞机等交通工具维修，国家备战，危险物品处理，石油化工

- 超过280种化学物质防护：酸、碱、脂肪类、芳香族、氯化物、酮、酯等
 - 不含可能引起过敏反应的化学催化物
 - 不分左右手，经济方便
 - 可与其他手套配合使用，作为内层防护
 - 无墨型手套可选，无油墨污染
 - 另有同系列围裙、鞋套、袖套可选
- Aerospace, chemical processing and transporting, domestic preparedness, Haz-Mat work, petrochemical.
- Resistant to over 280 different chemicals, including alcohols, aliphatics, aromatics, chlorines, ketones and esters – Provides high performance protection in the most demanding applications.
 - Economical - Can be used as a disposable glove, without the need for cleaning and re-cycling.
 - Does not contain latex or chemical accelerators – Little chance of allergic reactions.
 - Ambidextrous design – Ideal for single glove use. Also, one glove can be discarded if necessary without wasting a pair.
 - Can be used as a secondary inner glove - Allows worker maximum protection in heavy duty jobs where the dangers of mechanical damage to gloves are high.
 - Ink-free versions of Silver Shield gloves are available. Please inquire with North Customer Service.



订货号 Ref.	产品 Product	尺码 Sizes	长度 Length	厚度 Thickness	a	b	c	d	
B131R	丁基橡胶无衬手套，粗糙表面	8 到 10	28 厘米	0.33 毫米	2	0	1	0	BCI
B161R	丁基橡胶无衬手套，粗糙表面	8 到 10	28 厘米	0.40 毫米	2	0	1	0	BCI
B174	丁基橡胶无衬手套，光滑表面	8 到 10	35 厘米	0.43 毫米	2	0	1	0	BCI
B324	丁基橡胶无衬手套，光滑表面	8 到 10	35 厘米	0.80 毫米	2	0	1	0	BCI
SSG	复合膜防化手套	8 到 10	36/40 厘米	0.07 毫米					AHL
SSG29	长袖复合膜防化手套	10	74 厘米	0.07 毫米					AHL

抛弃型手套 Disposable

听力防护系列
Hearing Protection

眼部防护系列
Eye & Face Protection

呼吸防护系列
Respiratory Protection

气检仪器系列
Instrumentation

手部防护系列
Protective Gloves

防护服系列
Protective Clothing

足部防护系列
Foot Protection

坠落防护系列
Fall Protection

电力防护系列
Electrical Safety Protection

消防救援防护
First Responder Products



订货号 Ref.: LA049PF
LA049IND



订货号 Ref.: T425PF



订货号 Ref.: T525

DEXI-TASK检查和工业级丁腈抛弃型手套

主要应用：食品加工处理, 电子(元器件)等精密加工组装, 汽车, 航空等交通行业喷涂包装, 检验, 清洁, 及小物件处理, 实验室

- 符合USDA, FDA和21CFR规定, 可用于食品加工处理
- 不含可能引起过敏反应的乳胶蛋白
- 卷边设计, 方便穿脱
- 专利丁腈材料, 更柔软, 延伸性好, 更耐用
- 不分左右手, 经济实用
- 有无粉和有粉两种可供选用
- 有工业等级 (LA049IND)

Food handling, packaging, inspections, small parts handling

- Provide more puncture resistance than natural rubber latex or vinyl gloves.
- Do not contain latex proteins that can cause allergic reactions.
- Comply with USDA and FDA regulations, 21 CFR, for use in food processing.
- Available in powdered (LA049) or powder-free (LA049PF).
- Industrial version available (LA049IND).

SENSI-TASK™ 检查级天然橡胶抛弃型手套

主要应用：食品加工处理, 电子(元器件)等精密加工组装, 汽车, 航空等交通行业喷涂, 包装, 检验, 清洁, 及小物件处理, 实验室

- 符合USDA, FDA和食品加工用途21CFR规定
- 卷边设计, 方便穿脱
- 天然橡胶, 更贴手, 更灵活
- 不分左右手, 经济实用
- 注意本品含天然乳胶蛋白成分, 极少数人可能会有过敏反应

Cleanup, electronic assembly, food handling, janitorial use, laboratories, packaging and inspections

- Superior dexterity.
- Comply with USDA and FDA regulations, 21 CFR, for use in food processing.
- Available in lightly powdered or powder-free.

VINYL-TASK 检查级乙烯基抛弃型手套

主要应用：食品加工处理, 包装, 检验, 清洁, 及小物件处理

- 符合USDA, FDA和食品加工用途21CFR规定
- 卷边设计, 方便穿脱
- 不分左右手, 经济实用

订货号 Ref. 产品 Product 尺码 Sizes 长度 Length 厚度 Thickness

LA049PF	无粉检查级丁腈抛弃型手套	S,M,L	23 厘米	0.13 毫米
LA049IND	低粉工业级丁腈抛弃型手套	S,M,L	23 厘米	0.13 毫米
T425PF	无粉检查级天然橡胶抛弃型手套	S,M,L	23 厘米	0.13 毫米
T525	低粉检查级乙烯基抛弃型手套	M,L	23 厘米	0.10 毫米



耐高温及焊接类应用 Heat Resistance and Welding Application



订货号 Ref.: 20 000 44

焊接手套 BLUE WELDING

产品适合焊接操作时使用。

- 由隔热粗革牛皮缝合而成
- 手心和手背处为软质皮革加固，手腕处为帆布质地
- 厚度：1.2毫米
- 长度：34厘米
- 颜色：蓝色

Designed for welding workers.

- Split leather
- Fully lined: palm and back with fleece, cuff with canvas
- Leather thickness: 1.2mm
- Length: 34 cm
- Color: blue



订货号 Ref.: 20 128 47

进口皮革焊接隔热手套 FOUNDRY LINED

产品适合焊接操作时使用。

- 由防水隔热粗革鹿皮缝合而成
- 在该手套的夹层中衬有4毫米厚的防火泡沫层，提供了更好的隔热防火的效果
- 18厘米牛皮护腕，内层为棉质衬里
- 手套由KEVLAR®线缝合连接
- 皮革厚度：1.3/1.5 毫米
- 长度：38厘米
- 颜色：红色

For Welding applications.

- Water repellent and heat resistant split leather glove
- Gunn cut, sewn and thumb, gauntlet type
- Hand lined with 4 mm flame resistant foam laminated on flame and heat resistant jersey
- 180 mm grain leather cuff lined with cotton canvas
- Stitch with KEVLAR® thread
- Thickness leather only 1.3/1.5 mm
- Length: 38 cm
- Color: red



订货号 Ref.: 20 586 98 (右)
20 586 99 (左)

镀铝皮革焊接隔热手套 ATLANTIC WELDING

产品适合在焊接操作和金属熔炼等工作环境中使用。

- 手掌和手腕背部为隔热粗革牛皮
- 手背镀铝，能有效防护辐射热的危害
- 在大拇指处缝有黑色隔热粗革牛皮，加强防护性能
- 手套由KEVLAR®线缝合连接
- 20 厘米护腕
- 长度：40 厘米
- 颜色：红色

Welding and smelting work.

- Palm and cuff in heat resistant cowhide leather
- Gunn cut, winged thumb reinforced with black grain heat resistant leather
- Back in preox aluminised fabric, resistant to radiant heat
- Fully lined glove
- Cuff: 20 cm
- Length: 40 cm
- Color: red

订货号 Ref.	产品 Product	尺码 Sizes	EN 388				EN 407					
			a	b	c	d	a	b	c	d	e	f
20 000 44	焊接手套	9 和 10	3	1	3	2	4	1	3	x	4	x
20 128 47	进口皮革焊接隔热手套	9 和 10	3	2	4	3	4	1	3	x	4	x
20 586 98(右)	镀铝皮革焊接隔热手套	9 和 10	4	2	4	4	4	1	4	4	4	x
20 586 99(左)	镀铝皮革焊接隔热手套	9 和 10	4	2	4	4	4	1	4	4	4	x



订货号 Ref.: 22 806 73

SUPERTHERMA 高性能隔热手套 SUPERTHERMA

用于操作500摄氏度以下的物体。

- KEVLAR®绒布缝制手套
- 最高防护温度可以达到500摄氏度
- 带有13厘米KEVLAR®护腕
- 长度: 32厘米
- 颜色: 黄色

For handling objects within 500 degree centigrade.

- KEVLAR® fabric stitching
- Resistant to temperature up to 500°C
- With 13 cm KEVLAR® cuff
- Length: 32 cm
- Color: yellow



订货号 Ref.: 22 013 36

KERMELO 高性能隔热手套 TOPFIRE KERMELO

产品适用于铸造、玻璃行业等。

- 1300克每平方米KERMELO毛巾布并指设计
- 最高防护温度可以达到800摄氏度
- 15厘米隔热防护护腕
- KEVLAR线缝合
- 良好的灵活性
- 长度: 37 厘米
- 颜色: 绿色

Founding, glass industry.

- Terry Mitt in Kermel 1300g/ m²
- Resistant to temperature up to 800°C
- Heat resistant split leather cuff: 15 cm
- KEVLAR yarn stitching
- Ambidextrous
- Length: 37 cm
- Color: green



订货号 Ref.: 22 751 12

ZETEX®高性能隔热手套 SUPERZETEX

产品设计用于金属冶炼、玻璃制造等面对超高温危害的工作环境。

- 并指设计, 由ZETEX® 和NOMEX®材料共同制成, 有极佳的防高温的性能
- 最高防护温度可以达到1100摄氏度
- 在大拇指处缝有KEVLAR®束条, 加强防护性能
- 灵活性和操作性能良好
- 颜色: 土黄色

Smelting works, glass works.

- ZETEX® mitt lined in NOMEX® with PBI reinforcement on the all hand and thumb
- Resistant to temperature up to 1100°C
- KEVLAR® yoke on each side of thumb
- Ambidextrous
- Color: khaki



订货号 Ref.	产品 Product	尺码 Sizes	a b c d				a b c d e f					
22 806 73	KEVLAR®高性能隔热手套	均码	2	5	2	4	4	4	4	1	3	x
22 013 36	KERMELO 高性能隔热手套	9	3	5	4	4	4	4	4	3	x	x
22 751 12	ZETEX® 高性能隔热手套	12	4	5	4	3	4	4	4	4	4	x



订货号 Ref.: 22 326 88

KEVLAR® 耐高温手套 ARATHERMA COMFORT TERRY

用于操作350摄氏度以下的物体。

- 特殊拇指设计，操作更灵活
- 手掌为KEVLAR®环形织法，隔热性能更好
- 最高防护温度可以达到350摄氏度
- 带有10厘米帆布护腕
- 颜色：黄色

For handling objects within 350°C.

- Gun cut, wing thumb
- Palm in Kevlar® terry loop out fabric
- Resistant to temperature up to 350°C
- With 10 cm canvas cuff
- Color: yellow



订货号 Ref.: 20 326 25CN (短袖)
22 326 35CN (长袖)

毛圈棉隔热防护手套 TERRY MIX/TERRY LONG

产品设计用于在较为干燥的环境中操作尖锐或高温的物体。 Handling of sharp and hot parts in dry environment.

- 灰色毛圈棉材质编织手套
- 毛巾面朝外
- 最高防护温度可以达到250摄氏度
- 长度：25 厘米(短袖)
35 厘米(短袖)
- 颜色：灰色

- Grey Cotton / Polyester Terry knitted glove
- Loop out
- Resistant to temperature up to 250°C
- Length: TERRY MIX: 25 cm
TERRY LONG: 35 cm
- Color: grey

订货号 Ref.

产品 Product

尺码 Sizes



a b c d



a b c d e f

22 326 88	KEVLAR® 耐高温手套	9	3	4	4	3	4	3	4	2	x	x
20 326 25CN	毛圈棉隔热防护手套 (短袖)	均码	2	3	3	x	x	2	x	x	x	x
22 326 35CN	毛圈棉隔热防护手套 (长袖)	8和9	2	3	3	x	x	2	x	x	x	x



订货号 Ref.: 51/7147

丁腈涂层耐高温手套 GRIP N® Hot Mill

主要应用：一般生产制造，普通维修、组装工作，食品制造

- 防间歇性温度最高可达250°C (400°F)
- 适用于高温、有蒸汽环境
- 双面丁腈点塑涂层，抓握力更好，寿命更长
- 针织结构，透气性好
- 另有加长护袖款，提供更多防护
- 符合USDA, FDA和食品加工用途21CFR规定

Automotive assembly, food processing, manufacturing

- Provides protection against intermittent heat up to 400° F.
- Nitrile palm coating provides excellent grip and longer life.
- Knit design allows hands to breathe, unlike cut/sewn hot mill gloves.
- Available with extended cuffs for additional protection above the wrist.
- Steamproof version has a three layer design:
- Inner layer of cotton provides hand comfort and wicks perspiration away from skin.
- Outer layer has excellent grip.
- Protective layer in between gloves provides resistance to steam.
- All three work together to provide a lightweight solution for working in hot, steamy applications.
- Complies with USDA and FDA regulations, 21 CFR, for use in food processing.



订货号 Ref.: 22 815 61

进口消防员手套 FIREMAN

消防员手套，具有防火耐高温、防割及防水功能。

- 防水牛皮表面
- 嵌入式大拇指设计
- KEVLAR®针织衬里
- 粗革护腕保护动脉
- KEVALR®线缝合
- 自动粘贴束带
- 长度：40 厘米
- 颜色：米色

For fire-fighting and protect the risks of fire, heat, cut and water.

- Water-repellent grain leather
- Added thumb
- Plated cotton KEVLAR® knitted lining
- Vein protection
- KEVLAR® thread assembly
- Fastening with self-adhesive band
- Length: 40 cm
- Color: beige

订货号 Ref.	产品 Product	尺码 Sizes	EN 388				EN 407					
			a	b	c	d	a	b	c	d	e	f
51/7147	丁腈涂层耐高温手套	男式 (中号)	1	3	4	x	x	2	4	1	x	x
22 815 61	进口消防员手套	9 和 10	3	2	2	2	4	1	3	2	x	x

防冻伤害

Cold Resistance



订货号 Ref.: 20 586 85

高性能防冻手套

CRYOGENIC

产品适合低温防护使用。尤其适用于操作、搬运与液氮相关的工作，对于少量液氮泼溅有很好的防护作用。

- 手部为米色防水牛皮，外层涂有硅树脂
- 手腕为粗革牛皮，配有2.3 厘米VELCRO 尼龙搭扣
- 特别的双层低温隔热设计，能够抵御零下170摄氏度的低温
- 厚度：0.8 到1.1 厘米
- 长度：40 厘米
- 颜色：土黄色

For the handling of liquid nitrogen, offering protection against small splattering.

- Water-repellent silicone cowhide grain leather glove
- Cuff in split leather, with tightening Velcro strip
- Cryogenic special double insulation
- Tested at -170 °C
- Thickness: 0.8/1.1 mm
- Length: 40 cm
- Color: Beige



订货号 Ref.: 70/6465NK

NORTH POLAR 皮质手掌耐低温手套

主要应用：寒冷作业，包括建筑、林业、公路工作等，物流搬运、冷藏等

- 3M Thinsulate® (新雪丽) 衬里提供防寒防护
- 防水的乙烯基衬里，保证手部干爽
- Gunn样式，翼型拇指设计，缝线处不易磨损，更耐用更舒适
- 推荐最低温度 - 38°C (-36°F)
- 罗口安全袖，提供更多防护

Cold conditions work including construction, forestry, snow clearing, de-icing, highway work, baggage handling, maintenance work and cold storage

- 3M Thinsulate® liner provides protection from cold.
- Waterproof vinyl liner prevents hands from getting wet.
- Extended knitwrist provides additional weather protection.
- Gunn cut with wing thumb for comfort.
- Colors to match your favorite sports team.
- Recommended for temperatures down to -36°F (- 38°C)*

订货号 Ref.

产品 Product

尺码 Sizes



a b c d



a b c

20 586 85

高性能防冻手套

9 和 10

3 2 2 2

2 2 x

70/6465NK

皮质手套耐低温手套

男式(M)



订货号 Ref.: HP100MY

100级洁净室天然橡胶抛弃型手套 CLEANROOM LATEX DISPOSABLE GLOVE

主要应用：制药、食品、化妆品等行业的洁净室作业，电子(元器件)等精密加工组装，一般实验室、洁净室

- 适用于Class100级实验室
- 洁净室包装,防止污染危害
- 袖口卷边,易于穿戴
- 磨砂防滑设计,灵活舒适
- 颗粒及离子污染极低
- 注意本品含天然乳胶蛋白成分,极少数人可能会有过敏反应

Cleanroom operations

- 100% latex rubber
- Cleanroom packaged for protection against airborne contamination. Cleanroom compatible packaging and labeling materials.
- Low modulus formulation is stretchier for a more comfortable fit.
- Antistatic formulation eliminates static discharge in many cases.
- Rolled cuff prevents tearing when donning.



订货号 Ref.: CE412W

100级洁净室丁腈抛弃型手套 CLEANROOM NITRILE DISPOSABLE GLOVE

主要应用：制药、食品、化妆品等行业的洁净室作业，电子(元器件)等精密加工组装，一般实验室、洁净室

- 适用于Class100级实验室
- 不含可能引起过敏反应的乳胶蛋白
- 洁净室包装,防止污染危害
- 袖口卷边,易于穿戴
- 磨砂防滑设计,灵活舒适
- 颗粒及离子污染极低

Cleanroom operations

- Cleanroom packaged for protection against airborne contamination. Double bagged with cleanroom compatible packaging and labeling materials.
- State-of-the-art cleaning process reduces particulate contamination.
- Low modulus formulation is stretchier for a more comfortable fit.
- Antistatic formulation eliminates static discharge in many cases.
- 100% nitrile rubber does not contain allergy-causing proteins.
- Rolled cuff prevents tearing when donning.



订货号 Ref.	产品 Product	尺码 Sizes	长度 Length	厚度 Thickness
HP100ND	洁净室天然橡胶抛弃型手套	S, M, L	30 厘米	0.16 毫米
CE412W	洁净室丁腈抛弃型手套	S, M, L	30 厘米	0.10 毫米



订货号 Ref.: ATCP1815/O

ANTIC - 无衬天然橡胶手套

主要应用: 粉尘车间清洁、日常核实验室操作和加工材料的搬运、存储和净化。

- 100%天然高密度橡胶, 抗磨蚀、撕裂和切割性能等非常好
- 菱形凸纹手掌, 能抓牢干湿物品
- 手套袖口标明尺码, 净化后易于配对
- 经认证可焚化
- 卷边袖口, 增加强度, 不易撕裂
- 符合军用规格MIL-G-82242D的要求
- 经过氯化处理, 易于脱戴

Power plant clean-ups, routine nuclear laboratory procedures and processing of materials for shipping, storage or decontamination.

- High density, 100% natural rubber has excellent resistance against abrasions, snags, cuts, etc.
- Diamond embossed palm has a positive grip in wet and dry applications.
- Embossed hand sizes makes sorting after decontamination easy.
- Gloves are certified incinerable.
- Beaded cuff adds strength and tear resistance.
- Meets MIL-G-82242D.
- Chlorinated finish for ease in donning and doffing.



订货号 Ref.: AK1815/O

AK洁净室天然橡胶防化手套

主要应用: 处理腐蚀性物品或一般酸碱物品, 一般实验室、洁净室

- 100%天然橡胶, 抗磨蚀、撕裂和切割性能良好
- 菱形凸纹手掌, 更好的抓握性能
- 双重洁净室包装, 标签和包装材料均可用于洁净室
- 尺码浮雕设计, 无油墨污染
- 先进无粉生产环境, 减少污染
- 经IEST-RP-CC005.3 (修订版) 颗粒及离子测试
- ASTM739防渗透测试
- 注意本品含天然乳胶蛋白成分, 极少数人可能会有过敏反应

Cleanroom operations such as acid etching, handling etching and cleaning acids and caustics, lab room maintenance

- 100% natural rubber latex has excellent dexterity and elasticity.
- Powder-free manufacturing process reduces particulate and extractable contamination.
- Diamond embossed palm has excellent dry and wet grip.
- Cleanroom packaged to protect gloves from airborne contamination. Double bagged with cleanroom compatible packaging and labeling materials.
- Size embossed on gloves so there is no ink to contaminate process.
- Testing: IEST-RP-CC005.3 (modified) particulate and extractables; ASTM 739 permeation.



订货号 Ref.	产品 Product	尺码 Sizes	长度 Length	厚度 Thickness	a	b	c	d
ATCP1815/O	无衬天然橡胶手套, 橘黄色	8 到 10	38 厘米	0.38 毫米	3	0	1	1
AK1815/O	洁净室天然橡胶防化手套	7 到 10	38 厘米	0.5 毫米	3	0	1	1



丁基合成橡胶干箱手套 BUTYL GLOVEBOX GLOVES

主要应用：核电、防御等，医药、生物技术生产，半导体和一般制造业干箱操作，高度化学危害场合，如化学武器等，实验室操作

- 绝佳防蒸汽、气体渗透性能
- 广泛适用于有毒化学品防护
- 对酮类、酯类有高效保护能力
- 低温环境下柔韧性仍然保持良好
- 采用溶剂型,多重浸渍工艺
- 手感柔软,舒适;拉伸强度高,耐意外撕裂
- 符合USDA, FDA和21CFR规定, 可用于食品加工处理
- 特有不分左右手互换款式,更经济
- 尾字母A表示不分左右手,可互换使用
- 干箱手套可根据客户具体需求定制,请联系我们

Glovebox operations in the nuclear, defense, pharmaceutical, biotech, semi-conductor and manufacturing industries. Particularly suited to applications involving highly toxic chemical hazards, such as chemical weapons.

- Butyl provides the highest permeation resistance to vapors and gases, as well as exceptional resistance to a broad range of toxic chemicals, making it the only suitable glove choice for many critical applications.
- Highly resistant to ketones (MEK, MIBK, acetone) and esters (tricresyl phosphate, amyl acetate, ethyl acetate).
- Butyl has a soft and flexible feel, even at low temperatures, which reduces hand fatigue and enhances worker comfort.
- Solvent based, multi-dip manufacturing process provides multiple layers of polymer (like a glove within a glove) which results in a glove of superior quality.
- Ambidextrous and hand specific styles available.
- Complies with USDA and FDA regulations, 21 CFR, for use in food processing.

订货号 Ref.	产品 Product	尺码 Sizes	长度 Length	厚度Thickness	袖口直径
7B1532	丁基合成橡胶干箱手套	9Q	81 厘米	0.4 毫米	177.8 毫米
7B1532A	丁基合成橡胶干箱手套,左右手可互换	9Q	81 厘米	0.4 毫米	177.8 毫米
8B1532	丁基合成橡胶干箱手套	8H,9Q,10H	81 厘米	0.4 毫米	203.2 毫米
8B1532A	丁基合成橡胶干箱手套,左右手可互换	9Q,10H	81 厘米	0.4 毫米	203.8 毫米
7B3032	丁基合成橡胶干箱手套	9Q	81 厘米	0.8 毫米	177.8 毫米
7B3032A	丁基合成橡胶干箱手套,左右手可互换	9Q	81 厘米	0.8 毫米	177.8 毫米
8B3032	丁基合成橡胶干箱手套	8H,9Q,10H	81 厘米	0.8 毫米	203.2 毫米
8B3032A	丁基合成橡胶干箱手套,左右手可互换	9Q,10H	81 厘米	0.8 毫米	203.2 毫米



氯丁橡胶干箱手套 NEOPRENE GLOVEBOX GLOVES

主要应用：用于核电，防御，医药，生物技术，半导体和制造业中的干箱操作。

- 使用高品质氯丁橡胶制成，防蒸汽和水的渗透
- 对广泛的化学品都有防护作用，包括油脂，燃料和丙酮
- 采用溶剂型，多重浸渍过程生产出复合聚合物层（就像一层层套起来的手套），造就出品非凡的手套
- 高拉伸强度，耐意外撕裂
- 延伸性好，非常柔韧，为需要良好触感和灵活性的工作而设计
- 耐磨损性强，使用寿命长
- 有左右手可互换和左右手特定两种样式
- 袖口直径7"(177.8mm)，8"(203.2mm)和10"(254mm)
- 符合USDA、FDA和食品加工用途的21CFR的要求

Glovebox operations in the nuclear, defense, pharmaceutical, biotech, semi-conductor and manufacturing industries.

- Manufactured from premium quality milled neoprene which provides high permeation resistance to vapors & gases.
- Resistant to a broad range of chemicals, including oils, greases, fuels and acetone.
- Solvent based, multi-dip manufacturing process provides multiple layers of polymer (like a glove within a glove) which results in a glove of superior quality.
- High tensile strength provides resistance to accidental tears.
- Good elongation provides flexibility; ideal for work requiring dexterity and sensitivity.
- Good abrasion resistance helps provide a long service life.
- Ambidextrous and hand specific styles available.
- Complies with USDA and FDA regulations, 21 CFR, for use in food processing.

订货号 Ref.	产品 Product	尺码 Sizes	长度 Length	厚度 Thickness	袖口直径
7N1532	氯丁橡胶材料干箱手套	9Q	81 厘米	0.4 毫米	177.8 毫米
7N1532A	氯丁橡胶材料干箱手套,左右手可互换	9Q	81 厘米	0.4 毫米	177.8 毫米
8N1532	氯丁橡胶材料干箱手套	8H,9Q,10H	81 厘米	0.4 毫米	203.2 毫米
8N1532A	氯丁橡胶材料干箱手套,左右手可互换	9Q,10H	81 厘米	0.4 毫米	203.2 毫米
7N3032	氯丁橡胶材料干箱手套	9Q	81 厘米	0.8 毫米	177.8 毫米
7N3032A	氯丁橡胶材料干箱手套,左右手可互换	9Q	81 厘米	0.8 毫米	177.8 毫米
8N3032	氯丁橡胶材料干箱手套	8H,9Q,10H	81 厘米	0.8 毫米	203.2 毫米
8N3032A	氯丁橡胶材料干箱手套,左右手可互换	9Q,10H	81 厘米	0.8 毫米	203.2 毫米
10N3032A	氯丁橡胶材料干箱手套,左右手可互换	9Q	81 厘米	0.8 毫米	254 毫米



氯丁橡胶/Hypalon® 材料干箱手套 Hypalon®/NEOPRENE GLOVEBOX GLOVES

主要应用：用于核电，防御，医药，生物技术，半导体和制造业中的干箱手套操作。

- 氯丁橡胶层高度防水和蒸汽的渗透，同时也有防化作用，包括油脂，燃料和丙酮
- Hypalon 外层提供卓越的抗氧化和氧化物的作用，例如：酒精，碱和酸类。同时对人工光照和日光的 UV 照射都有高度防护作用
- Hypalon 具有较高的耐磨损性，延长使用寿命
- 不同颜色的氯丁橡胶和Hypalon层让您辨认手套的损坏和是否过度使用
- 白色 Hypalon表面不会掩藏污渍，容易清洗
- 采用溶剂型，多重浸渍生产过程制成出复合聚合物层（就像一层层套起来的手套），造就出品质非凡的手套
- 高拉伸强度，耐意外撕裂
- 延伸性好，非常柔韧，为需要良好触感和灵活性的工作而设计

Glovebox operations in the nuclear, defense, pharmaceutical, biotech, semi-conductor and manufacturing industries.

- Neoprene layer provides high permeation resistance to vapors & gases as well as chemical resistance to oils, greases, fuels and acetone.
- Hypalon outer layer provides superior resistance to ozone and oxidizing chemicals such as alcohols, alkalis and acids. Also highly resistant to the effects of UV radiation in both artificial light and sunlight.
- Hypalon also offers improved abrasion resistance, to further extend glove service life.
- Different colored neoprene and Hypalon layers provide a visual indication of glove damage or excessive wear.
- White Hypalon surface will not hide contamination and is easily cleaned.
- Solvent based, multi-dip manufacturing process provides multiple layers of polymer (like a glove within a glove) which results in a glove of superior quality.
- Good tensile strength provides resistance to accidental tears.
- Good elongation provides flexibility for work requiring dexterity and sensitivity.
- Ambidextrous and hand specific styles available.

订货号 Ref.	产品 Product	尺码 Sizes	长度 Length	厚度Thickness	袖口直径
8NY3032	氯丁橡胶/Hypalon® 材料干箱手套	8H,9Q,10H	81 厘米	0.8 毫米	203.2 毫米
8NY3032A	氯丁橡胶/Hypalon® 材料干箱手套 左右手可互换	9Q,10H	81 厘米	0.8 毫米	203.2 毫米
7NY3032	氯丁橡胶/Hypalon® 材料干箱手套	9Q	81 厘米	0.8 毫米	177.8 毫米
7NY3032A	氯丁橡胶/Hypalon® 材料干箱手套 左右手可互换	9Q	81 厘米	0.8 毫米	177.8 毫米

Hypalon®材料干箱手套 Hypalon® DRYBOX GLOVES

主要应用：粉尘车间清洁、日常核实验室操作和加工材料的搬运、存储和净化。

- Hypalon 提供卓越的抗氧化和氧化物的作用，例如：酒精，碱和酸类。同时对人工光照和日光的 UV 照射都有高度防护作用
- 对人工光照和日光的 UV 照射都有高度防护作用
- C强的耐磨损性，延长使用寿命
- 白色 Hypalon表面不会掩藏污渍，清洗容易，自然柔软，舒适
- 采用溶剂型，多重浸渍过程生产出复合聚合物层（就像一层层套起来的手套），造就出品质非凡的手套
- 高拉伸强度，耐意外撕裂

Glovebox operations in the nuclear, defense, pharmaceutical, biotech, semi-conductor and manufacturing industries.

- Hypalon provides superior resistance to ozone and oxidizing chemicals such as alcohols, alkalis and acids.
- Highly resistant to the effects of UV radiation in both artificial light and sunlight.
- Very high abrasion resistance provides long glove service life.
- White Hypalon surface will not hide contamination and is easily cleaned (important for “clean” applications, such as in the pharmaceutical industry).
- Natural soft feel for greater worker comfort.
- Solvent based, multi-dip manufacturing process provides multiple layers of polymer (like a glove within a glove) which results in a glove of superior quality.
- Good tensile strength provides resistance to accidental tears.
- Ambidextrous and hand specific styles available.



订货号 Ref.	产品 Product	尺码 Sizes	长度 Length	厚度 Thickness	袖口直径
7Y1532	Hypalon®材料干箱手套	9Q	81 厘米	0.4 毫米	177.8 毫米
7Y1532A	Hypalon®材料干箱手套, 左右手可互换	9Q	81 厘米	0.4 毫米	177.8 毫米
8Y1532	Hypalon®材料干箱手套	8H,9Q,10H	81 厘米	0.4 毫米	203.2毫米
8Y1532A	Hypalon®材料干箱手套, 左右手可互换	9Q,10H	81 厘米	0.4 毫米	203.2毫米
10Y1532A	Hypalon®材料干箱手套, 左右手可互换	9Q	81 厘米	0.4 毫米	254毫米
7Y3032	Hypalon®材料干箱手套	9Q	81 厘米	0.8 毫米	177.8 毫米
8Y3032	Hypalon®材料干箱手套	8H,9Q,10H	81 厘米	0.8 毫米	203.2 毫米
8Y3032A	Hypalon®材料干箱手套, 左右手可互换	9Q,10H	81 厘米	0.8 毫米	203.2 毫米



加铅氯丁橡胶干箱手套 LEAD-LOADED NEOPRENE GLOVEBOX GLOVES

主要应用：用于核电，防御工业中的干箱操作。

- 0.1毫米铅当量，可衰减软伽玛辐射
- 高拉伸强度，耐意外撕裂
- 使用高品质碾碎氯丁橡胶制成，提供极好的防蒸汽和气体的渗透性能
- 对广泛的化学品都有防护作用，包括油脂，燃料和丙酮
- 不同颜色的氯丁橡胶和铅层（橘红色）看出手套的损坏和过度使用
- 出色的耐磨蚀性，延长使用寿命
- 采用溶剂型，多重浸渍过程生产出复合聚合物层（就像一层层套起来的手套），造就出品质非凡的手套

Glovebox operations in the nuclear and defense industries.

- 0.1 mm lead equivalency for attenuation of soft gamma radiation.
- High tensile strength provides resistance to accidental tears.
- Manufactured from premium quality milled neoprene which provides high permeation resistance to vapors & gases.
- Resistant to a broad range of chemicals, including oils, greases, fuels and acetone.
- Different colored neoprene and lead-loaded (orange) layers provide a visual indication of glove damage or excessive wear.
- Good abrasion resistance helps provide a long service life.
- Solvent based, multi-dip manufacturing process provides multiple layers of polymer (like a glove within a glove) which results in a glove of superior quality.
- Ambidextrous and hand specific styles available.

订货号 Ref.	产品 Product	尺码 Sizes	长度 Length	厚度 Thickness	袖口直径
8NLL3032	加铅氯丁橡胶材料干箱手套	8H,9Q,10H	81 厘米	0.8 毫米	203.2 毫米
8NLL3032A	加铅氯丁橡胶材料干箱手套， 左右手可互换	9Q,10H	81 厘米	0.8 毫米	203.2 毫米
7NLL3032	加铅氯丁橡胶材料干箱手套	9Q	81 厘米	0.8 毫米	177.8 毫米



Hypalon® 加铅氯丁橡胶手套 LEAD-LOADED Hypalon® – NEOPRENE

主要应用：用于核电，防御工业中的干箱操作。

- 0.1毫米的铅当量，可衰减软伽玛辐射
- 氯丁橡胶层高度防蒸汽和气体的渗透，同时也有防化作用，包括油，合成油脂，燃料和丙酮
- Hypalon 外层提供卓越抗臭氧和醇、碱、酸等具有氧化性的化学品的能力。同时对人工光照和日光的 UV 照射都有高度防护作用
- Hypalon 也具有较高的耐磨损性，使用寿命长。
- 不同颜色的氯丁橡胶和铅层（橘红色）让您可以看出手套的损坏和过度使用。
- 白色Hypalon表面不会掩盖污渍，容易清洗。
- 采用溶剂型，多重浸渍过程生产出复合聚合物层（就像一层层套起来的手套），造就出品质非凡的手套。
- 高拉伸强度，耐意外撕裂。
- 有左右手可互换和左右手特定两种样式。

Glovebox operations in the nuclear and defense industries.

- 0.1 mm lead equivalency for attenuation of soft gamma radiation.
- Neoprene layer provides high permeation resistance to vapors & gases as well as chemical resistance to oils, greases, fuels and acetone.
- Hypalon outer layer provides superior resistance to ozone and oxidizing chemicals such as alcohols, alkalis and acids. Also highly resistant to the effects of UV radiation in both artificial light and sunlight.
- Hypalon also offers improved abrasion resistance, to further extend glove service life.
- Different colored neoprene, lead-loaded (orange) and Hypalon layers provide a visual indication of glove damage or excessive wear.
- White Hypalon surface will not hide contamination and is easily cleaned.
- Solvent based, multi-dip manufacturing process provides multiple layers of polymer (like a glove within a glove) which results in a glove of superior quality.
- Good tensile strength provides resistance to accidental tears.
- Ambidextrous and hand specific styles available.

订货号 Ref.	产品 Product	尺码 Sizes	长度 Length	厚度Thickness	袖口直径
8NLY3032	Hypalon® 加铅氯丁橡胶手套	8H,9Q,10H	81 厘米	0.8 毫米	203.2 毫米
8NLY3032A	Hypalon® 加铅氯丁橡胶手套， 左右手可互换	9Q	81 厘米	0.8 毫米	203.2 毫米
7NLY3032	Hypalon® 加铅氯丁橡胶手套	9Q	81 厘米	0.8 毫米	177.8 毫米
7NLY3032A	Hypalon® 加铅氯丁橡胶手套， 左右手可互换	9Q	81 厘米	0.8 毫米	177.8毫米

加铅Hypalon® 材料干箱手套 LEAD-LOADED Hypalon® GLOVEBOX GLOVES

主要应用：用于核电，防御工业中的干箱操作。

- 0.1毫米铅当量，可衰减软伽玛辐射。
- Hypalon 外层提供卓越的抗氧化和氧化物的作用，例如：酒精，碱和酸类。
- 对人工光照和日光的 UV 照射都有高度防护作用。
- 出色的耐磨损性，使用寿命长。
- 白色 Hypalon 表面不会掩藏污渍，容易清洗。
- 采用溶剂型，多重浸渍过程生产出复合聚合物层（就像一层层套起来的手套），造就出品质非凡的手套。
- 高拉伸强度，耐意外撕裂。
- 不同颜色的Hypalon 层和铅层（橘红色）让您轻松可以看出手套的是否已经损坏或过度使用。
- 有左右手可互换和左右手特定两种样式

Glovebox operations in the nuclear and defense industries.

- 0.1 mm lead equivalency for attenuation of soft gamma radiation.
- Hypalon provides superior resistance to ozone and oxidizing chemicals such as alcohols, alkalis and acids.
- Highly resistant to the effects of UV radiation in both artificial light and sunlight.
- Very high abrasion resistance provides long glove service life.
- White Hypalon surface will not hide contamination and is easily cleaned.
- Solvent based, multi-dip manufacturing process provides multiple layers of polymer (like a glove within a glove) which results in a glove of superior quality.
- Good tensile strength provides resistance to accidental tears.
- Different colored lead-loaded (orange) and Hypalon layers provide a visual indication of glove damage or excessive wear.
- Ambidextrous and hand specific styles available.



订货号 Ref.	产品 Product	尺码 Sizes	长度 Length	厚度Thickness	袖口直径
8YLY3032	加铅Hypalon® 材料干箱手套	8H,9Q,10H	81 厘米	0.8 毫米	203.2 毫米
8YLY3032A	加铅Hypalon® 材料干箱手套， 左右手可互换	9Q	81 厘米	0.8 毫米	203.2 毫米
7YLY3032	加铅Hypalon® 材料干箱手套	9Q	81 厘米	0.8 毫米	177.8 毫米
7YLY3032A	加铅Hypalon® 材料干箱手套， 左右手可互换	9Q	81 厘米	0.8 毫米	177.8 毫米



短款氯丁橡胶干箱手套

NEOPRENE SHORT GLOVEBOX GLOVES

主要应用：用于制药，防御，核电，生物技术，半导体和制造业中的干箱操作。

- 使用高品质碾碎氯丁橡胶制作，提供极好的防蒸汽和气体的渗透性能
- 对广泛的化学品都有防护作用，包括油，合成油脂，燃料和丙酮
- 采用溶剂型，多重浸渍生产过程生产出复合聚合物层（就像一层层套起来的手套），造就出品质非凡的手套
- 高拉伸强度，耐意外撕裂
- 延伸性好使其非常柔韧，特别适合需要敏感性和灵活性的工作
- 出色的耐磨损性，使用寿命长
- 左右手可互换
- 配合护袖一起使用
- 符合USDA、FDA和21CFR的要求，可以用于食品加工

Glovebox operations in the pharmaceutical, biotech, semi-conductor, nuclear, defense, and manufacturing industries.

- Manufactured from premium quality milled neoprene which provides high permeation resistance to vapors & gases.
- Resistant to a broad range of chemicals, including oils, greases, fuels and acetone.
- Solvent based, multi-dip manufacturing process provides multiple layers of polymer (like a glove within a glove) which results in a glove of superior quality.
- High tensile strength provides resistance to accidental tears.
- Good elongation provides flexibility; ideal for work requiring dexterity and sensitivity.
- Good abrasion resistance helps provide a long service life.
- Ambidextrous.
- For use with sleeves.
- Complies with USDA and FDA regulations, 21 CFR, for use in food processing.

订货号 Ref.	产品 Product	尺码 Sizes	长度 Length	厚度 Thickness
N103A	短款氯丁橡胶干箱手套	8,9,10	33 厘米	0.26 毫米
N204A	短款氯丁橡胶干箱手套	8,9,10	35 厘米	0.5 毫米

短款Hypalon®干箱手套 Hypalon® SHORT GLOVEBOX GLOVES

主要应用：粉尘车间清洁、日常核实验室操作和加工材料的搬运、存储和净化。



- Hypalon提供了出色的抗臭氧和具有氧化性的醇、碱、酸等化学品的能力
- 对人工光照和日光的UV照射都有较高的防护性能
- 出色的耐磨损性，使用寿命更长
- 白色Hypalon表面不会掩藏污渍，容易清洗(特别适用于“清洁”很重要的应用，如医药行业)
- 自然柔软，带来更多舒适
- 采用溶剂型，多重浸渍过程生产出复合聚合物层(就像一层层套起来的手套)，造就出品质非凡的手套
- 高拉伸强度，有效防止意外撕裂
- 左右手可互换和左右手特定两种样式
- 配合护袖使用

Glovebox operations in the pharmaceutical, biotech, semi-conductor, nuclear, defense, and manufacturing industries.

- Hypalon provides superior resistance to ozone and oxidizing chemicals such as alcohols, alkalis and acids.
- Highly resistant to the effects of UV radiation in both artificial light and sunlight.
- Very high abrasion resistance provides long glove service life.
- White Hypalon surface will not hide contamination and is easily cleaned (important for “clean” applications, such as in the pharmaceutical industry).
- Natural soft feel for greater worker comfort.
- Solvent based, multi-dip manufacturing process provides multiple layers of polymer (like a glove within a glove) which results in a glove of superior quality.
- Good tensile strength provides resistance to accidental tears.
- Ambidextrous and hand specific styles available.
- For use with sleeves.

订货号 Ref.	产品 Product	尺码 Sizes	长度 Length	厚度 Thickness
Y103	短款Hypalon®干箱手套	8,9,10	33 厘米	0.26 毫米
Y103A	短款Hypalon®材料干箱手套,左右手可互换	8,9,10	33 厘米	0.26 毫米
Y154A	短款Hypalon®材料干箱手套,左右手可互换	8,9,10	35 厘米	0.4 毫米
Y254A	短款Hypalon®材料干箱手套,左右手可互换	8,9,10	35 厘米	0.63 毫米

Hypalon® 护袖

Hypalon® SLEEVES

主要应用：用于制药，防御，核电，生物技术，半导体和制造业中的干箱操作。

- Hypalon提供了出色的抗臭氧和具有氧化性的醇、碱、酸等化学品的能力。
- 对人工光照和日光的UV照射都有较高的防护性能。
- 出色的耐磨损性，使用寿命更长。
- 白色Hypalon表面不会掩盖污渍，容易清洗(特别适用于“清洁”很重要的应用，如医药行业)。
- 自然柔软，带来更多舒适。
- 采用溶剂型，多重浸渍过程生产出复合聚合物层(就像一层层套起来的手套)，造就出品质非凡的手套。
- 高拉伸强度，有效防止意外撕裂。
- 和短款干箱手套使用。

Glovebox operations in the pharmaceutical, biotech, semi-conductor, nuclear, defense, and manufacturing industries.

- Hypalon provides superior resistance to ozone and oxidizing chemicals such as alcohols, alkalis and acids.
- Highly resistant to the effects of UV radiation in both artificial light and sunlight.
- Very high abrasion resistance provides long glove service life.
- White Hypalon surface will not hide contamination and is easily cleaned (important for “clean” applications, such as in the pharmaceutical industry).
- Natural soft feel for greater worker comfort.
- Solvent based, multi-dip manufacturing process provides multiple layers of polymer (like a glove within a glove) which results in a glove of superior quality.
- Good tensile strength provides resistance to accidental tears.
- Ambidextrous and hand specific styles available.
- For use with short glovebox gloves.



订货号 Ref.	产品 Product	尺码 Sizes	长度 Length	厚度 Thickness	袖口直径
YSL2027	Hypalon® 护袖	均码	68 厘米	0.5 毫米	254 毫米

丁腈干箱手套

NITRILE GLOVEBOX GLOVES

主要应用：用于制药，防御，核电，生物技术，半导体和制造业中的干箱操作。

- 连体设计比丁腈手套+护袖组合更加安全舒适
- 诺斯独有的丁腈配方不仅提供了较高的抗化学品能力和机械防护性能，而且带给使用者独特的舒适体验
- 丁腈提供了对更大范围的化学品的防护，包括酸、碱、醇、酯和溶剂等
- 机械性强，具有很好的对磨损、刺穿、切割、撕裂等机械危险都有很好的抵抗能力
- 没有比丁腈干箱手套更舒适的干箱手套了。它们不但质量轻(轻的手套不到同类手套质量的30%)，而且有一种独特、柔软、富有弹性的触感
- 大大减少了手部疲劳，提供了工人效率和生产能力
- 可用于用醇类进行清洗的作业。不会降解或变滑
- 抓握面有纹理，不论干湿物品，抓握更加安全
- 固有表面电阻1011Ω/sq，可以有效防止静电累积，在需要防范静电累积的场合使用更加安全
- 符合USDA、FDA和21CFR的要求，可以用于食品加工
- 左右手可互换
- One piece design is more convenient and safer than nitrile glove-and-sleeve assemblies.
- Proprietary North nitrile formulation offers a great combination of chemical resistance, mechanical protection and wearer comfort.
- Nitrile provides good protection from a broad range of chemicals, including acids, bases, alcohols, esters and solvents.
- It is also mechanically robust with good abrasion, puncture, cut and snag resistance.
- No other glovebox gloves offer greater wearer comfort than Nitril-Box. They are light in weight (up to 30% lighter than comparable gloves) and have a unique, soft and flexible feel.
- Hand fatigue is dramatically reduced and worker efficiency and productivity is maximized.
- Compatible with alcohol cleaning practices. Will not degrade or become slippery.
- Textured grip provides safer grip of both wet and dry objects
- Inherently anti-static - surface resistance is 1011 Ω/sq providing safer working where electro-static build-up is a concern.
- Complies with USDA and FDA regulations, 21 CFR, for use in food processing.
- Ambidextrous.



订货号 Ref.	产品 Product	尺码 Sizes	长度 Length	厚度 Thickness	袖口直径
8LA1832A	丁腈干箱手套，左右手可互换	9Q	81 厘米	0.5 毫米	203.2 毫米
10LA1832A	丁腈干箱手套，左右手可互换	10H	81 厘米	0.5 毫米	254 毫米



避火服	Fire Protective Clothing	117
隔热服	Heat Resistant Clothing	119
重型防化服	Chemical Protective Clothing - Heavy	121
中型防化服	Chemical Protective Clothing - Medium	123
轻型防化服	Chemical Protective Clothing - Light	125
喷砂/焊接防护服	Leather Coverall	127
核污染防护服	Nuclear Protective Clothing	128

防护服的尺码选择

Choosing the Right Size

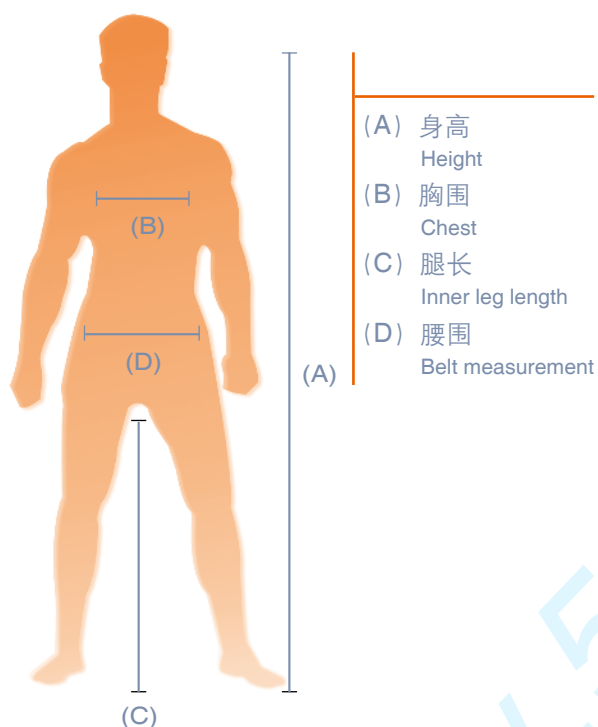

Spacel Plus 3000 RA/EBJ

尺码 Size	身高 Height(A)	腿长 Inner leg(C)
S	164-176	80
M	170-176	80
L	176-182	85
XL	182-188	90
XXL	188-194	97

镀铝隔热上衣下装

Aluminized heat resistant jacket and pants

尺码 Size	身高 Height(A)	胸围 Chest (B)	腿长 Inner leg(C)
S	140-152	84-92	80
M	152-164	92-100	80
L	164-176	100-108	85
XL	176-188	108-116	90
XXL	188-200	116-124	97

了解使用者的需求，结合先进的技术，我们为客户提供一系列的防护服。

防护服装

为多种工作环境中的工人提供具有防护作用的工作服装，为了满足不同用途的需要，我们根据产品的性质和保护水平为客户提供以下五个系列的产品。

防护服相关标准

EN 1486 消防员避火隔热保护

GA 10: 消防员灭火防护服标准

EN 1149-1: 防静电保护

EN 13034: 防化学飞溅物

EN 374: 化学危害

EN 374-2: 细菌污染

EN 368: 防化保护

EN 531: 隔热防火焰保护

EN 943-1: 防护服，防液体与气体化学物质包括液体烟雾和固体颗粒等-第1部分：通风与非通风的不透气的化学防护服的性能要求

EN943-2: 符合应急救援Emergency Teams (ET)化学防护服的绩效要求



订货号 Ref.: 4102334-42-P

B1 PU 避火隔热服

B1 PU Fire Protective Clothing

- 高性能的避火隔热服，可抵御1000°C的火焰，并能够有效防护高温水蒸汽的喷溅，该产品适合近火源使用，但不适合进入或穿越火源
- Aramidic复合材料，全身式防护服
- 外覆铝质保护层，服装前部拉链带有保护翻边和按扣
- 可分离式头罩，头部为镀金玻璃面窗
- 内置安全头盔，带呼吸器背囊。可以配合自给正压式呼吸器使用
- 整体产品包括五指手套及防护靴，整体重量小于10.5公斤
- Five layers one-piece steam-proof fire protective clothing designed for fire approaching in environment up to 1000°C, not suitable to enter or cross a fire
- Full body protective suit made of aluminized fabric based on Aramidic fiber
- Inner safety helmet with a panoramic visor made of gold-coated and replaceable glass included in the hood
- Equipped with an inside back pocket for SCBA, the use of which is highly recommended
- Hood, gloves and shoes included
- Total weight less than: 10.5 kg



订货号 Ref.: 4111839-S-P
4111839-M-P

B2 避火隔热服

B2 Fire Protective Clothing

- 高性能的避火隔热服，可进入1000°C的火场使用
- Aramidic复合材料，连体式防护服
- 共七层，外覆铝质保护层
- 内置安全头盔，镀金玻璃面窗
- 后置背囊，可内置空气呼吸器
- 整体重量小于13.5公斤
- Seven layers one-piece steam-proof fire protective clothing designed for fire approaching in environment up to 1000°C, suitable to enter into fire for emergency
- Full body protective suit made of aluminized fabric based on Aramidic fiber
- Inner safety helmet with a panoramic visor made of gold-coated and replaceable glass included in the hood
- Equipped with an inside back pocket for SCBA, the use of which is highly recommended
- Hood, gloves and shoes included
- Total weight less than: 13.5 kg



订货号 Ref.: 4111831-P

AIR PLUME 避火隔热服 AIR PLUME Fire Protective Clothing

- 高性能的避火隔热服，可抵御1000°C的火焰，并能够有效防护高温水蒸汽的喷溅，该产品适合近火源使用，但不适合进入或穿越火源
- Aramidic复合材料，分体式防护服
- 共三层,厚度4毫米，外覆防火材料和铝质保护层
- 内置安全头盔，镀金玻璃面窗
- 整体产品包括：五指手套及防护靴，重量小于9公斤
- Five layers one-piece steam-proof fire protective clothing designed for fire approaching in environment up to 1000°C, not suitable to enter or cross a fire
- Two-pieces full body protective suit made of aluminized fabric based on Aramidic fiber
- Inner safety helmet with a panoramic visor made of gold-coated and replaceable glass included in the hood
- Equipped with an inside back pocket for SCBA, the use of which is highly recommended
- Hood, gloves and shoes included
- Total weight less than: 9 kg



订货号 Ref.: 14 101 13

镀铝隔热长风衣 Aluminized Heat Resistant Coat

- 产品由镀铝芳香尼龙制成，能够有效防护接触热和对流热，辐射热的防护能够达到 1000°C，并能保护人体免受高温液态金属飞溅的威胁
- 产品为长风衣式设计，领口为环型设计，前襟开口配有快速搭扣和翻边，保证穿着的舒适和使用的安全
- 适用于钢铁制造、冶金及锻造行业
- Long coat with fast fibulae which makes it more comfortable and easy to use
- Designed to protect wearers from the accidental contact with flame, convective and radiant heat and splashes of molten metal
- Radiation heat resistant up to 1000 °C
- Suitable for steel, metallurgy and smithing industry



订货号 1410F34.048 上衣 S 号
Ref. : 1410F34.052 上衣 M 号
1410F34.056 上衣 L 号
1410F34.060 上衣 XL 号

1410F35.048 下装 S 号
1410F35.052 下装 M 号
1410F35.056 下装 L 号
1410F35.060 下装 XL 号

镀铝隔热上衣下装 Aluminized Heat Resistant Jacket And Pants

- 产品由镀铝芳香尼龙制成，能够有效防护接触热和对流热，辐射热的防护能够达到 1000°C，并能保护人体免受高温液态金属飞溅的威胁
- 产品为分体式设计，上衣领口为环型设计，前襟开口配有快速搭扣，下装配有背带，保证穿着的舒适和使用的安全
- 适用于钢铁制造、冶金及锻造行业
- Two-piece (jacket and a pants) clothing with fast fibulae which makes it more comfortable to use
- Designed to protect the wearers from accident contacts with flame, convective and radiant heat and splashes of molten metal
- Radiation heat resistant up to 1000 °C
- Suitable for steel, metallurgy and smithing industry



订货号 Ref.: 14 101 55

镀铝隔热头罩 Aluminized Heat Resistant Helmet

- 产品由镀铝材料制成，并配有镀金压膜面屏，能够有效防护接触热和对流热，辐射热的防护能够达到1000°C，并能保护使用者头部免受高温液态金属飞溅的威胁
- 该产品主要用来配合镀铝隔热服使用，尤其适用在离热源很近和有高温固体或液体飞溅的危险场所
- 适用于钢铁制造、冶金及锻造行业
- The hood has panoramic visor made of gold-coated and replaceable glass
- Designed to work with Aluminized clothing, which protects wearers from accidental contact with flame, convective and radiant heat and splashes of molten metal
- Radiation heat resistant up to 1000°C
- Suitable for steel, metallurgy and smithing industry



订货号 Ref.: 14 100 03

镀铝隔热鞋罩 Aluminized Heat Resistant Shoes Cover

- 产品由镀铝材料制成，能够有效防护接触热和对流热，辐射热的防护能够达到1000°C
- 该产品主要用来配合镀铝隔热服使用
- 适用于钢铁制造、冶金及锻造行业
- Designed to work with Aluminized clothing, this product protects wearers from accidental contact with flame, convective and radiant heat and splashes of molten metal
- Radiation heat resistant up to 1000°C
- Suitable for steel, metallurgy and smithing industry

重型防化服

Chemical Protective Clothing - Heavy



可防护有毒气体、酸性溶剂、
高温液体

Designed to protect
poisonous gas, acid solution
and high temperature liquid



EasyChem 外置式重型防化服

EasyChem Heavy chemical protective clothing
with SCBA outside

- 高性能的气密性防化服，防护性能达到欧标一级的 高防护标准
- 机械强度高，配有高密闭性防水拉链以及拉链保护层
- 服装内外层均带有特殊阻燃涂层，缝合采用高频焊接技术，服装更加耐用，舒适，安全
- 全球独有的单向磁力阀，气体逆向零泄露的同时，持续排除多余的热能，穿着舒适
- 呼吸面罩（斯博瑞安PANO面罩，符合EN-136 Class 3标准）固定在头罩上，丁基橡胶手套可以通过特殊的紧固卡环装卸
- Air-tight chemical protective clothing in accordance with Type one in European standard
- Resistant and durable by high frequency welding
- Comfortable respiratory mask (Sperian panoramasque class 3 and compliant with EN-136 standard)
- Zip fastener waterproof protected by a flap from crotch to head
- Two single magnetic patented exhaust valves: one located on the breast and one on the top of the head

订货号 Ref	服装尺寸 CM Size CM			鞋码 boots
	高度 Height	腰围 Waist	胸围 Chest	
1400020-S-40	165-175	68-72	74-140	40
1400020-M-42	175-185	72-76	74-140	42
1400020-M-44				44
1400020-L-44	185-195	76-80	74-140	44
1400020-XL-44	195+	80+	74-140	44

EasyChem 内置式重型防化服

EasyChem Heavy chemical protective clothing
with SCBA inside

- 高性能的气密性防化服，防护性能达到欧标一级的最高防护标准
- 机械强度高，配有高密闭性防水拉链以及拉链保护层
- 服装内外层均带有特殊阻燃涂层，缝合采用高频焊接技术，服装更加耐用，舒适，安全
- 全球独有的单向磁力阀，气体逆向零泄露的同时，持续排除多余的热能，穿着舒适。
- 采用厚度达2毫米的 宽防护屏，能提供对外界物体冲击的有效防护。
- 头部空间很大，穿戴者可戴头盔后无阻碍的上下左右移动头部，以提供最好的视野。
- Air-tight chemical protective clothing in accordance with Type one in European standard
- Resistant and durable by high frequency welding
- Comfortable shield compliant with EN-136 standard
- Zip fastener waterproof protected by a flap from crotch to head
- Two single magnetic patented exhaust valves: one located on the breast and one on the top of the head



订货号 Ref	服装尺寸 CM Size CM			鞋码 boots
	高度 Height	腰围 Waist	胸围 Chest	
1400021-S-40	165-175	68-72	74-140	40
1400021-M-42	175-185	72-76	74-140	42
1400021-M-44				44
1400021-L-44	185-195	76-80	74-140	44
1400021-XL-44	195+	80+	74-140	44



TYPE 1



氟橡胶/丁基橡胶气密型化学防护服 RINBA® Defender, Gas Tight Chemical Protective Suit

- RINBA®DEFENDER气密型化学防护服符合EN943-1欧洲化学防护服一级气密型防护标准及欧洲EN 943-2: ET应急救援组标准要求，柔软、有弹性、耐用的氟化橡胶材料对有害化学品（特别是芳香族化合物）有很好的防护性能。
- Chemical protective suit RINBA® Defender, SCBA inside (not supplied)
Meets EN943-1 TYPE 1 and EN 943-2 ET
Material: Comfortable, flexible coated polyamide with Butyl on both sides and a additional layer of Viton on the outside.
Visor: 2 mm Poly carbonate with anti fog and anti mist coating
Zipper: Long Neoprene coated gas tight zipper, with the teething on the outside. The zipper is protected by an external splash cover.
Gloves: Separate semi-attached liquid proof glove made from a PVA over neoprene rubber with a cotton liner.
Boots: The suit is supplied with fixed nitrile rubber S5 safety boots in accordance with EN 345-2.

型号	说明
A145110	SCBA(需另外采购)；气密型拉链，齿外面有封盖；易于更换的重型防化手套；丁腈橡胶安全靴；尺码：L / XL



TYPE 1



氯丁橡胶气密型化学防护服 RINBA® Patrol, Gas Tight Chemical Protective Suit

- RINBA®PATROL气密型化学防护服符合EN943-1欧洲化学防护服一级气密型防护标准，氯丁橡胶对多种不同化学物质都具有优越的防护性能。
- Chemical protective suit RINBA® Patrol, SCBA outside (not supplied)
Meets EN943-1 TYPE1
Material: Double coated Neoprene
Face seal: Gas proof elastic foam rubber
Zip: 110cm gastight, gas tight zipper with toothing on inside
Gloves: Nitrile rubber gloves on unique exchangeable adapter
Boots: Sealed Nitrile rubber safety boots

型号	说明
A140340	SCBA(需另外采购)，110厘米气密型拉链，可更换的丁腈橡胶手套，密封丁腈橡胶安全靴，尺码：L/ XL

中型防化服

Chemical Protective Clothing - Medium



喷雾致密型和液体致密型一体式防护服 RINBA® Guardian Plus, Liquid/Spray Tight Chemical Protective Suit

- 符合EN14605欧洲化学防护服第三级液体致密型防护标准
- 优质的氯丁橡胶材质适用于中高浓度化学物质环境中穿着，具有优异的柔韧性。冷热环境下适用性良好
- 胸前液密型楔形拉链更便于穿脱
- Meets EN14605 TYPE 3
- RINBA® Guardian Plus is made from a soft and pliable Neoprene and have been specially developed for situations where wearers in heavy conditions are exposed to high concentrations of chemicals and feel comfortable in both cold and extremely hot conditions.
- Easy to put on and off by means of wedge-shaped closure with zipper and Velcro.

型号	说明
----	----

A164223	带有适合全面具的头罩，手套适配器，氯丁橡胶手套，颜色：黄色/灰色，尺码：M-XL
---------	--

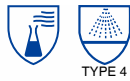

喷雾致密型化学防护服 RINBA® FERRANYL, Spray Tight Chemical Protective Suit

- 符合EN14605欧洲化学防护服第四级喷雾致密型防护标准
- Ferranyl材质比一般PVC材质更加柔韧；同时接缝处使用高频焊接，提供更安心的防护
- 在多种不同化学环境中表现出良好的化学物质性防护性能和防化学品渗透性能
- Meets EN14605 TYPE4
- Ferranyl is characterised for its good chemical resistance and permeation in a wide variety of chemical applications. Furthermore it is much more flexible than ordinary PVC's.
- The seams of the chemical protective clothing are stitched and high frequency welded for excellent protection against spray's.
- The sleeves, aprons, jackets and trousers are approved in accordance with EN14605 for protection of specific body parts against chemical substances.

型号	说明
----	----

A163332	背带裤，带调节带，灰色。尺码：M-XL
A163731	上衣，无头罩，带覆盖式拉链和尼龙粘扣，深红色，尺码：M-XL
A164856	围裙，带调节带，70x120cm，深红色。
A164141	带袖围裙，70x120cm，灰色和深红色。

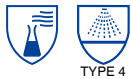

TYPE 4



喷雾致密型化学防护服 Boiler Suit

- 绿色PVC 带衬化学防护服。符合EN14605 欧洲化学防护服四级喷雾致密型防护标准。接缝为缝线和超声波焊接，加强了防护效果。具有超强的耐磨性能。可有效防酸、碱和其他化学物质。
- PVC coated suit all seams are sewn and welded. With chemical tight plastic zipper and metal press studs for perfect protection against (chemical) liquids.

型号	说明
N71254110	尺码: M
N71254210	尺码: L



通用PVC一体式防护服 RINBA® Splash, Liquid Tight Coverall Splash

- 符合欧洲EN343防护服标准
- 加厚的弹性PVC材料保证安全防护，舒适穿着
- 配有安全靴、手套和头罩
- 弹性头罩可为用户的面部和颈部提供全面的防护
- 胸部以下防水，推荐如在下水道和液体肥料槽中等接触大量液体的繁重劳动时穿着
- Meets EN343
- One piece suit complete with boots, gloves and hood for extra safety.
- Heavy duty, stretch PVC material for safe and comfortable wear.
- Elastic hood for proper sealing of wearer's face and neck.
- Liquid tight up to the chest. Ideal for rough work in sewers and liquid manure tanks.

型号	说明
A164380	尺码: M-XXL



TYPE 3

TYPE 4



SPACEL PLUS 3000 RA/EBJ

- 多层复合聚乙烯防护服
- 厚度100微米
- 外表面黄色 内表面白色
- 防护服为连体带风帽设计
- 手腕和脚踝处装有松紧带
- 拉链设计，并在门襟处采用粘着性翻盖保护
- 尺码: M-XL
- 3-layered Polyethylene coveralls, with yellow outer layer and white inner layer
- Elastic back and adhesive flap
- Thickness: 100u

订货号 41 801 49-03 M
Ref. : 41 801 49-04 L
41 801 49-05 XL



用途：汽车油漆，制药工业，危险化学品操作，工业清扫，食品加工.....

This product is designed for printing, hygiene, chemical protective, cleaning, food and pharmacy industry



DS200 系列一次性防护服

- 一次性使用的防静电防护服
- 符合防护服欧洲标准
- 第五类 (EN 13982-1) - 对有害的干燥微粒起到防护作用
- 第六类 (EN 13034) 对化学液体的轻度喷溅起到防护作用
- 符合欧洲 M1 织物阻燃标准 (EN533 / NFP92507)
- 达到 EN 1149 防静电标准
- 达到 EN1073-2: 2002 防放射性微粒穿透标准的要求
- 60g 白色四层复合聚丙烯面料
- 面料材质柔软，穿着舒适并具有卓越的透气性能
- 双层拉链和脚踝及手腕处有松紧带的设计，有效防止液体进入，具有良好的密封性
- 胳膊与肩膀处无缝连接，穿着合体，舒适，回弹性好
- 尺寸：M-XXXXL
- EN1149, anti-static
- EN 533 and M1 certified/ no ignition
- Protect against radioactive particles EN 1073-2: 2002
- 4 layered, non-woven white polypropylene, 60g/m²
- Extraordinary breathability
- Double protective flap (inner/outer)
- Double zipper
- Size : M-XXXXL

产品名称 Product name	订货号 Ref	产品描述 Description		应用行业 Application
		视窗 window	兜帽 hood	
DS201	AP4571450	无 no	有yes	所有行业 Mass industries
DS202	941001	有yes	无no	核工业 Nuclear
DS203	941002	有yes	有yes	

尺寸 (size)	M	L	XL	XXL	XXXL	XXXXL
胸围(cm) Chest (cm)	84-92	92-100	100-108	108-116	116-124	>124
身高 (cm) Height (cm)	164-170	170-176	176-182	182-188	188-194	>194



订货号 Ref.: 45 714 33

MS 3.5.6

- 一次性使用的防静电防护服
- 55g白色多层复合聚丙烯防护服
- 出于舒适性考虑，裁剪宽大
- 防护服为连体带风帽设计
- 手臂和脚踝处有松紧带
- 拉链有双重翻盖的保护直到下巴
- 尺寸：M-XL
- 3-layered, non-woven white polypropylene, 55g/m²
- EN 1149, Antistatic
- Elastic back, double slider and no seams on shoulders



EN 465



TYPE 6

TYPE 5



抛弃型连体防护服

- 抛弃型连体防护服均符合欧洲化学防护服第五、六级粉尘及有限喷溅型防护标准
- GEN“**AIR**”采用柔软透气的创新材料制造。可以针对有毒粉尘和液体喷溅提供卓越防护。含绒毛量低，因此可以特别适合在使用者需要保护，而又不允许衣服的毛绒污染所在的环境时使用
- GEN“**PRO**”采用独特的非机织纤维混合材料制造，可以有效地防护有毒粉尘和液体喷溅
- The GEN AIR coverall is constructed from a new generation of laminated Micro-porous fabric that complies with CE Type 5 & 6 protection standards giving it resistance to noxious dust and splash. It combines excellent chemical properties as well as offering high comfort levels due to the light weight and the breathable panels in the hood, under the arm and the gusset made of SMMMS material.
- The GEN PRO coverall is constructed from a revolutionary new blue fabric using SMMMS (spun bound and melt blown polypropylene) technology. It combines excellent chemical and particulate protection, high breathability properties and high comfort Levels. Therefore this product can be worn comfortably for long periods of time and is low linting.

型号	说明
85596	通用“Air”系列抛弃型通风连体防护服，白色，尺码：S-4XL
35596/35596W	通用“Pro”系列抛弃型连体防护服，蓝色/白色，尺码：S-4XL

喷砂/焊接防护服 Leather Coverall



RINBA® 皮质防护服 RINBA® Leather Coverall

- 用于喷砂作业或焊接作业的防护服
- 该款防护服正面为皮质、背面为棉质。
- 手臂部分完全为皮质，袖口为弹力棉质。
- 专门为焊接和喷砂作业设计。
- 皮质材料可针对火花和喷溅砂粒提供保护。
- 棉质材料可提供降温效果。
- 裤脚褶边样式，带有金属铆扣。
- Typical Application: SBS & welding
- Fully leather arms with elastic cotton cuffs
- Leather protects against sparks and rebounding blast grit
- Cotton back for cooling effect
- Equipped with double turn-up with jeans buttons

Rinba 皮质防护服技术说明

型号	A164450
尺寸	L
防护服材料	皮质和棉布
套袖材料	皮质
裤脚	裤脚褶边（带金属铆扣）

核污染防护服 Nuclear Protective Clothing



订货号 Ref.: 85 273 39

通风头罩 Ventilated Helmet

- 由防火PVC材料制成，能有效防护放射性粉尘、放射性气溶胶等放射性污染物对呼吸系统的危害。带有披肩，充气式领口，需与7~8巴中压供气系统和DE4组合使用
- Disposable fireproof PVC hood, designed to isolate the wearer's respiratory tract when working in surrounding with presumed or known particle contamination
- To be used in conjunction with middle pressure air-supply system



订货号 44 812 11 - 01 S
Ref. : 44 812 12 - 02 M
44 812 13 - 03 L
44 812 14 - 04 XL

通风气衣 Ventilated Clothing

- 用防火的PVC材料制成，拉链在背部开合。带有流量调节器和2个单向排气阀，能有效防护放射性粉尘、放射性气溶胶等放射性污染物对呼吸系统及人体体表的危害。需与7~8巴中压供气系统和DE4组合使用
- Disposable fireproof PVC suit, designed to isolate the wearer's respiratory tracts and body when working in surrounding with presumed or known particle contamination
- Excellent protection faction (>100,000)
- To be used in conjunction with middle pressure air-supply system

材料物性及防化性能参考表

**注意：部分材料防化性能表，仅供参考。具体选型需根据实际使用场合、环境及所接触化学品形态及浓度等各方面因素综合考量。

Overview Coated fabric properties					
Properties	Standard	Ferranyl	Neoprene	Butyl	Viton
Outside colour		Red/grey	yellow/grey	green	dark yellow
Total weight		360 g/m ²	370 g/m ²	720 g/m ²	600 g/m ²
Temperature range		-30°C / +70°C	-30°C / +70°C	-30°C / +70°C	-30°C / +70°C
Abrasion resistance	EN 530-2	6	6	6	6
Stability to heat	EN 25978	2	2	Pass	Pass
Bending resistance	ISO 7854-B	5	5	5	5
Puncture resistance	EN 863	2	2	2	2
Tear resistance	ISO 4674-A	5	3	5	5
Seam strenght	ISO 5082	4	5	4	4

Chemical	Ferranyl	Neoprene	Butyl	Viton
A				
Acetaldehyde	C	C	A	C
Acethylene	C	B	A	C
Acetic acid, glacial	C	B	B	C
Acetic acid 100%	C	B	B	C
Acetic acid 30%	B	A	A	B
Acetic acid 85%	C	B	B	C
Acetic acid anhydride	C	B	A	C
Acetone	C	C	A	C
Acetonitrile	C	C	A	C
Acrolein			A	C
Acrylonitrile	C	B	B	C
Alcoholic beverages	B	A	A	A
Allyl alcohol	C	C	A	A
Aluminium chloride	A	A	A	A
Aluminiumsulphate	A	A	A	A
n-Aminoethylpiperazine			A	
Ammonia	B	A		
Ammonia >30%	B	A		B
Ammonia, gaseous	B	A	B	C
Ammonium chloride	A	A	A	A
Ammonium chloride	A	A	A	A
Ammonium sulphate	A	A	A	A
Ammoniumhydroxide	A	A	A	A
normal Amyl acetate	C	C	A	C
normal Amyl alcohol	A	A	B	B
Aniline	C	C	A	A
Asphalt for roads	A	B	C	A
B				
Barium hydroxide	A	A	A	A
Battery acid	A	A	A	A
Benzaldehyde	C	C	A	C
Benzene	C	C	A	C
Benzene	C	C	C	A
Benzonitrile			A	C
Benzotrifluoride	C	C	B	
Benzoyl chloride	C	C	B	B
Benzyl				
Benzyl alcohol	C	B	A	A
Benzyl chloride	B	C	B	
Bleach liquor	A	B	B	B
Borax	A	A	A	A
Boric acid	A	A	A	A
Bromoacetone nitrile			A	A
1-Bromo-2-Propanol			A	A
3-Bromo-1-propanol		A	A	A
1,3-Butadienes	A	B	B	B
Butyraldehyde	B	C	A	C
n-Butane	C	A	C	A
Butyric anhydride	C	B		
n-Butanols	B	A	A	A
para-t-Butyl toluene			C	A
2-Butanone	C	C	A	C
Butyl acetate	C	C	B	C
Butyl ether	C	B	B	
Butyl ether	C	B	B	
C				
Calcium sulphate	A	A	A	A
Calcium bisulfide	A	A	B	A
Calcium chloride	A	A	A	A
Calcium hydroxide	A	A	A	B
Calcium hypochlorite	A	C	A	A
Carbolic acid	C	A	A	A
Carbolic acid / Phenol	C	A	A	A
Carbon dioxide	A	A	A	A
Carbon disulphide	C	C	C	A
Carbon monoxide	A	A	A	A
Caustic soda	B	A	A	B
Chlorine	B	A	C	B
Chlorine bleach water	A	A	B	A
Chlorine decolourising agent	A	B	B	A
Chlorine, liquid	B	C	C	A
Chloroacetonitril			A	A

Chemical	Ferranyl	Neoprene	Butyl	Viton
Chloroform	C	C	C	A
1-Chloronaphtalene	C	C	C	
2-Chloroprene	C	C		
1-Chloro-2-Propanol	C		A	A
3-Chloro-1-Propanol	C		A	A
Chlorosulphonic acid	C	C	C	C
Chlorosulphonic acid	C	C	C	C
Chlorothene	C	C	C	A
Chromic acid	A	C	C	A
Citric acid	A	A	A	A
Copper-ii-Sulfate	A	A	B	A
Creosote oil	B	A	A	
ortho-Cresols	C	B		
Crotonaldehyde		C	A	C
Crude oil, petroleum		C	B	A
Cyclohexanol	B	B		A
Cyclohexane	C	C	C	A
Cyclohexanone	C	C	B	C
D				
Diacetone alcohol		A	A	A
Dibuthylphthalate	A	A	A	B
1,4-Dichloro-2-Butene	C	C	A	A
Dichlorodifluoromethane	C	C	A	B
Dichlorodifluoromethane Freon 11	C	B	B	B
Dichlorodifluoromethane Freon 12	C	A	A	B
Dichlorodifluoromethane Freon 113TF	C	B	C	B
Dichlorodifluoromethane Freon 114	C	A	A	A
Diesel fuel	C	A	C	A
Diethyl glycol	C	A	C	A
1,1-Difluoroethelene		A	A	A
n,n Dimethyl acetamide	C	C	A	C
Diisobutyl ketone	C	C	B	C
1,2-Dichloroethane	C	C	C	A
Diocetylphthalate	C	C	A	C
Dioxane	C	C	A	C
1,4-Divinylbenzene	C	C	A	C
E				
Epichlorohydrin	C	C	A	C
Ethanol	B	A	A	A
Ethanolamine	B	A		
Ether	C	C	C	C
Ethyl acetate	C	C	A	C
Ethyl bromide	C	C	B	A
Ethyl chloride	C	B	C	A
Ethyl glycol	C	B	B	B
Ethyl methyl ketone	C	C	A	C
Ethylamine	C	C	A	C
Ethylene dibromide	C	C	C	A
Ethylene glycol	A	A	B	A
Ethylene Glycol Mono Butyl Ether	A	B	A	A
Ethylene Oxide	C	C	B	C
2-Ethyl hexane acid	A	A		
F				
Formaldehyde	B	A	A	A
Formalin	B	A	A	A
Formic acid	A	A	A	B
Fuel	B	B	C	A
Fural	A	B	A	C
Furfurale	A	B	A	C
Freon TMC	C	C		
G				
Gas / Petrol	C	B	C	A
Gas, Petrol	C		C	A
Gasoil	C	A	C	A
Gasoline / Motor spirit	C	B	C	A
Glucose	A	A	A	A
Glycerin	B	A	A	A
Glycerol	B	A	A	A
Glycol	A	A	B	A
H				
Heating oil	B	B	C	A
Heptane	C	A	C	A
Hexamethyl phosphoramide			B	
normal-Hexane	C	A	C	A

A = very good/suitable B = good/average suitability C = not suitable

Chemical	Ferranyl	Neoprene	Butyl	Viton
Hydraulic oil	A	C	C	A
Hydrazine 100%	C	C	A	C
Hydrazine 30-70%	A	A	A	A
Hydrochloric acid 36%	A	A	A	B
Hydrochloric acid 15%	A	A	A	B
Hydrochloric acid 36%	A	A	A	B
Hydrogen	A	A	A	A
Hydrogen chloride 15%	A	A	A	B
Hydrogen chloride 36%	A	A	A	B
Hydrogen cyanide	A	B	A	A
Hydrogen cyanide	B	B	A	B
Hydrogen Fluoride 30-80%	C	B	B	B
Hydrogen Fluoride, gaseous	A	B	C	B
Hydrogen peroxide 50%	A	B	A	A
Hydrogen sulphide	A	B	A	B
Hydroquinone	A	A		
I				
beta-Ions			A	A
Isoamyl acetate	C	C		
Isoamyl nitril		C		C
Isobutyl alcohol	C	A		
Isooctane	C	C	B	A
Isoprene		C		C
Isopropyl acetate	C	C	A	A
Isopropyl alcohol	C	C		C
K				
Kerosene	C	B	C	A
L				
l-D-Lactid acid	A	A	A	B
lubricant oil		B	C	A
M				
Magnesium chloride	A	A	A	A
Magnesium hydroxide	A	A	A	A
Maleic acid	A	A	B	A
MCP	A			
MEK	C	C	A	C
Mercuric chloride	A	A	A	A
Mercury	A	A	A	A
meta-Xylene	C	C	C	A
Methane sulfonic acid		A		
Methanol	C	B	B	B
Methanol	C	B	B	B
4-Methoxy-4-methyl-2-Pentanone		C	A	C
Methyl acetate	C	C	B	C
Methyl alcohol	C	B	B	B
Methyl amine	A	A	B	
Methyl chloride	C	C	B	B
2-Methyl-4-Chlorophenoxyacetic acid	A			
Methyl chloroform	C	C	C	A
Methyl glycol			A	
Methyl iodide	C	C		
Methyl isobutylketone	C	C	B	
Methyl methacrylate	C	C	B	
Methylene chloride	C	C	C	B
Mineral oil	A	A	C	A
Monobromobenzene			C	A
Monochlorobenzene	C	C	C	A
Morpholine	C	C	A	C
N				
Naftalene	B	C	C	A
Naphta <3% arom. 150-200°C	C	B	C	
Naphta <3% arom. 180-260°C		B		
Naphta 10-15% arom. 120-140°C	C	B		
Naphta 15-20% arom. 150-200°C	C	B		
Naphta 15-20% arom. 180-260°C	A	A		
Sodium chloride	A	A	A	A
Nitric acid 10%	A	A	B	A
Nitric acid 30%	A	A	B	A
Nitric acid 60%	B	B	C	A
Nitrobenzene	C	C	B	A
Nitrohydrochloric acid	B	B		
Nitromethane / Nitrocarbol	C	C		
1-Nitropropane	C	C	A	C
2-Nitropropane			B	
Nonyl phenol	A			
O				
Octane	C			
Oleic acid	B	B		B
Oleum 20% SO3	C	C	C	A
Oleum 65% SO3	C	C	C	A
Oxalic acid	A	A		
P				
Paint- solvents	C	C	C	A
Palmitic acid	B	A	B	A
PCB	C	A	A	A
Pentachlorophenol	B	C		A
normal-Pentane	C	C		A
Perchloric acid 50-72%	A	A		

A = very good/suitable B = good/average suitability C = not suitable

Chemical	Ferranyl	Neoprene	Butyl	Viton
Perchloric ethylene	C	C		
Petrol		C		
Petroleum	C	B	C	B
Phenol	C	A	A	A
0-p-Phenolsulphonic Acid		A		
Phosphoric acid 100%	A	A		
Phosphoric Acid 25-85%	A	A	A	A
Phosphorus Oxchloride	C	C		C
Picric acid	C	B	B	A
Polychlorinated biphenyls	C	A	A	A
Potassium bromide	A	A	A	A
Potassium cyanide	A	A	A	A
Potassium dichromate	A	B	A	A
Potassium hydroxide	A	A	A	A
Potassium hydroxide	A	A	A	A
Potassium nitrate	A	A	A	A
Potassium nitrate	A	A	A	A
Potassium sulphate	A	A	A	C
n-Propanol	B	A	A	A
β-Propiolacton				
Propionaldehyde		C	A	C
Propionitrile	C		C	
Propyl acetate	C	C	B	C
Propylene oxide	A	A	A	A
Pyridine	C	C	B	C
S				
Soap solutions	A	A	A	A
Sodium acetate	C	A	A	A
Sodium carbonate 70%	A	B	B	B
Sodium chloride	A	A	A	A
Sodium dichromate		B	A	A
Sodium fluoride	A	A	A	A
Sodium hydroxide	B	A	A	B
Sodium nitrate	A	B	A	A
Sodium peroxide		B	A	A
Sodium sulphate	A	A	A	A
Soybeanoil	A	A	A	A
Special boiling point spirit		B	C	
Stearic acid	A	B	B	A
Styrene	C	C	C	A
Sulphur	C	B	C	A
Sulphur dioxide acid	C	C	B	A
Sulphur dioxide, gaseous	A	B	C	A
Sulphur trioxide		C	B	A
Sulphuric acid 25%	A	A	A	A
Sulphuric acid 50%	A	B	A	A
Sulphuric acid apr. 98%	B	C	C	B
Sulphuric acid fuming 20%	C	C	C	A
Sulphuric acid, fuming 65%	C	C	C	A
Sulphurous acid	C	C	B	A
T				
Tannic acid	A	A		A
Tars			C	A
Tetra	C	C	C	A
1,1,2,2-Tetrachloroethane	C	C		
Tetrachloromethane	C	C	C	A
Tetrafluoroethylene		A	A	A
Tetrahydrofuran	C	C	C	C
Toluene	C	C	C	A
2,4-Tolunene diisocyanate	C	C	A	A
para-Toluenesulphonic acid	A	A		
Tribromoethane			A	A
Tributyl phosphate		C	B	C
1,1,2-Trichloroethane		C	C	A
Trichloro acetonitrile		C	C	C
Trichloro ethylene	C	C	C	A
Trichloro ethylene	C	C	C	A
1,2,3-Trichloropropane			A	A
Trichloromonofluoromethane	C	B	B	B
Trichloromethane	C	C	C	A
Tricresyl phosphate	A	C	A	A
Triethanolamine	A	A	B	C
Trifluoric ethanol	C	B		
Turpentine	C	C	C	B
Turpentine / White spirit	C	B	C	
V				
Vinyl chloride				A
W				
Water	A	A	A	A
White spirit	C	B	C	
X				
Xylene	C	C	C	A
Z				
Zinc chloride	A	A	A	A



工业用安全鞋	Industry Safety Shoes	133
安全防护靴	Safety Boots	137
工矿靴	Heavy Duty Boots	140
电力伤害防护靴	EH Protection	140
防寒靴	Cold Resistance	141
消防战斗靴	Fire Fighter	142



为了使每个人都能拥有一双合适的安全鞋，霍尼韦尔在结合高新科技的基础上，不断地推陈出新，设计出更符合人体工程学的新款鞋型，穿着更舒适更便捷，具有更高效的保护性。

根据流行趋势，我们的鞋型设计部门推出了能够满足不同类型的使用者的需要的鞋型。我们的设计集简洁和优雅于一身，每一款鞋型都始终考虑其功用性。

- 以其三大系列的特别设计，斯博瑞安集团提供了市场上为齐全的安全鞋鞋型。使用高品质的材料和独一无二的特性，使我们得到了使用者对于其舒适程度一致好评。
- 其使用皮革的多样性和丰富性使我们有能力提供想要的各款鞋型。
- 特殊的鞋款造型，符合脚底曲线的鞋底设计以及多种透气设计法是提供舒适性和安全性的关键。
- 鞋内透气膜的使用确保了在任何气候条件下都能提供大的舒适度。

完美细节保证优异品质 Perfect detail, excellent quality.



足部防护系列

室外鞋

室外鞋系列的适用对象为在恶劣气候和工业危险的场所工作的室外人员。所有鞋款的鞋底都有防滑钉以加强抓地力。

功能鞋

如果使用者的工作环境经常变化，功能鞋系列能极好地满足使用者兼顾舒适-保护-安全的需要。

特殊鞋

某些行业的工作环境特殊或者极端。为了更好地满足这些行业工作者——如电焊工，高炉铸铁工或森林看守者的需要，斯博瑞安集团推出一系列考虑到这些职业的特殊性的鞋款。

工业用安全鞋 Industry Safety Shoes



RIDER经济型轻便安全鞋

- 采用防泼水面料，代替传统牛皮
- 轻便鞋身，比普通安全鞋轻20%左右
- 良好的透气性和舒适性
- 加宽钢包头，适合亚洲人脚型，避免包头夹脚现象
- 户外安全鞋设计，一改传统安全鞋沉闷，笨重的感觉
- 新一代双密度PU大底，穿着舒适，轻便
- 具有 佳的防滑性能，符合欧洲防滑 高标准SRC
- 符合中国国标
- 中帮，低帮两种款式可选
- 尺码：35-47
- Good combination of leather and water repellent fabric on the upper
- Light weight, about 20% less than traditional safety shoes
- Good breathability and comfortable
- Wider toe cap to fit Asian feet
- Outdoor design in 2011
- New double density PU outsole, complied with SRC standard
- Complied latest GB standard
- Both Low cut and Mid cut styles available
- Size: 35 – 47

订货号 Ref. :
低帮

SP2011300 Rider 防静电
Rider Anti-static
SP2011301 Rider 防静电，保护足趾
Rider Anti-static, Anti-impact
SP2011302 Rider 防静电，保护足趾，防刺穿
Rider Anti-static, Anti-impact, Anti-puncture
SP2011303 Rider 电绝缘
Rider 6000V electrical insulation

中帮

SP2011310 Rider 防静电
Rider Anti-static
SP2011311 Rider 防静电，保护足趾
Rider Anti-static, Anti-impact
SP2011312 Rider 防静电，保护足趾，防刺穿
Rider Anti-static, Anti-impact, Anti-puncture
SP2011313 Rider 电绝缘
Rider 6000V electrical insulation



TRIPPER 轻便安全鞋

- 休闲鞋式样，由法国设计师2010年全新设计，两种颜色可供选择
- 采用翻毛皮加网布加内侧透气孔的鞋帮面设计，有效提高透气性，舒适性
- 使用高品质的吸汗网布内衬，吸汗性强，避免闷脚，臭脚现象
- 轻巧的鞋帮和大底设计，减少鞋身重量，比传统安全鞋重量轻15% 以上
- 选用加宽钢包头，有效减少包头夹脚现象
- 最新一代双密度PU大底，穿着舒适，轻便
- 具有极佳的防滑性能，符合欧洲防滑最高标准SRC
- 符合中国国标
- 尺码 35-47
- Fashionable design in 2010, two colour to be selected
- Breathable design with Suede leather and metal hole on the side
- High quality 3D lining
- Light weight, 15% lighter than traditional safety shoes
- New double density, double colour PU outsole with excellent anti-slip ability, complied with SRC standard
- Wider toe cap to fit Asian feet
- Brand new design double density PU outsole
- Excellent anti-slip outsole, complied with SRC standard
- Complied latest GB standard
- Size: 35-47

订货号 Ref. :
灰色款

SP2010500 Tripper 防静电
Tripper Anti-static
SP2010501 Tripper 防静电，保护足趾
Tripper Anti-static, Anti-impact
SP2010502 Tripper 防静电，保护足趾，防刺穿
Tripper Anti-static, Anti-impact, Anti-puncture
SP2010503 Tripper 电绝缘
Tripper 6000V electrical insulation

红色款

SP2010510 Tripper 防静电
Tripper Anti-static
SP2010511 Tripper 防静电，保护足趾
Tripper Anti-static, Anti-impact
SP2010512 Tripper 防静电，保护足趾，防刺穿
Tripper Anti-static, Anti-impact, Anti-puncture
SP2010513 Tripper 电绝缘
Tripper 6000V electrical insulation

Lancer 非金属轻便安全鞋



订货号 Ref. :

灰色款

SP2010901 Lancer 防静电, 保护足趾

Lancer Anti-static, Anti-impact

SP2010902 Lancer防静电, 保护足趾, 防刺穿

Lancer Anti-static, Anti-impact, Anti-puncture

SP2010903 Lancer电绝缘, 保护足趾

Lancer anti-impact, 6000V electrical insulation

米色款

SP2010911 Lancer 防静电, 保护足趾

Lancer Anti-static, Anti-impact

SP2010912 Lancer防静电, 保护足趾, 防刺穿

Lancer Anti-static, Anti-impact, Anti-puncture

SP2010913 Lancer电绝缘, 保护足趾

Lancer anti-impact, 6000V electrical insulation

- 休闲鞋式样, 由法国设计师设计, 与欧洲式样同步, 两种设计可选
- 鞋身整体无任何金属部件, 有效提高安全性
- 采用非金属保护包头(200J) 和防刺穿中底, 无磁性, 可无干扰通过安检门
- 加宽包头, 适合亚洲人脚型, 避免夹脚现象
- 采用打孔翻毛皮(米色款) 或者翻毛皮+透气网布(灰色款) 设计, 有效提高透气性和舒适性
- 使用高品质的吸汗网布内衬, 吸汗性强, 避免闷脚, 臭脚现象
- 轻巧的鞋帮和大底设计, 减少鞋身重量, 比传统安全鞋重量轻25% 以上
- 新一代双密度PU大底, 穿着舒适, 轻便
- 具有 佳的防滑性能, 符合欧洲防滑 高标准SRC
- 符合中国国标
- 尺码 35-47
- Fashionable design in 2010, two colour to be selected
- Metal free upper design
- Non-metal 200J composite toe cap and non-metal midsole
- Non-conductive, non- magnetism
- Breathable design with Suede leather upper
- High quality 3D lining
- Light weight, 25% lighter than traditional safety shoes
- New double density, double colour PU outsole with excellent anti-slip ability, complied with SRC standard
- Wider toe cap to fit Asian feet
- Brand new design double density PU outsole
- Excellent anti-slip outsole, complied with SRC standard
- Complied latest GB standard
- Size: 35-47

ECO 经济型低帮安全鞋



订货号 Ref. :

BC0919701 ECO 防静电, 保护足趾

ECO Anti-static, Anti-impact

BC0919703 ECO 防静电, 保护足趾, 防刺穿

ECO Anti-static, Anti-impact, Anti-puncture

BC0919702 ECO 保护足趾, 电绝缘安全鞋

ECO Anti-impact, 6000V electrical insulation

- 优质进口牛皮鞋面, 皮革厚度1.8毫米至2毫米
- 2010年全新改良, 提高舒适感
 - 采用加宽钢包头, 符合亚洲人脚型, 极大减少钢包头夹脚现象
 - 符合人体工程学脚踝设计, 有效避免后跟磨脚现象
- 去掉金属鞋眼扣, 使之更加安全(特别是电绝缘安全鞋)
- 非封闭鞋舌设计, 提高透气性
- 双密度PU大底, 优异的抓地性, 符合欧洲防滑最高标准 SRC
- 符合最新国标
- 尺码 35 – 47
- High quality imported buffalo leather, thickness from 1.8mm to 2mm
- 2010 brand new modification to improve the comfort
 - Wider toe cap to fit Asian feet
 - Conform to Ergonomics design on ankle parts
- Remove metal eyelet to improve the safety, especially for electrical insulation shoes
- Brand new design double density PU outsole with excellent anti-slip ability, complied with SRC standard
- Complied latest GB standard
- Size: 35-47



订货号 Ref. :

BC6242121 RACING 防静电, 保护足趾
RACING Anti-static, Anti-impact

BC6242122 RACING 防静电, 保护足趾, 防刺穿
RACING Anti-static, Anti-impact, Anti-puncture

BC6242124 RACING 保护足趾, 电绝缘
RACING Anti-impact, 6000V electrical insulation

RACING 低帮安全鞋

- 采用进口高质量防水牛皮, 适用于潮湿, 多油污等恶劣环境
- 2010年全新设计, 整个鞋身为流线型, 更具时尚感
- 全新改良有效提高舒适感
 - 采用加宽钢包头, 符合亚洲人脚型, 极大减少钢包头夹脚现象
 - 符合人体工程学脚踝设计, 有效避免后跟磨脚现象
 - 吸汗网布内衬, 提高吸汗性, 降低闷脚感
- 封闭鞋舌设计, 防止液体飞溅
- 双密度PU大底, 优异的抓地性, 符合欧洲防滑最高标准 SRC
- 符合最新国标
- 尺码 35 – 47
- High quality imported water resistant leather, suitable in wet and oily environment
- 2010 brand new modification to be more fashion and comfortable
 - Wider toe cap to fit Asian feet
 - Conform to Ergonomics design on ankle parts
 - Mesh lining to reduced the humidity inside of shoes
- Bellowed tongue to prevent the liquid
- Brand new design double density PU outsole with excellent anti-slip ability, complied with SRC standard
- Complied latest GB standard
- Size: 35-47



订货号 Ref. :

BC6240225 COLT 防静电 防砸
COLT Anti-static Anti-impact

BC6240226 COLT 防静电 防砸 防刺穿
COLT Anti-static Anti-impact Anti-perforation

BC6245227 COLT 防砸 电绝缘
COLT Anti-impact 6000 Volt electrical insulation

COLT 低帮安全鞋

- 全粒面头层进口牛皮鞋面, 皮革厚度1.8毫米至2毫米
- D型扣, 舒适型全封闭鞋舌, 防止飞溅液体渗透
- 鞋后跟柔软海绵加厚设计, 有效防止磨脚
- 双密度PU大底, 优异的抓地性, 符合欧洲防滑最高标准 SRC
- 符合最新国标
- 尺码 35 – 47
- Indian full grain buffalo leather upper
- D-ring lacing, with a padded bellowed tongue, comfortable collar design
- Wider toe cap to fit Asian feet
- Brand new design double density PU outsole with excellent anti-slip ability, complied with SRC standard
- Comply with GB standard
- Size: 35-47



订货号 Ref. :

BC0828101 GRANT 防静电 防砸
GRANT Anti-static Anti-impact

BC0828102 GRANT 防静电 防砸 防穿刺
猪皮鞋垫
GRANT Anti-static Anti-impact Anti-perforation
leather insole

GRANT 低帮安全鞋

- 全粒面头层进口牛皮鞋面，皮革厚度1.8毫米至2毫米，防水防油
- 双密度聚氨酯 (PU) 注塑鞋底，鞋底特殊防滑设计，耐磨舒适
- D 型扣，舒适型全封闭鞋舌，防止飞溅液体渗透
- MESH排汗透气材质内衬，耐磨透气
- EVA真皮鞋垫，有效吸汗，凉爽柔软
- 防踢鞋头，鞋后跟设计
- 符合中国国标
- 尺码：34-48
- Anti-kick Design of toecap
- Full grain leather upper,durability
- Mesh lining, Breathability
- EVA+Pigskin innersole,soft & breathability
- Anti-static(Q), anti-impact(C),anti-perforation(ST), 6000 Volts electrical insulation(EH)
- A bellowed tongue



订货号 Ref. :

BC6240470 GLOBE防静电，防砸
GLOBE Anti-static, Anti-impact

BC6240471 GLOBE防静电，防砸，防穿刺
GLOBE Anti-static, Anti-impact, Anti-puncture

BC6240475 GLOBE电绝缘，防砸
GLOBE anti-impact, 6000V electrical
insulation

BC6240474 GLOBE防静电，防砸，保暖内衬
GLOBE Anti-static, Anti-impact, Warm lining

BC6240476 GLOBE防静电，防砸，防穿刺，
保暖内衬
GLOBE Anti-static, Anti-impact, Anti-puncture,
Warm lining

BC6240478 GLOBE电绝缘，防砸，保暖内衬
GLOBE anti-impact, 6000V electrical
insulation, Warm lining

GLOBE 中帮安全鞋

- 2010年全新改良，有效提高舒适感
 - 采用加宽钢包头，符合亚洲人脚型，极大减少钢包头夹脚现象
 - 符合人体工程学脚踝设计，有效避免后跟磨脚现象
 - 吸汗网布内衬，提高吸汗性，降低闷脚感
- 封闭鞋舌设计，防止液体飞溅
- 柔软海绵夹层的中帮设计，保护脚踝
- 双密度PU大底，优异的抓地性，符合欧洲防滑最高标准SRC
- 保暖内衬可选
- 符合最新国标
- 尺码 35 – 47
- 2010 brand new modification to improve the comfort
 - Wider toe cap to fit Asian feet
 - Conform to Ergonomics design on ankle parts
 - Mesh lining to reduced the humidity inside of shoes
- Bellowed tongue to prevent the liquid
- Brand new design double density PU outsole with excellent anti-slip ability, complied with SRC standard
- Complied latest GB standard
- Warm lining to be selected
- Size: 35-47

安全防护靴 Safety Boots



RALLYE 安全靴

- 2010年全新设计, 全新改良有效提高舒适感
 - 采用加宽钢包头, 符合亚洲人脚型, 极大减少钢包头夹脚现象
 - 符合人体工程学脚踝设计, 有效避免后跟磨脚现象
 - 吸汗网布内衬, 提高吸汗性, 降低闷脚感
- 采用黑色全粒面头层牛皮, 皮革厚度1.8毫米至2毫米
- 靴筒两侧提耳, 方便穿戴
- 符合人体工程学设计, 有效支撑脚踝, 舒适合脚
- 保暖内衬可选
- 双密度PU大底, 优异的抓地性, 符合欧洲防滑最高标准 SRC
- 符合最新国标
- 尺码 35 - 47
- 2010 brand new modification to improve the comfort
 - Wider toe cap to fit Asian feet
 - Conform to Ergonomics design on ankle parts
 - Mesh lining to reduced the humidity inside of shoes
- High quality black full grain leather, thickness from 1.8mm to 2mm
- Brand new design double density PU outsole with excellent anti-slip ability, complied with SRC standard
- Complied latest GB standard
- Warm lining to be selected
- Size: 35-47

订货号 Ref. :
BC6240122B RALLYE 防静电, 防砸, 防穿刺
RALLYE Anti-static, Anti-impact, Anti-puncture

BC6240124B RALLYE 防静电, 防砸, 防穿
刺, 保暖内衬安全靴
RALLYE Anti-static, Anti-impact, Anti-
puncture, Warm lining

氯丁橡胶安全防护靴 NEOPRENE Boot

防护靴采用三重浸胶技术制造, 拥有更厚的氯丁橡胶涂层, 可以更有效抵抗多种危险化学品。

- 100% 防水
- 12"靴筒
- 无缝、浸胶结构, 各种环境下都能保持柔韧舒适
- Breathe-O-Prene鞋垫减震吸汗, 干爽舒适
- 结实、舒适的织物衬里
- NEO-Grip™ 外底和鞋跟
- 钢包头符合 ASTM F2413-05标准要求
- 22206型号增加跖骨防护, 符合ASTM F2413-05标准要求
- 12" height Neoprene III safety boots
- 100% waterproof
- Seamless construction is soft and pliable.
- Breathe-O-Prene insole provides shock absorption and pull away moisture
- Tough, comfortable fabric lining
- NEO-Grip™ sole and heel
- Steel toe meets ASTM F2413-05
- On 22206, Duraguard floating metatarsal guard meets ASTM F2413-05



订货号 Ref. :
22148 尺码: 6-13
22206 带跖骨防护 尺码: 5-15



订货号 Ref. : 75109

TDT® 三重密度注塑防化靴 XTP Safety Hi Boot

- 世界领先的TDT™ 三重密度注塑技术，一体成型！100%防水
- 防护靴外底由特殊配方的化合物制成，耐用，更高防滑等级
- 根据人体工程学原理制成的靴垫为可抽取，耐洗涤
- 加长的肋骨式钢垫片，提供有效的支撑
- 清洁靴外底
- FOOT FORM™轮廓脚感舒适
- 钢包头符合ASTM F2413-05标准
- 尺码：3-15
- Triple Density Technology bring seamless, 100% waterproof and confort
- Outsole compounds formulated for excellent traction and long wear
- Extended ribbed steel shank for support
- Graduated heights decrease calf chaffing
- TDT™ self-cleaning outsole
- FOOT FORM™ contour comfort
- Steel toe meets ASTM F2413-05



订货号 Ref. : 75145C

PVC高筒防护靴 PRM PVC Safety Hi Boot

- 优质的PVC原料，确保更安心的防护，延长使用寿命
- 钢底板及钢包头符合ASTM F2413-05和CAN/CSA Z195-02一级标准要求，防砸防穿刺
- 自洁式外底设计，便于使用后快速清洁
- 尺码：7 - 14
- Steel toe and steel midsole meets ASTM F2413-05 and CAN/CSA Z195-02 Grade 1
- Self-cleaning outsole design



订货号 Ref. : 18821

CT™高筒经济型防护靴 CT™ Economy Hi Boot

- CT™舒适科技提供了独特的扇形顶线设计，可以容纳小腿部分的伸缩，渐变的靴子高度提供更多的贴性和舒适性
- Trac10™ 外底设计，符合人体工程学原理，摩擦力更大，使用寿命更长，可有效防止鞋跟打滑
- EVA FOOT FORM鞋垫带来运动鞋般的全天候舒适感觉
- 钢包头符合ASTM F2413-05 标准要求
- 尺码：3 - 15
- CT (Comfort Technology) offers a unique scalloped top-line design to accommodate flexing in the calf area to reduce irritation as well as graduated boot heights that are consistent with shoe sizes for better fit and comfort.
- The unique Trac10™ sole design enhances traction and durability with an ergonomic frame design and interior lugs. The contour heel cup molding reduces heel slippage while the EVA FOOT FORM provides sneaker-like comfort for all-day wear.
- Steel toe meets ASTM F2413-05.



订货号 Ref. : 73104

Iron Duke®复合高聚物防护短靴 Iron Duke® Polyblend PVC 5-Eyelet Safety Shoe

- FOOT FORM™线形轮廓鞋垫穿起来更舒适
- Deep V-Trac鞋底摩擦力更大
- 无缝注塑设计，完全密封鞋舌，防止液体渗入
- 钢包头符合ASTM F2413-05要求
- 尺码：6 - 13
- FOOT FORM™ contour insole provides added comfort.
- Deep V-Trac sole and heel for added traction.
- Reinforced shank for added arch support.
- Steel toe meets ASTM F2413-05.



订货号 Ref. : 11003

SF防滑靴套 SF Slip-On Overboot

- 特大码设计，适合大码皮鞋
- 带有多节纹路的SF宽边鞋底摩擦力更好
- 尺码：XS - XL
- Supersized styling to fit over bulky leather footwear.
- SF wide grip outsole with textured treads for better traction.



订货号 Ref. : 11095

SF中筒防护靴套 Superfit Chem Mid High Overboot

SuperFit (SF)防护套靴是一款出色的特殊用途防护靴。符合MIL-0-43995C和A-A-59520商业规范。

- 结实耐用的一体式注塑结构
- 防滑自洁式鞋底
- 贴合
- 100% 防水保护
- 尺码：S-XL

Tested to meet the MIL-0-43995C and Commercial Spec A-A-59520, this overboot provides protection in hazardous situations.

- Highly durable, injection-molded one-piece construction.
- Slip-resistant, self-cleaning outsole.
- Super Fit construction.
- 100% waterproof protection.

工矿靴

Heavy Duty Boots

重型工矿靴

Heavy duty boot



订货号 Ref. : NMX 880

- 钢包头、钢底板及跖骨防护符合ASTM F2413-05要求
- 可有效提供从脚趾到脚面的全面防护
- 特殊的高强度复合橡胶材质，加厚设计，耐磨、防滑和耐老化性能良好
- 手工压层结构，富于柔韧性
- 复合材料制成的垫片，提供舒适的足部支撑。更有利于长时间工作
- 特别适用于煤矿，钢铁采矿行业
- 尺码：5-15
- Steel toe, metatarsal guard and steel midsole meet ASTM F2413-05
- Full polymeric foam insulation.
- Flexible, hand-layered construction provides comfort and protection for the long haul in hazardous, heavy-duty jobs
- Cushion insoles reduce fatigue
- Ultra-composite shanks reinforce construction and support the arch.
- Offers valuable protection in all kinds of industrial settings. The steel toe construction and hard-wearing tread features are ideal for oil rig or mining applications.

电力伤害防护靴

EH Protection

电力伤害防护靴

Ranger Dielectric Safety Mid Pac



订货号 Ref. : R6130

- 特殊优质抗氧化复合橡胶材质，柔韧的手工压层工艺制造。耐用尼龙衬里，更佳舒适且便于穿脱
- 内置式减震鞋垫减少脚部疲劳，带来全天候舒适
- 超复合材料垫片加强鞋体结构，有效支撑足弓
- SURE-LOC™鞋底和鞋跟采用平坦贴合锐边纹理，是室内作业的理想选择
- 钢包头符合标准ASTM F2413-05的相关要求
- 符合标准ASTM F2413-05中关于电力危险的防护要求（仅鞋底干法测试，测试电压20000V）
- ** 不可穿着于有爆炸风险或需要穿着导电足部防护产品的场所
- 尺码：6-13
- Premium grade rubber with safety yellow trim.
- Special ozone-resistant rubber compound.
- Flexible, hand-layered construction.
- Durable nylon linings for easy on/off .
- Built-in cushion insoles reduce fatigue for all-day comfort.
- Ultra-composite shanks reinforce construction and support the feet.
- SURE-LOC™ sole and heel has a flatter surface-to-surface, razor-edge tread that is ideal for indoor protection.
- Steel toe meets ASTM F2413-05.
- Meets electrical hazard requirements of ASTM F2413-05.(Tested only on outsole.)
- ** Do not wear these specialized boots near explosives or on any job requiring conductive footwear.



订货号 Ref. : A422

皮质靴面双重保暖中筒派克靴 Double Insulated Leather Top Mid Pac

- 优质皮靴面，防水橡胶鞋底
- Trac Tread™ 鞋底和鞋跟抓地牢靠
- 内置双重保暖泡沫提供惊人的温暖和更多保护
- 3/8英寸毛毡中底让脚下更加温暖
- 钢包头符合标准ASTM F2413-05的相关要求
- 舒适温度范围达到-59摄氏度
- 尺码：7-13
- Waterproof rubber bottom.
- Trac Tread™ outsole and heel ensure a solid grip.
- Built-in, double-insulating foam provides incredible warmth and extra protection.
- 3/8" felt midsole for added warmth underfoot.
- Steel toe meets ASTM F2413-05.
- Comfort Zone to -75°F



订货号 Ref. : A421

皮质靴面保暖中筒派克靴 Leather Top Mid Pac

- 优质皮靴面，防水橡胶底面。
- Bar Grip™ 鞋底和鞋跟防滑性能出色。
- 3/8英寸毛毡中底让脚下更加温暖。
- 钢包头及钢底板符合标准ASTM F2413-05的相关要求。
- 舒适温度范围达到-45.6摄氏度
- 尺码：7-13
- Waterproof rubber bottom.
- Bar Grip™ outsole and heel provide excellent traction.
- 3/8" felt midsole for added warmth underfoot.
- Steel toe & midsole meets ASTM F2413-05.
- Comfort Zone to -50°F



订货号 Ref. : A521



订货号 Ref. : A531

翻皮靴面保暖中筒派克靴 Suedu Leather Top Mid Pac

- 靴面为翻皮样式。性能参考以上防寒靴
- Same as above leather boots except suede leather design.

请注意，由于个人对冷暖和舒适感觉不同，制定理想的推荐工作温度只是一个美好的愿望，并不适用于所有人和所有情况。

消防战斗靴 Fire Fighter



订货号 Ref. : RJX

消防战斗靴 Fire fighter boot

- 由性能优异的复合阻燃橡胶材料制成。100%防水
- 舒适的足部支撑结构，长时间穿着有效减轻消防员的负担
- 钢包头及钢底板，以防砸、防穿刺
- 绝缘耐压5000V，漏电流小于3MA
- 卓越的隔热性能，优于GA6-2004标准三倍
- 独特鞋筒、提环及后跟踢块设计，便于携带、迅速穿脱
- 高亮度反光标识，易于辨认
- 符合GA 6-2004标准，通过国家消防装备质量监督检测中心检测
- 尺码：6-11
- Waterproof flame-resistant compound rubber boots
- Ultra-composite shanks reinforce construction and support the feet.
- Steel toe & midsole help to prevent from impactation and compression, puncture hazard.
- Meets insulation requirements of GA6-2004
- Excellent heat resistance performance, 3 times better than the requirement of GA6-2004
- Unique design of boots upper, pull-up loops and kick-off lugs on heel to provide easy of carry and donning.
- High visual trims on boots offer great reflection to others.

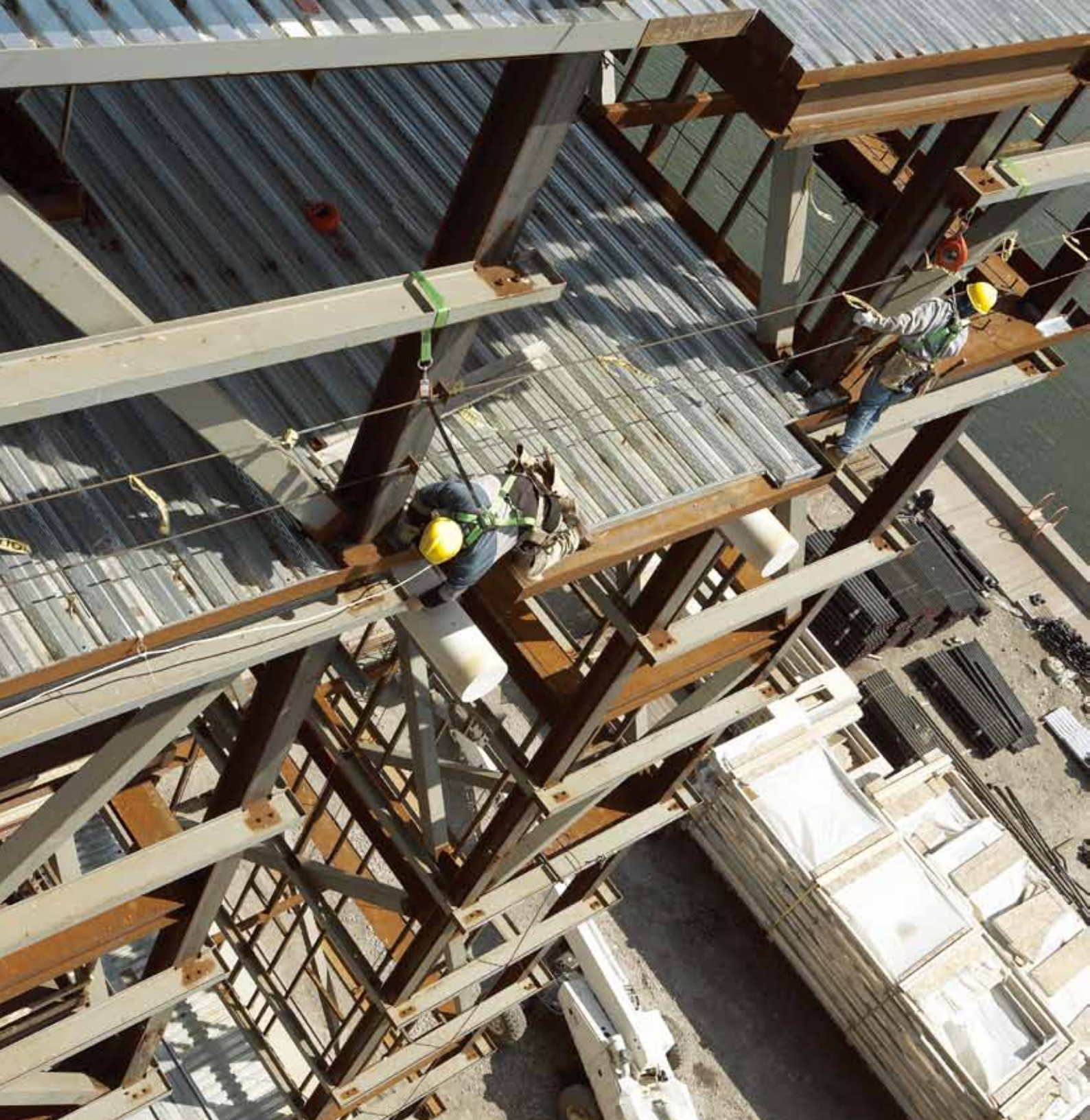

风电专用安全带	Wind Energy Harnesses	145
工业用安全带	Harnesses for Industrial Applications	146
特殊用途安全带	Harnesses for Special Applications	149
系绳（带）	Lanyards	150
坠落制动器	Fall Arrest Blocks	154
连接件和附件	Connectors	160
焊接类坠落防护产品	Welding Fall Protection Products	162
救援产品	Rescue Equipment	164
高空防坠落系统	Fall Protection System	165

个人坠落防护系统的基本组成

个人坠落防护系统能够将工人与悬挂点连接起来，从而完全避免坠落的发生或阻止自由坠落，使工人免受伤害。

悬挂装置、全身安全带及连接系统

这些产品单独使用时并不能提供坠落防护，然而，若恰当地组合使用这些产品，它们就构成了一套极为有效的个人坠落防护系统。

关于选择全身安全带的建议：

背部挂点（背部D型环）：

- 坠落防护安全带的基本挂点
- 能够连接各种坠落防护系统
- 不适合于悬挂作业

前侧挂点（前侧D型环）：

- 前侧连接装置，用于坠落制动
- 还可在救援时使用

前侧挂环：

- 使用安全钩把两个环连接起来，然后再与坠落制动装置连接
- 适合于各种攀登作业、密闭空间、救援和工作定位作业

侧面D形环：

- 在悬挂作业时起定位作用
- 不能用于坠落制动系统

Selecting the right harness:

Rear D-ring:

This is the basic attachment point on a harness for fall arrest. It is suited to standard site work where the worker only needs to be attached for safety and does not need to work in suspension at height.

Front D-ring:

Used together for fall arrest, a front attachment provides better control. Generally more comfortable to hang in, they may also be used in a rescue situation.

Front anchorage loops:

The loops are connected using a karabiner. A fall-arrest intermediate attachment is then connected to this. Used in a variety of climbing (with rope grabs), confined space, rescues and work positioning situations.

Side D-rings on the belt:

These D-rings must not be used for fall arrest applications. Most commonly used for work positioning where the worker is required to be suspended for extended periods of time. The use of a belt enhances the comfort for the worker.

个人坠落防护系统的基本组成

锚点及连接件

- 锚点（吊带、杆、三脚架等）：必须与个人坠落防护系统牢固地连接起来
- 其承载力需大于10KN，并维持3分钟以上（EN795标准，B级）
- 需位于尽量高处，以避免工人坠落时与地面或低层结构碰撞
- 连接件（挂钩、大口径安全钩等）：将连接系统与锚点连接起来
- 其承载力需大于15KN，并维持3分钟以上（EN362标准）

坠落防护全身安全带

- 发生坠落时能拉住作业人员，保证身体在坠落时不受伤害
 - 配有背带和腿带的全身安全带是唯一适合于坠落制动的产品
 - 应根据工作的种类和环境选择合适的安全带
 - 安全带上所有挂点的承载力必须大于15KN，并维持3分钟以上（EN361标准和EN358标准）
- ### 连接系统
- 将坠落防护全身安全带与挂点或连接件连接（吊绳、救生索等）
 - 必须能够限制坠落并应根据工作环境进行选择
 - 应计算可能坠落高度，以确定所需的连接系统

标准

EN353-1	导向型坠落制动器—刚性吊绳和导轨
EN353-2	导向型坠落制动器—柔性吊绳
EN354	系绳（带），最大长度：2米。
EN355	缓冲减震装置
EN358	工作定位系统
EN360	伸缩式坠落制动器
EN361	全身式安全带
EN362	连接件
EN795(b)	锚点装置
EN363	坠落制动系统

风电专用安全带 Wind Energy Harnesses

- 背部搭载ErgoArmor™装甲，其材质可随活动自由变形，并有效保护安全带本身及工人背部不受磨损
- 织带材质为专利的DualTech™形状记忆材料，可提供更佳的舒适性、强度和耐磨性
- 依据人体工程学设计的枢轴结点(PivotLink)与合扣(Cam buckle)设计，方便活动、调整与穿脱
- 同时符合欧洲(EN)及美洲(ANSI/CSA)坠落防护产品标准
- 专为国际风电应用设计

- ErgoArmor™ back shield: semi-flexible back shield minimizes impact from sharp / heavy snap hooks and self retracting lifelines
- Ultra-smooth DualTech™ webbing delivers excellent comfort and wear resistance
- Ergonomic PivotLink and Cam buckle design provides great comfort in mobility and easy one-hand adjustment
- Compliant to EN and ANSI/CSA fall protection standards
- Designed for international wind turbine workers



订货号 Ref. : 10 148 07 (S/M)
10 148 08 (L/XL)

Revolution R7 风电专用安全带，配有定位腰带 Revolution R7 Wind Energy Harness

- 配有1个后部挂点和前胸编织带双挂环，配有定位腰带
- Two-point harness, rear anchorage D-ring and front anchorage webbing loops, complete with positioning belt



订货号 Ref. : 10 156 03 (S/M)
10 156 04 (L/XL)

Revolution R8风电专用安全带，配有定位腰带 Revolution R8 Wind Energy Harness

- 配有1个后部挂点、前胸编织带双挂环和1个腰部挂点，配有定位腰带
- Three-point harness, rear anchorage D-ring, front anchorage webbing loops and waist anchorage D-ring, complete with positioning belt

工业用安全带 Harnesses for Industrial Applications

DuraFlex® 安全带 DuraFlex® Harnesses

- 得益于TEFLON纤维防护层，DuraFlex®全身式安全带比传统的安全带使用寿命更长。
- DuraFlex®安全带和 Manyard®系绳使用的所有编织材料都经过了这种高科技的无色防护层专业处理。
- TEFLON防水，油，脂，污垢积聚和混凝土灰尘，这些物质经常会造成安全带或系带材料的变质或腐蚀。
- 专利弹性织带，可配合使用者的动作伸展，提供绝佳的舒适性
- Increased Durability TEFLON®* contributes to extend the service life of the DuraFlex® harness as compared to conventional harnesses.
- An invisible high-tech protective treatment applied professionally to all DuraFlex® and Manyard® webbing.
- TEFLON®repels water, oil, grease, dirt and concrete dust that may cause the degradation and erosion of the harness and Manyard® webbing.
- Patented specially-formulated elastomer webbing that stretches to conform to the shape of the worker, providing unsurpassed comfort.



DuraFlex® 双挂点全身安全带 DuraFlex® 2-point Harness

- 带后部挂点和前部编织带挂环的全身安全带
- Two-point harness, rear and front anchorage webbing loops

订货号 Ref. : 10 028 49



DuraFlex® 三挂点全身安全带 DuraFlex® 3-point Harness

- 配有后部挂点和2个前胸挂点的全身安全带
- Three-point harness, rear and front anchorage D-rings

订货号 Ref. : 10 028 53



DuraFlex® 三挂点全身安全带，配有定位腰带 DuraFlex® 3-point Harness with Positioning Belt

- 带腰带，后部挂点和2个前侧挂点的全身安全带
- Three-point harness, with positioning belt, rear and front anchorage D rings

订货号 Ref. : 10 028 57

弹性编织带已在欧洲获得专利。Elasticated webbing has been patented in Europe.

★专利证号 Patent No. : 97937154.9.

★★Teflon® 是DuPont公司的品牌（聚四氟乙烯），为DuPont公司的独家产品。

标准型安全带 Standard Harnesses

标准型安全带是完全从使用者出发研发的符合所有工业及建筑行业需求的系列产品。标准的产品及些附加的功能，使得其成为性价比及功能兼备的坠落防护产品。

Standard full-body Harness family is a complete range of user-friendly fall protection products that meets industry and construction compliance requirements. Standard products with some add-on features make it a cost-effective choice for fall protection.

- 全身式可调节设计，一个规格的产品可适合所有身型
- 臀部托带设计确保使用者身体垂直
- 可滑动背部D型环佩戴更舒适
- 45mm宽胸带设计配金属调节扣
- Fully adjustable designs so one size fits all
- Sub-pelvic strap keeps the wearer upright
- Sliding back D-ring for a comfortable fit
- 45mm chest strap with metal buckle



订货号 Ref. : 10 118 90

单挂点标准型全身安全带 1-point Standard Harness

- 配有1个后部挂点的全身安全带
- One point harness, rear anchorage D-ring



订货号 Ref. : 10 118 91

双挂点标准型全身安全带 2-point Standard Harness

- 配有1个后部挂点和前胸编织带双挂环的全身安全带
- Two-point harness, rear anchorage D-ring and front anchorage webbing loops



订货号 Ref. : 10 118 94

双挂点标准型全身安全带，配有定位腰带 2-point Standard Harness with Positioning Belt

- 配有1个后部挂点和前胸编织带双挂环，配有定位腰带
- Two-point harness, rear anchorage D-ring and front anchorage webbing loops, complete with positioning belt



订货号 Ref. : 10 028 51 M/L

三挂点标准型全身安全带 3-Point Standard Harness

- 带后部挂点和2个前侧挂点的全身安全带
- Three-point harness, rear and front anchorage D-rings

经济型安全带 Value Harnesses

专为中国市场设计

- 结构简单，穿戴方便
- 编织带材料重量轻，降低工作强度
- 多种选择，经济耐用

Value product designed for China market

- Simple structure, easy to wear
- Low weight webbing, reduce fatigue
- Multi-choices, cost saving



订货号 Ref. : DL-30

单挂点经济型全身安全带 1-Point Value Harness

- 单挂点交叉式全身安全带（背部挂点）
- 1-point cross over full-body harness (rear anchorage)



订货号 Ref. : DL-31

双挂点经济型全身安全带 2-Point Value Harness

- 双挂点交叉式全身安全带（背部和前部挂点）
- 2-point cross over full-body harness (rear and front anchorage)



订货号 Ref. : DL-35

双挂点经济型全身安全带, 配有定位腰带 2-Point Value Harness with Positioning Belt

- 双挂点交叉式全身安全带，配有定位腰带（背部和前部挂点，腰侧定位D型环）
- 2-point cross over full-body harness with positioning belt (rear and front anchorage and side D rings)



订货号 Ref. : DL-C1

单挂点集成式全身安全带 1-Point Value Harness With Shock-Absorbing Lanyard

- 单挂点集成缓冲系带式全身安全带，配有一个脚手架挂钩
- 1-point value harness with shock-absorbing lanyard (complete with one scaffold hook)



特殊用途安全带 Harnesses for Special Applications

救援安全带 Harnesses for Rescue



订货号 Ref. : 10 102 52

RAM 救援坐带 RAM Sit Harness

轻便灵活的救援坐带，适用于登山紧急救援类应用的短期使用。

The easy to fit lightweight flexible sit harness is suitable for Mountain Rescue technicians where the harness is worn for short durations only.

输电塔作业 Transmission Tower Works



订货号 Ref. : 10 034 38

RM 全身式安全带 RM Full-body Harness

弹性的肩带给予使用者极大的活动自由度，同时极大降低工作疲劳程度。

宽厚的腰垫和脚带给予悬吊作业极大的支撑。

前部挂环、提供配合抓绳器使用时的前部挂点。

Elasticated webbing on the shoulder straps stretches with the user to provide greater freedom of movement and comfort with reduced fatigue.

The padded belt and leg straps provide excellent support for work in suspension.

The front anchorage loops provide an ergonomic anchorage point for use with a rope grab.



订货号 Ref. : 10 070 22

IBEXX-2R 全身式安全带 IBEXX-2R Full-body Harness

This fall arrest and work-positioning harness offers excellent suspension comfort and minimises suspension trauma during rope access work. The lower belay loop and sternal attachment point provide an anchorage point for a descender and fall arrest device respectively.

本产品将坠落防护和工作定位的功能完美结合，提供 大的悬吊舒适性，同时将绳上作业可能产生悬吊创伤的机会减小。低位（腰部）的绳圈和D型环，为缓降器和其他坠落防护设备提供了坚实的挂点。

系绳（带） Lanyards

缓冲系带 Shock-absorbing Lanyards

与缓冲器集成的可伸缩系绳，减少绊倒的危害

Stretchable shock-absorbing lanyard, for reduced tripping hazards

- 独一无二的伸缩设计，提供使用者更大的机动性和安全性。
- 当收缩的时候（正常状态），它大大的减少了工作距离从而减少使用者被绊倒、钩挂和拖拽的可能性。
- 当不使用的时候可以通过产品上的安全扣加以固定从而减少绊倒危险
- **A UNIQUE stretchable design for greater manoeuvrability and safety.**
- **When contracted, it greatly reduces the risks of tripping, snagging and dragging.**
- **A safety clip that straps on to the harness to hold the Manyard® when not in use, thus limiting tripping risks.**



订货号 Ref. : 10 053 18

Manyard™ 系带 Manyard™ Lanyard

- 缓冲系带，表面经过TEFLON®处理，配有2个安全钩。
- Shock-absorbing lanyard with Teflon® finish, complete with two galvanised karabiners.



订货号 Ref. : 10 053 25

Manyard™ 系带 Manyard™ Lanyard

- 缓冲系带，表面经过TEFLON®处理，配有脚手架挂钩和安全钩。
- Shock-absorbing lanyard with Teflon® finish, complete with scaffold hook and galvanised karabiner.

BackBiter® 反扣系带——第一种专为反扣设计的系带

BackBiter® Tie-back lanyard: First lanyard designed for tie-back use

普通系带的编织带和抓钩—包括那些所谓的“可反扣”系带—它们的设计不可能承受系带反扣时产生的恶劣状况。Miller的新型BackBiter®反扣系带配有5K™抓钩，彻头彻尾是按照反扣用途设计的。

- 第一种在任何角度—包括锁门，都可以承受2.5吨负载的抓钩
- 高强度Cordura®尼龙编织带可以提供比普通编织带高5倍的耐磨能力
- 一体式的系带，同时包括了Sofstop®缓冲包和挂点连接部件，减少了库存产品的品种，工人也更容易接受使用它。

The webbing and snap hooks of regular lanyards - and that includes the so-called “tie-back” lanyards available elsewhere - are not designed to withstand the rigors of tying back. The new Miller BackBiter® tie-back lanyard with a 5K™ snap hook was designed from top to bottom for tie-back use.

- First snap hook with a 5,000 lbs capacity from every angle – including the gate
- Heavy-duty Cordura® nylon webbing provides five times more abrasion resistance.
- All-in-one lanyard w/Sofstop® shock absorber and cross-arm anchorage connector reduces inventory and increase worker compliance.

现在，您终于可以第一次真正安全的将系带反扣来使用了！将普通的系带反扣使用是不安全的。过去不是，将来也不会！

Now, for the first time, you can tie-back SAFELY. Tying back with a regular lanyard is not safe. Never has been. Never will be.



订货号 Ref. : 913B-SN

BackBiter® 缓冲系带

BackBiter® Shock-absorbing Lanyard

- BackBiter®缓冲系带，配有5K™抓钩
- BackBiter® Lanyard w/5K snap hook



订货号 Ref. : 8798B-SN

BackBiter® 双叉型缓冲系带

BackBiter® Shock-absorbing Lanyard

- BackBiter® 双叉型缓冲系带，配有5K™抓钩
- Two-legged BackBiter® lanyard w/5K snap hooks

缓冲系绳/带 Shock-absorbing Lanyards



订货号 Ref. : 10 029 07 (2m)

缓冲系绳 Shock-absorbing Lanyard

- 缓冲系绳, 带有2个安全钩
- shock-absorbing rope lanyard, complete with 2 karabiner



订货号 Ref. : 10 045 90 (1.2m)

缓冲系带 Shock-absorbing Lanyard

- 双叉型编织缓冲系带, 带有1个安全钩和2个脚手架挂钩
- Double-leg webbing shock-absorbing lanyard, complete with a karabiner and two scaffold hooks



订货号 Ref. : 10 045 91 (2m)

缓冲系绳 Shock-absorbing Lanyard

- 缓冲系绳, 配有1个脚手架挂钩和1个安全钩
- Shock-absorbing rope lanyard, complete with a scaffold hook and a galvanized karabiner

经济型缓冲系绳 Value Shock-absorbing Lanyards



订货号 Ref. : DL-50 (2m)

缓冲系绳 Shock-absorbing Lanyard

- 12毫米粗, 配有1个抓钩和1个连接环
- 12mm rope, equipped with a snap hook and a connection loop



订货号 Ref. : DL-51 (2m)

缓冲系绳 Shock-absorbing Lanyard

- 12毫米粗, 配有1个脚手架挂钩和1个连接环
- 12mm rope, equipped with a scaffold hook and a connection loop

限位系绳 Restraint Lanyards



订货号 Ref. : DL-55 (2m)

限位系绳 Restraint Lanyard

- 12毫米系绳，配有1个抓钩和1个连接环
- 12mm rope, equipped with a snap hook and a connection loop



订货号 Ref. : DL-56 (2m)

限位系绳 Restraint Lanyard

- 12毫米系绳，配有1个脚手架挂钩和1个连接环
- 12mm rope, equipped with a scaffold hook and a connection loop



订货号 Ref. : 10 028 81 (1m)

限位系绳 Restraint Lanyard

- 带有1个绳圈和1个安全钩
- With loop and connector

脚手架缓冲系绳 Scaffolding Lanyards



订货号 Ref. : 10 101 41 (1.7m)

Barracuda™ 脚手架缓冲系绳 Barracuda™ Scaffolding Lanyard

- 缓冲系绳，配有竖向脚手架夹钩和安全钩
- Shock-absorbing rope lanyard, complete with vertical scaffold clamp and karabiner

坠落制动器 Fall Arrest Blocks

绝佳的缓冲系绳升级方案
极其轻便的个人坠落限制器
The best alternative to
shock-absorbing lanyard



TurboLite™ 系列坠落制动器 TurboLite™ Personal Fall Limiter

- 设计极其轻巧(仅0.86公斤), 可提供1.8米的工作长度。制动器本身可直接挂在安全带的后部挂点, 使作业者的行动更加灵活及便利。
- 坚固的编织系带, 耐磨性佳, 使用寿命长。
- 高防腐性能的不锈钢、铝合金及抗冲击的聚合材质部件所组成, 可在恶劣环境下使用, 延长使用寿命, 降低更换成本。
- 高强度、抗冲击的尼龙外壳, 耐用可靠。
- 内置旋转接头, 使用时防止系带旋转缠绕
- Extremely compact and lightweight (0.86kg) provides 1.8m working capacity lifeline; unit attaches directly to the harness back D-ring for greater mobility and versatility
- Engineered webbing for greater abrasion resistance and long service life
- Corrosion-resistant stainless steel, aluminum and high impact polymer internal components extend service life and reduce cost of ownership
- High-strength, impact-resistant nylon housing for maximum durability
- Built-in swivel prevents lifeline from twisting

- 订货号 Ref. : MFL-1/6FT (1.8m) 配有1个抓钩和1个安全钩
equipped with a snap hook and a karabiner
- MFL-2/6FT (1.8m) 配有1个安全钩和1个脚手架挂钩
equipped with a scaffold hook and a karabiner
- MFL-3/6FT (1.8m) 配有1个抓钩
equipped with a snap hook

坠落制动器 Fall Arrest Blocks



MiniLite™ 系列坠落制动器 MiniLite™ Fall Limiter

重量轻，体积小且具备自动回收和快速锁紧制动功能的坠落制动器，将坠落距离限制在以厘米计算的距离内。3米长度的自动伸缩带给使用者移动更大的自由度。高强度的复合材料外壳和耐腐蚀的内部结构，大大提升了使用寿命

The lightweight, palm-sized self-retracting fall arrest block with a quick activating braking system that limits freefall to centimetres. The 3 metre retractable webbing allows greater freedom of movement. The high-impact composite housing and corrosion resistant interior increase the product durability.

订货号 Ref. : 10 061 00 (3.1m) 配安全钩和万向抓钩

with karabiner and swivel snap hook

10 061 01 (3.1m) 配抓钩和万向脚手架挂钩

with snap hook and swivel scaffold hook

10 061 02 (3.1m) 配安全钩和抓钩

with karabiner and snap hook



ML20

配备了缓冲减震包的ML20，最大工作长度：2.5米，大大降低了坠落冲击强度，同时配备两个基本旋紧式安全钩。

Inertia reel fall arrester with a working capacity of 2.5m, the ML20 features an integral shock-absorber to reduce the impact force of a fall, and comes with two screw karabiners.

订货号 Ref. : 10 028 71 (2.5m)

MightyLite™ 伸缩式安全索坠落制动器 MightyLite™ Self-retracting Lifelines

坚固，紧凑、易用的坠落制动器。具备冲压而成的钢制外壳、高品质的镀锌/不锈钢缆绳、D 特的坠落指示器等众多特性。

Heavy-duty performance from a compact and easy-to-use block that features pressed steel housing, stainless steel springs and a fall indicator. Supplied with a swivel snap hook.



订货号 Ref. : 10 028 27 (6.2m)



订货号 Ref. : 10 045 71 (10m)



订货号 Ref. 10 045 72 (20m)

10 045 74 (30m)

10 045 94 (30m) 不锈钢缆 Stainless steel wire

10 045 75 (40m)

10 045 95 (40m) 不锈钢缆 Stainless steel wire

RL175G/175FT (54m)

MightyLite™ 坠落制动器 MightyLite™ Fall arrest block

- 钢制外壳，编织带系绳
- **Steel housing blocks, complete with webbing cable**

MightyLite™ 坠落制动器 MightyLite™ Fall arrest block

- 钢制外壳，镀锌钢缆
- **Steel housing block, galvanised wire**

MightyLite™ 坠落制动器 MightyLite™ Fall arrest block

- 钢制外壳，镀锌或不锈钢缆
- **Steel housing block, galvanised wire or stainless steel**

Falcon™ 坠落制动器 Falcon™ Self-retracting Lifelines

向您推荐市场上重量 轻， 坚固耐用的复合材料外壳坠落制动器。

Introducing the lightest, most rugged line of composite retractables on the market. Pound for pound the strongest, most durable, retractable lifeline available.

- 耐腐蚀：内部结构采用不锈钢和铝合金材料，延长了使用寿命并降低了更换费用。
- 市场上 轻的复合材料外壳坠落制动器：携带方便，操作轻松。
- 独特的单侧伸缩结构：减少缆绳伸缩时与壳体的摩擦而造成的磨损，伸缩更顺畅。
- 两端配有万向旋转接头（壳体 and 缆绳顶端），防止使用时缆绳上产生扭力。
- 坠落指示器：指示该产品是否还能继续使用。
- 新推出织带版本为市场上重量 轻的6m坠落制动器之一（仅1.5公斤！）
- Corrosion-resistant: stainless steel and aluminum internal components extend service life and reduce replacement costs.
- Lightest composite unit on the market: easy to handle and transport to/from jobsites.
- Unique side payout design: reduces wear on the entry guide bushing and cable for smooth operation with less drag.
- Dual swivels (unit top and snap hook) included on all models too prevent lifeline from twisting during use.
- Visual load indicator – indicates the unit must be removed from service.
- New webbing version: one of the lightest 6m retractables in the market (only 1.5 kg!)



订货号 Ref. : MP20G/20FT (6.2m)
MP30G/30FT (10m)

Falcon™ 坠落制动器 Falcon™ Fall Arrest Block

- 复合材料外壳，重量轻，高强耐磨织带
- composite housing lightweight block, high abrasion-resistance webbing lifeline



Falcon™ 坠落制动器 Falcon™ Fall Arrest Block

- 复合材料外壳，重量轻，高强耐磨织带
- composite housing lightweight block, high abrasion-resistance webbing lifeline

- 订货号 Ref. :
- 1016794 (6米，配有1个万向脚手架挂钩和1个安全钩)
(6 meters, equipped with a scaffold hook and a karabiner)
 - 1016795 (6米，配有1个万向安全钩和1个安全钩)
(6 meters, equipped with two karabiners)
 - 1016796 (6米，配有1个万向安全钩和1个抓钩)
(6 meters, equipped with a karabiner and a snap hook)

Black Rhino™ 坠落制动器

Black Rhino™ Self-retracting lifeline

Black Rhino™ 伸缩式安全索-向您推荐市场上体积小、重量轻的**2.7米**钢缆式坠落制动器！
Black Rhino™ Self-retracting lifeline - Introducing the smallest and lightest 2.7m cable lifeline on the market!

- 在混凝土结构施工，焊接时和仓库中应用非常理想，这些使用场合要求坠落防护产品牢固耐用、安全可靠，只有钢缆式坠落制动器可以满足这样的条件。
- 2.7米的工作长度允许更大的活动空间，同时提高了生产力（工作效率）。
- 快速反应，高强度不锈钢制动系统：可以将自由坠落制止在几英寸的距离内，有利于快速，安全的救援。
- 坠落指示器：指示该产品是否还能继续使用。
- 配有安全钩
- Ideal for concrete construction, welding and warehouse applications that require durability and reliability that only a cable lifeline can provide
- 2.7m for working capacity offers greater mobility and increase productivity
- Quick-activating, high-strength stainless steel braking system – arrests free falls within inches providing for a quick, safe rescue.
- Visual load indicator – indicates the unit must be removed from service
- Complete with carabiner



Black Rhino™ 坠落制动器

Black Rhino™ Self-retracting Lifeline

- 坠落制动器，不锈钢缆绳，配有安全钩
- Self-retracting lifeline complete with stainless steel wire and carabiner

订货号 Ref. : CFL-2 (2.7m)

钢缆抓绳器 Cable Grabs

凭借超过20年在设计和生产绳索和钢缆抓绳器的成功经验，我们可以提供给您 简便、可靠且重量轻的产品。无论你是在坠落或滑脱的状态下，我们的产品都会立即将您紧紧的锁定在绳索或钢缆上。自动制动的抓绳器无须他人协助一人即可操作完成

No other supplier can match the proven performance and 20 year experience of Miller in rope grabs and cable grabs - years which have resulted in simple design and reliable lightweight products. In the event of a fall or slip, they lock onto the rope or cable, arresting the fall immediately. The automatic grabs follow the worker without assistance.



订货号 Ref. : 10 028 68 (8mm)

MG00 MicroLoc Cable Grab

MicroLoc 自动不锈钢钢缆抓绳器，完全符合EN353-1标准。可以适合众多已建成的爬梯系统，是危险工作环境的理想选择。

MicroLoc automatic stainless steel cable grab. Complies with EN353-1. For retrofitting onto existing ladder systems. Ideal for harsh environments.

自动及手动抓绳器 Automatic and Manual Rope Grabs

- 适合垂直、水平和有斜坡的工作需求
- 适合10/12mm or 14/16mm 的安全绳
- 垂直方向自动锁紧一无须人工干预，可在缆绳上自由滑动
- 水平方向的应用主要是人工定位，使用者将抓绳器锁紧在缆绳上做限定工作区域的用途，可以通过手工操作变换定位位置。
- Suitable for vertical, horizontal and sloping applications.
- Suitable for 10/12mm or 14/16mm rope.
- Automatic locking for vertical use – the rope glides freely over the line without manual intervention.
- Manual position for horizontal work. The user locks the grab on the rope for restraint purposes, and repositions it manually along rope.

抓绳器 Rope Grab

- 自动和手动双功能抓绳器，不带系绳，适合 14mm/16mm 绳
- Automatic and manual rope grab without lanyard, suitable for 14mm/16mm rope



订货号 Ref. : 10 028 75

抓绳器 Rope grab

- 自动和手动双功能抓绳器，带有0.3米长的系绳，适合 14mm/16mm 绳
- Automatic and manual rope grab with 0.3m lanyard, suitable for 14mm/16mm rope



订货号 Ref. : 10 028 76



订货号 Ref. : 10 045 12 (200m)

安全绳 Rope

- 10.5mm 包芯耐磨安全绳
- 10.5mm Kernmantel rope



订货号 Ref. : 10 028 91 (10m)
 10 028 92 (20m)
 10 028 93 (30m)
 10 028 94 (40m)
 10 028 95 (50m)

安全绳 Rope

- 直径14mm, 适用于 14mm/16mm 抓绳器
- 14mm diam, suitable for 14mm/16mm rope grabs

连接件和附件 Connectors



订货号 Ref. : DL-25

工作定位系绳 Work Positioning Lanyard

- 16毫米绳, 带有绳长调节器和1个抓钩
- 16mm twisted rope with rope adjuster and a snap hook



订货号 Ref. : 10 028 62

定位腰带 Work Positioning Belt

- 工作定位和限位腰带, 配有腰侧和腰后D型环
- Work positioning and restraint belt, complete with 2 lateral and 1 back ring.



订货号 Ref. : DL-20

工作定位腰带 Work Positioning Belt

- 带有舒适透气的腰部衬托和2个腰侧D型环
- Airflow comfort back support with 2 lateral D rings



订货号 Ref. : 10 082 82

缓冲包 Shock-absorbing Pack

- 缓冲包，配有2个连接环
- Shock-absorbing pack, complete with two loops



订货号 Ref. : 10 029 17 (0.8m)
10 029 19 (1.5m)

锚点吊带 Anchorage Sling

- 编织悬挂吊带
- Webbing anchorage sling



订货号 Ref. : 10 189 60

安全钩 Karabiner

- 钢制螺纹锁紧安全钩，17毫米开口
- Steel screw gate connector, 17mm opening



订货号 Ref. : 10 189 69

安全钩 Karabiner

- 轻质合金扭转锁紧安全钩，20毫米开口
- Light alloy twist lock karabiner, 20mm opening



订货号 Ref. : 10 189 77

脚手架挂钩 Scaffold Hook

- 双截止合金脚手架挂钩，63毫米开口
- Double action aluminium scaffold hook, 63mm opening



订货号 Ref. : 10 189 71

安全钩 Karabiner

- 轻质合金扭转锁紧安全钩，23毫米开口
- Light alloy twist lock karabiner, 23mm opening



订货号 Ref. : 10 043 24

安全钩 Karabiner

- 轻质合金螺纹锁紧安全钩，16毫米开口
- Light alloy screw gate connectors, 16mm opening

焊接类坠落防护产品 Welding Fall Protection Products



订货号 Ref. : 751K/UBLU

焊工全身式安全带 Welder Full-body Harness

- 蓝色阻燃Nomex® 编织带，内芯采用色彩醒目的黄色Kevlar®材料
- 特殊的编织带可以防护焊接火花
- 内芯材料增强强度和耐高温能力
- 鲜艳的颜色方便检查
- Blue, flame-retardant Nomex® webbing with contrasting yellow Kevlar® core
- Special webbing protects against weld splatter
- Inner core add strength and high temperature resistance
- Bright contrasting colors make inspection easier



订货号 Ref. : 907K/6FTBL (1.8m)

焊工缓冲系绳 Welder Shock-absorbing Lanyard

- 特别设计的SofStop缓冲包采用蓝色阻燃Nomex® 编织带
- 内芯采用高强度Kevlar® 材料
- Specially designed SofStop absorber with blue, flame-retardant Nomex® cover.
- Heavy-duty Kevlar® back-up strap.

SafEscape ELITE自动缓降逃生装置 SafEscape ELITE Automatic Rescue / Descent Device

新一代的高空救援解决方案

高空作业人员在应急逃生及救援行动中，设备的安全性是重要的考量。因此我们开发了全新一代的高空逃生救援解决方案，其优异的设计，满足目前世界上严苛的测试标准 – 欧盟 EN 341/2008，致力于确保您高空作业人员的安全。

The Next Generation Rescue Solution

During the rescue or evacuation operation of an high access worker, safety is of paramount importance and that is why we have developed the next generation rescue solution. The unit has been engineered to comply with the most rigorous testing methods, set out by the forthcoming EN 341/2008 standard. This will ensure the Safety of the people working at height.

- 满足严苛的2008年版prEN 341/2008欧洲逃生设备标准：
- 100kg工作载重下可连续使用8,000米(16次x 500m)
- 最大缓降高度达500米
- 可同时2人使用，工作载重可达250kg
- 优异的耐候性，根据欧洲标准prEN 341/2008可在潮湿环境下使用
- 外壳由高质量的高强铝合金制成，可在各种恶劣环境下使用
- 设备组件坚固耐用，可七年不须回厂检查，节约维护成本及时间
- 手轮的位置及设计可在提升作业时有效减低晃动，有助于疏散作业
- 以离心制动装置控制缓降速度及降低震动，实现快速(1米/秒)而平顺的缓降作业
- 同时具备欧盟CE认证并符合美国ANSI/OSHA标准，提供完美的全球解决方案
- Complies with the stringent prEN 341/2008 standard for descending devices
- 8,000 m descent for 100 kg (16 x 500 m)
- Maximum descent height of 500 m
- Can be used by 2 people weighing up to 250 kg
- Has been tested to withstand the rigors of bad weather: in dry, but in accordance to the new EN341/2008 also in wet conditions
- Thanks to its durable high-quality anodized aluminum housing, our unit remains in optimum condition of use, even in the toughest environments
- Factory recertification is required only after seven years thanks to its robust and highly resistant components, thereby reducing down time and lowers the cost of ownership
- The position and design of the hand wheel reduces swaying during lifting, facilitating evacuation procedures
- Descent is quick (1m/s) and smooth, thanks to a centrifugal brake, which controls the descent and reduces vibration
- The unit is CE certified and meets ANSI and OSHA requirements, making it the perfect unit when a global solution is required



SafEscape ELITE 逃生装置 SafEscape ELITE Automatic Descent Device

订货号 Ref. : 10 287 56 (80m)
10 287 58 (100m)



SafEscape ELITE 救援逃生装置 SafEscape ELITE Automatic Rescue / Descent Device

订货号 Ref. : 10 287 75 (80m)
10 287 77 (100m)

救援产品 Rescue Equipment



三脚架 Tripod

- 铝制三脚架，脚腿长度可调节带有橡胶垫，高度2.1米
- Aluminium tripod, fully adjustable legs with rubber feet, height 2.1m

订货号 Ref. : 10 050 41



绞盘 Winch

- 操作简单，机械效率5:1。带有超速制动系统。工作长度20米
- Easy operation, mechanical efficiency 5:1, with over-speed braking system, length 20m

订货号 Ref. : 10 050 42



INDY 救援套件 INDY Rescue Kit

- 自救套件，包括INDY手控下降器，20米安全绳，悬挂吊带和存储包。
- Self rescue kit including an INDY descender, 20m rope, anchorage sling and storage bag.

订货号 Ref. : 10 060 26



Evac 轻型救援担架 Evac Body Splint

- 可水平或垂直使用，用于在密闭空间将伤员固定及运送。
- 体积小、重量轻、方便储存及携带。
- Can be lifted horizontally or vertically, ideal for confined space evacuation and rescue.
- Compact and lightweight design for easy storage and use.

订货号 Ref. : 10 070 46

高空防坠落系统 Fall Protection System



哪种高空防坠落系统对您合适？

目前市面上有多种高空防坠落系统，但它们在设计和用途上有很多重大的差别。要选择 合适的系统，必须首先对其安全特点、功能、使用方便性进行综合评估，另外，还应该考虑其耐久性、维修保养的时间和成本以及长远价值。

针对不同的作业场合，高空防坠落系统的设计应当考虑到每个用途细节。这能将高空坠落的风险降低到最低，并极大地提高工作效率。

Which fall protection system is most suitable for you?

Various systems are available in the market, but there are important differences in design and application. To be sure you choose the best system you need to firstly evaluate the feature, function, ease of use. And additionally durability, maintenance time and cost, and long term value should be assessed together.

In all cases, fall protection systems should be designed for each specific application. This will minimize the risk of a fall from height and maximize the efficiency of the work being carried-out.

我们的系统！

- Söll GlideLoc® 导轨系统
- Söll Xenon 水平生命线系统
- Söll Xenon 头顶式水平生命线系统
- Söll Vi-Go 垂直钢缆系统

Our System

- Söll GlideLoc® System
- Söll Xenon Horizontal Lifeline System
- Söll Xenon Overhead System
- Söll Vi-Go Vertical Cable System

Söll GlideLoc® 导轨系统 Söll GlideLoc® System

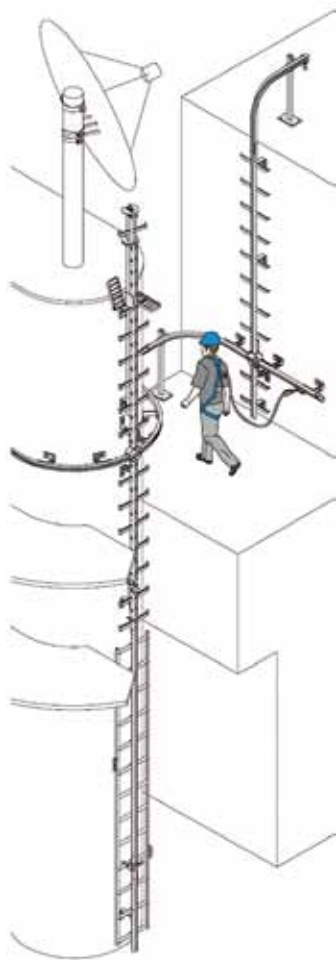

订货号：按照方案整套订货
Ref. : kit acc. to solution

Söll GlideLoc® 导轨系统是永久安装在大楼、高塔、天线杆等上的符合EN353-1标准的防坠落系统。其上装有能往返滑动的导轨型防坠落制动器。可以在现有的梯子上安装导轨系统，或者直接安装完整的安全爬梯系统。另外，我们还可以提供可固定在大多数结构上的各类安装夹具等零部件。

Söll GlideLoc®系统通过CE认证，符合全球安全标准（EN, OSHA, ANSI, AS/NZS, CAS, GB）。

Söll GlideLoc® is a climbing system, permanently installed on buildings, towers, masts, etc... comprising a guided type fall arrester, which glides up and down a steel or aluminium notched guide rail. The rails can be retrofitted to existing ladders, or alternatively are incorporated in a complete safe climbing system. A wide range of mounting brackets are available for fixing to most structures.

The GlideLoc® system is CE-certified and meets the international standards and regulations of EN, AS/NZS, CSA, OSHA, ANSI.

Söll GlideLoc® 导轨系统适用于：电信、无线电及电视地天线杆、建筑、供电及水电装备、风力设施及烟囱、工厂、大楼、石油化工单位、陆上和近海石油钻塔、造船业、起重机安装、竖井及检修孔、飞机修理库、火车及车辆地装卸场所等。

Söll GlideLoc® System is used in: telecommunications, radio and TV masts, construction, power supply and hydroelectric installations, wind power facilities, chimney and industrial plants, buildings and facades, petrochemical plants, on-shore and off-shore oil rigs, shipbuilding, crane installations, shafts and manholes, aircraft hangars and for loading/unloading of trains and vehicles.



导轨
Rail



爬梯
Ladder



导向型坠落制动器
Guided fall arrester



导轨撤离部件
Exit section



十字转盘
Turntable

可折叠式休息平台
Folding footrest

Söll Xenon 水平生命线系统 Söll Xenon Horizontal Lifeline System

Söll Xenon 水平生命线系统是符合EN795标准的水平全自动防坠落挂点装置。与市场上其它竞争产品相比，该产品更符合人体工程学原理，且构件数量更少。

Söll Xenon System is an automatic horizontal anchorage device, which complies with the requirements of EN 795. Compared with other products in the market, Xenon products are designed more ergonomically, and there are fewer components.

Söll Xenon 水平生命线系统适用于在高空的安装、维修和清洁等作业，可以用于工厂、大楼、起重机轨道、飞机修理库、大型体育场馆、火车及车辆地装卸场所等。

Söll Xenon System is used for installation, maintenance and cleaning at height, also in industrial plants, buildings, crane rails, aircraft hangars, big stadium, for loading/unloading of trains and vehicles.

订货号：按照方案整套订货

Ref. : kit acc. to solution

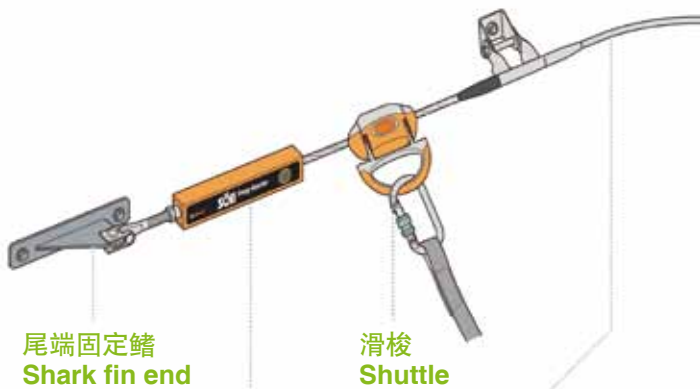

尾端固定鳍
Shark fin end anchor

滑梭
Shuttle

转角单元
Corner unit

多功能能量缓冲器
Multifunctional energy absorber

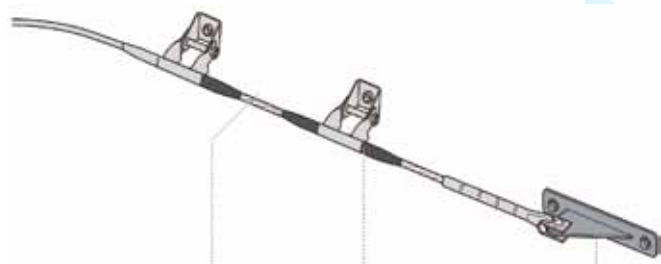

8mm 钢缆
8mm cable

末端固定件
End anchor

中间支架
Intermediate support



滑梭
Shuttle



多功能能量缓冲器
Multifunctional energy absorber

Söll Xenon 头顶式水平生命线系统 Söll Xenon Overhead System



订货号：按照方案整套订货
Ref. : kit acc. to solution



滑板
Shuttle

Söll Xenon 头顶式水平生命线系统安装于头顶，符合EN795标准的水平全自动防坠落挂点装置。可以与垂直坠落制动器组合成覆盖垂直与水平方向的全方位的坠落防护系统。

Söll Xenon Overhead System is an automatic fall protection anchorage device, which complies with the requirements of EN 795 and is fixed above the user's position. It can be used with self-retracting fall arrester to cover wider fall protection ar



多功能能量缓冲器
Multifunctional energy absorber

Söll Vi-Go 垂直钢缆系统 Söll Vi-Go Vertical Cable System

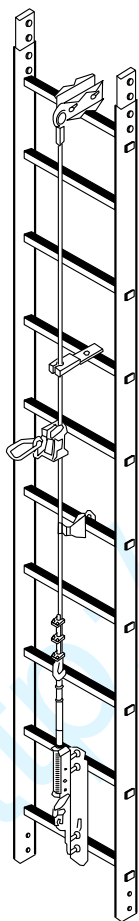

钢缆张紧器
Cable tensioner

Söll Vi-Go 垂直钢缆系统是安装在已有的爬梯或者塔架上，符合EN353-1标准的垂直全自动防坠落安全系统。

基本组成为钢缆、张紧器和导向型防坠落制动器。
Söll Vi-Go is an automatic vertical fall protection system used in OEM or retrofitted onto existing climbing devices such as ladders or rungs, complies with EN 353-1. The principal components of the system are: cable, cable tensioner and fall arrester.

Söll Vi-Go 垂直钢缆系统适用于风力塔、电力塔杆、电信塔、无线电及电视地天线杆、建筑等行业。

Söll Vi-Go Vertical Cable System is used in wind turbine, power supply, telecommunication, radio and TV masts, construction, and others.



坠落制动器
Fall arrester

订货号：按照方案整套订货
Ref. : kit acc. to solution



HRC2电弧防护装备
HRC4电弧防护装备
电工绝缘手套

HRC2 Arc Flash Protection Equipment 171
HRC4 Arc Flash Protection Equipment 172
Insulating Gloves 173

电力安全防护

霍尼韦尔电力安全防护及旗下品牌一直致力于提供好的安全防护产品，时至今日已经成为整个行业值得信赖的一面。我们深知我们的产品与电工性命攸关，所以我们在设备、工艺、人员等各个环节严格把关，执行可以达到的高标准，所有的产品都通过了ISO9001:2000国际质量体系认证。正是这种生命高于一切的信仰，和对产品质量的精益求精，使得霍尼韦尔电力防护一直保持着全球电力安全防护装备领导者的地位。我们不仅提供传统的防触电（电击）产品，同时还提供全方面的电弧防护装备，我们不仅为工业普通客户提供适用的防护产品，同时也为输配电、发电等高端客户提供高等级专业防护器具。



触电伤害

即使是较低的电压也可能产生致命的伤害。例如对于通常的60Hz交流电，如果电流从手至脚持续1秒钟就可导致如下反应：

电流	人体影响
0.5 - 3 mA	刺痛
3+ mA	击打，休克
10+ mA	抽搐和疼痛
30+ mA	呼吸麻痹
50+ mA	心脏麻痹（可以致命）
100+ mA	心颤（通常致命）
4+ Amps	心脏麻痹
5+ Amps	皮肤和器官开始烧伤



电弧伤害

据统计，在所有的电伤害案例中，超过80%的烧伤或灼伤都由电弧直接或间接（电弧引起衣物燃烧）而造成。高等级电弧电弧温度可高达19,427°C (35,000°F) - 是太阳表面温度的4倍。电弧伤害范围高达3米甚至3米以上，会对人体造成致命伤害。每年都有2000-人以上以为严重烧伤被送到烧伤中心治疗。

HRC2电弧防护装备

HRC2 Arc Flash Protection Equipment



订货号 Ref. : AS1000HAT



订货号 Ref. : AS1000FS



订货号 Ref. : SKJP11/M

防电弧头盔/面屏

- 加下颌杯ATPV值达到10cal/cm²，不加下颌杯ATPV为8cal/cm²。
- 视野范围75" x 20"
- AS1000HAT防电弧头盔，面屏为浅色
- 工业中 好的70%透视力(VLT)
- 可吸收>99.9%的有害紫外线辐射
- 符合ASTMF2178 规定
- 10 cal/cm² ATPV rating when used with the included chin cup
- 8 cal/cm² without the chin cup
- 7.5" x 20" viewing area
- 70% visual light transmission (VLT) Best in the Industry
- Absorbs >99.9% of harmful UV radiation
- Tested to ASTM F2178 Specifications

PRO-WEAR™防电弧夹克罩裤套件

8 & 12cal/cm²电弧防护套件

Salisbury PRO-WEAR™ 防电弧套件包括8 或 12cal/cm²防电弧头盔、夹克、罩裤，以及安全眼睛和存储包。提供从头到脚的HRC2级防护。

8 & 12cal/cm² Arc Flash Protection Kits

Salisbury PRO-WEAR™ Arc Flash Protection Jacket Kits and Overpants Kits are clothing kits containing an arc flash jacket with hood in an ATPV rating of either 8 cal/cm² or 12 cal/cm², an AS1000HAT, SKBAG and safety glasses. Appropriate ATPV rated overpants are included with SKJP kits.

The SKJP kits provide more protection and comfort than a lab coat and legging solution. These kits provide maximum head-to-toe HRC 2 Protection.

订货号 Ref.	产品 Product	尺码 Sizes
AS1000HAT	防电弧头盔	-
SKJP11	12cal/cm ² 电弧防护套件	S,M,L
SKJP8	8cal/cm ² 电弧防护套件	S,M,L

HRC4电弧防护装备

HRC4 Arc Flash Protection Equipment



40 CAL/CM2 HRC 4

40cal/cm²电弧防护套件

此Salisbury PRO-WEAR™电弧防护装备套件的ATPV®40 cal/cm²。这个套件包括电弧防护上衣，背带裤，PRO-HOOD，防电弧头罩，储存包和安全眼镜。防护服有S,M,L等尺码备选。这些套件都达到了标准NFPA 70E危害风险分级(HRC)4级的相关要求。

40cal/cm² Arc Flash Protection Kits

Salisbury PRO-WEAR™ Arc Flash Personal Protection Equipment Kits are available in an ATPV rating of 40 cal/cm². This kit contains an arc flash coat, bib overalls, PRO-HOOD™, electrical insulating rubber gloves, leather protector gloves, glove bag, SKBAG, and safety glasses. These kits meet NFPA 70E-2004 as Hazard Risk Category 4.

40 CAL/CM² 的PPE组合套件产品型号表

	ATPV等级 Cal/m ²	外衣尺码	HRC
SK	40	S,M,L,XL	4
例如:			
SK	40	L	4

例如:

SK40L是一个大的服装套件包，包括1个ATPV等级为40cal/m²的夹克，背带裤，PRO-HOOD，安全帽，安全眼镜和储存包。



电工绝缘手套 Insulating Gloves

天然乳胶电工绝缘手套 ELECTROSOFT LATEX GLOVES



天然乳胶卷边绝缘手套 天然乳胶切边绝缘手套

Electrosoft天然乳胶电工绝缘手套，分为切边和卷边两个系列以供客户选择

- 供应从00级到4级的电工绝缘手套，适用于从500伏至36,000伏的工作电压范围。
- 天然乳胶绝缘手套必须与相应的外用皮手套配合使用，以提供良好的机械抗力。
- 卷边手套内外双色，即米色外层和黑色内层，能立即辨别手套是否受损。

Electrosoft Latex gloves can be supplied with either rolled or cut edges, depending on user requirements.

- A full range of Electrosoft gloves is available from Class 00 to Class 4, for working voltages from 500V up to 36,000V.
- Non-supported latex insulating gloves must be worn in conjunction with a suitable leather overglove to provide mechanical protection.
- Rolled edge gloves are two-tone, comprising a beige interior and a black exterior to allow any damage to the glove to be identified immediately.

绝缘手套外用防护手套 OVERGLOVE



绝缘手套外用防护手套
OVERGLOVE

Electrosoft 电工绝缘手套外用手套。

- 电工绝缘手套外用手套用来配合 Electrosoft天然乳胶电工手套使用，用于防护可能出现的切割和撕裂危害
- 该产品有二个等级，能够配合从00级到3级的电工绝缘手套使用
- 产品由防水牛皮制成，内为硅胶衬里
- 厚度：1.1 毫米
- 颜色：米色

Electrosoft Overgloves.

- Electrosoft latex gloves must be used with leather overgloves to afford protection from risks of cutting or tearing
- Overglove come in two different types, for low voltage, medium voltage and high voltage
- Water repellent, belly cowgrain leather glove
- 1.1mm thick
- Color: beige

订货号 Ref.	产品 Product	EN 60-903 类别 Category	长度 Length	尺码 Sizes	EN 388 a b c d	
20 919 03	天然乳胶切边绝缘手套，工作电压500伏	00级	AZC	360毫米	9 和 10	
20 919 07	天然乳胶切边绝缘手套，工作电压1000伏	0级	RC	360毫米	9 和 10	
20 919 12	天然乳胶切边绝缘手套，工作电压7500伏	1级	RC	360毫米	9 和 10	
20 919 21	天然乳胶切边绝缘手套，工作电压17000伏	2级	RC	360毫米	9 和 10	
20 919 31	天然乳胶切边绝缘手套，工作电压26500伏	3级	RC	360毫米	9 和 10	
20 919 41	天然乳胶切边绝缘手套，工作电压36000伏	4级	AZC	410毫米	10 和 11	
20 919 08	天然乳胶卷边绝缘手套，工作电压1000伏	0级	RC	360毫米	8 到 10	
20 919 13	天然乳胶卷边绝缘手套，工作电压7500伏	1级	RC	410毫米	8 到 10	
20 919 22	天然乳胶卷边绝缘手套，工作电压17000伏	2级	RC	410毫米	8 到 10	
20 128 98	绝缘手套外用防护手套(中低压)00级/0级/1级				8 到 10	2 1 2 1
20 128 99	绝缘手套外用防护手套(高压)2级/3级				8 到 11	2 1 2 1

复合材质电工绝缘手套 ELECTROSOFT COMPOSITE GLOVES



复合材质电工绝缘手套
ELECTROSOFT COMPOSITE GLOVES

Electrosoft 复合材质电工绝缘手套，无须佩戴外用防护手套

- 由天然乳胶外敷氯丁橡胶制成，机械抗力及舒适性俱佳、防护水平高。
- 特别适用于潮湿和多油脂环境，防护电压可高达17 000 V。
- 可有效防护短路电弧。
- 0级手套内表面喷高密度棉绒，柔软吸汗，穿戴舒适方便。
- 外表面图纹确保手套在潮湿环境下，特别是室外作业中有良好的防滑性能。

Electrosoft Composite gloves can be used without leather overglove.

- Manufactured from a natural latex base covered with an outer layer of polychloroprene that combines mechanical resistance and comfort with a high protection level.
- Manufacturing technology: produces a supple glove ideal for work with electrical currents up to 17 000 volts, in damp or greasy conditions.
- Short circuit electric arc protection: the glove material structure exhibits excellent characteristics in case of short circuit electric arc.
- Cotton flock interior for Class 0. Putting on and taking off the glove is effortless. The softness of the cotton combined with its perspiration absorption properties significantly increases wearer comfort.
- Patterned finished: good grip in damp conditions; particularly useful for outdoor work.

订货号 Ref.	产品 Product	EN 60-903 	类别 Category	长度 Length	尺码 Sizes
20 920 15	复合材质绝缘手套，工作电压1000伏	0级	RC	360毫米	8 到 10
20 920 17	复合材质绝缘手套，工作电压7500伏	1级	RC	410毫米	8 到 10
20 920 27	复合材质绝缘手套，工作电压17000伏	2级	RC	410毫米	8 到 10



头部防护
手部防护
身体防护
足部防护

Head Protection
Hand Protection
Body Protection
Foot Protection

177
177
179
180

消防救援防护

Fire & Rescue Protection

消防员在执行任务中需要应对各种复杂而苛刻的环境，所以消防员必须配备从头到脚并具高等级防护能力的个人防护产品。

The fire fighters have to face all kinds of hostile environments in the task. So it is necessary to arm them from head to toe with high quality PPE.

消防服主要测试指标：

- **热防护值 (TPP)** 透过织物，引起二级烧伤的能量；热防护值越高，织物的热防护性能就越好。
- **耐静水压** 消防服能够抵御的大水压冲击；如果受到静水压冲击后，一旦发生渗漏会间接提高消防员的核身体温，因此耐静水压直接影响消防服的性能。
- **织物撕破强力** 在服装穿着过程中，织物的某一部分受到集中的负荷，致使经纱或纬纱受到最大负荷而撕裂，织物抵抗撕裂最大能力称为撕裂强力。

	标准号	热防护性能 (TPP)	织物撕破强力	耐静水压
美国标准	NFPA 1971-2007	≥ 35	外层 / 领子衬里: ≥ 100N 防水透气层 / 隔热层: ≥ 22N	防水透气层 (水洗 5 次后): ≥ 175kPa
中国标准	GA 10-2002	≥ 28	外层 (水洗 5 次后): ≥ 100N	防水透气层 (水洗 25 次后): ≥ 50kPa
欧洲标准	EN 469-2010	Level 1: 18 Level 2: 26	外层: ≥ 25N	防水透气层及接缝试样 (5 次水洗后): Level1: < 20kPa Level2: ≥ 20kPa

北美消防服 品牌 Morning Pride™ 现已加入 Honeywell，拥有多项设计专利，具有卓越的防护及舒适性能。

Morning Pride -The No.1 band in North America fire industrial has a lot of patents which can offer the products both comfort and high protective performance.

为消防人员定制的专业个人防护装备 (Firefighter PPE)

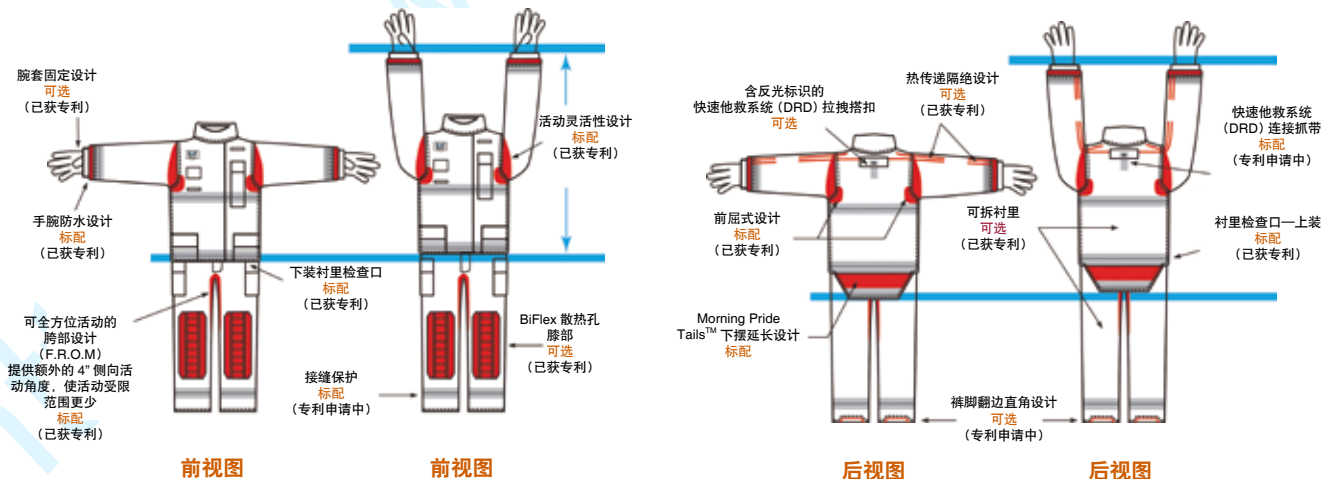

- 人工学动力设计 标配 (已获专利)
- 透气阻燃标签 标配 (专利申请中)
- 抗血源性病原体 (BPR) 的裤子式样 可选 (已获专利)
- 先进的条形码跟踪防护系统 (APT) 标配 (版权所有)

凭借我们的袖套专利设计，实现了全方位的上臂运动。这意味着活动所受阻力更低、上衣抬起范围少、袖套回缩距离更短以及上臂伸展范围大——仅会抬起 4" 范围或防护性能优于原设计 229%。

头部防护

Head Protection



订货号 Ref. : HT-LF2-BPR

Lite Force Plus消防战斗头盔 Lite Force Plus Modern Helmet

- 符合美国NFPA 1971-2007标准，适用于消防员进入火场执行灭火工作。采用专利材料FYR玻璃纤维，防穿刺能力比普通消防头盔高42%。高强度外壳使得头盔无需内部冲击层，有效减轻使用者头部负重感。NFPA 1971面屏，带有Postman滑扣的Nomex®速棘下颏带，8点加衬垫的棘齿帽托悬挂环。
- Strongest Shell on the Market. FYR-Glass Technology. High Heat Performance. Low Ride, Better Fit, Low Center of Gravity. More Sizes, More Adjustability. Bull Dog Edge Beading. Comfortable and Easy to Replace Suspension Protected Suspension Straps Rugged and Dependable Securely Attached Ear Covers Goggle Garage Option Large Hang-up Loop EZ Quick Attach Goggles EZ Change Chinstrap Lightweight Perfect Air Mask Fit Built In Goggle Retention NFPA 1971, 2007 Edition and ANSI Z87.1 CERTIFIED EZ-Flips.



订货号 Ref. : HT-BF2-Prox(BPR)

Proximity消防隔热头盔 Proximity Plus Helmet Lite Force with BPR

- 符合美国NFPA 1971-2007标准，采用FYR高强度外壳，金色耐高温涂层面屏4" x 0.110"，铝涂层披肩，适用于消防员在高辐射热的火场外执行灭火工作
- Shell Material: FYR-Glass Ear Covers: Aluminized Pb® W.L.Gore Moisture Barrier, Thermal Liner Chinstraps: Nomex® Quick Postman Slide Eye/Face Protection: Gold Coat 6" x .130" Trim: N/A Both Models Inherently Provide Bloodborne Pathogen Resistant Level of Protection NFPA 1971, 2007 Edition Certified.



订货号 Ref. : UT-UHD

抢险救援头盔 Technical Rescue Helmet

- 产品符合美国NFPA 1951-2007标准，采用FYR高强度外壳，使头盔不再需要额外的缓冲层，减轻了重量。帽檐有适配器，可安装各类面屏及护目镜；安装方便，无需任何工具。帽衬多处采用人体工程学设计，并且使用柔软的材料，提高佩带舒适性。
- FYG-Glass technology makes the strongest shell on the Market, and renders an impact cap unnecessary.
- Low Ride, Better Fit, Low Center of Gravity. Ear cover, Eye and face protection and other accessories are easy to be installed without any tool. Comfortable ergonomic suspension design. Meets NFPA 1971, 2007 Edition.

手部防护

Hand Protection



订货号 Ref. : GL-7500

GL-7500消防战斗手套 GL-7500 Structural Glove

- 符合美国NFPA 1971-2007标准，隔热牛皮外层，聚亚安酯防潮隔层，SEF（自熄羊毛）隔热衬里，符合人体工学的展开式翼状拇指设计，内侧皮制设计，弹性腕带提供加长护腕保护。尺码S, M, L, XL可供选择。
- Thermo Cowhide Outer Shell, Moisture Barrier: Polyurethane, Thermal LinerSEF, Pattern: 2-D, Thumb: Wing, Cuff: 2-ply Nomex® Spandex Wristlet with Leather Pull Tab Level of Bloodborne Pathogen Protection: HNO, Certification: NFPA 1971



订货号 Ref. : GL-SGKCG

GL-SGKCG消防战斗手套 GL-SGKCG Structural Glove

- 袋鼠皮材质的手背
- Crosstech® 防潮隔层
- Kevlar®/ Nomex® 衬里
- 真正的3D立体手型设计,
- 错列缝线样式
- 气泡型弹性手指以及热传递隔绝设计
- Air Spacer™ 结构隔绝热空气流通, 相比传统结构更利于热防护
- 翼状手指
- 长袖口设计
- 认证: NFPA 1971, 2007版本
- Kangaroo Back
- Digiroom™ High Grip Palm and Fingers
- Crosstech® Moisture Barrier
- Kevlar®/Nomex® Lining
- Bubble-Flex Finger and Knuckles with Dead Air
- Spacer Ridges
- Air Spacer™ Thermal Architecture Traps Air for Thermal Protection without Traditional Bulk
- Wing Thumb
- Gauntlet Cuff
- NFPA 1971, 2007 Edition



订货号 Ref. : GL-9500

GL-9500消防战斗手套 GL-9500 Structural Glove

- 袋鼠皮材质的手掌, 麋鹿手背
- Crosstech® 防潮隔层
- Kevlar®/ Nomex® 衬里
- 双层Nomex®
- 弹性腕带和内
- 侧皮制设计
- 认证: NFPA1971, 2007版本, NFPA 1951, 2007版本, 技术救援和恢复, 军用
- Kangaroo Palm, Elk Back Outer Shell
- Crosstech® Moisture Barrier
- Kevlar®/Nomex® Lining
- Wing Thumb
- 2-ply Nomex® Spandex Wristlet w/Leather Pull Tab Cuff
- NFPA 1971, 2007 Edition
- NFPA 1951, 2007 Edition Technical Rescue and Recovery, Utility



订货号 Ref. : GL-BPR-RGA

GL-BPR-RGA消防隔热手套 GL-BPR-RGA Proximity Glove

- 符合美国NFPA 1971-2007标准, Pbi™ 镀铝® / Twaron格子布皮制长手套袖口, 麋鹿皮手掌设计, Crosstech®防水透气层, SEF (自熄羊毛) 隔热衬里, 符合人体工学的立体3D裁剪和展开式翼状拇指设计, 适用于消防员在高辐射热的火场外执行灭火工作。尺码 S, M, L, XL可供选择。
- Outer Shell : Aluminized Pbi®/Twaron/Rip Stop/Elk. Moisture Barrier: Crosstech® Thermal LinerSEF, Pattern: 3-D, Thumb: Wing, Cuff: Gauntlet, Level of Bloodborne Pathogen Protection: BPR, Certification: NFPA 1971



订货号 Ref. : FG-1000

FG-1000型消防员灭火防护服 FG-1000 Structural Apparel

- FG-1000消防服符合GA10-2002标准，采用高性能织物和人体工学设计，确保消防员在进入火场可以高效执行任务并不受火焰和高温的伤害。外层为Nomex3A，防水透气层采用Nomex E89/ PTFE，隔热层为Nomex / Kevlar，舒适层 Nomex / FR Viscose。可拆卸内衬，皮质袖口和裤管等一系列设计，让服装更易维护并耐用。尺码：S, M, L, XL, XXL
- Meets GA10-2002. NomexIIIA outer shell, Nomex E89/ PTFE Moisture Barrier, Nomex / Kevlar thermal liner and Nomex / FR Viscose. Detachable liner makes maintenance easier and leather cuff provides better durability. Size:S,M,L,XL,XXL



订货号 Ref. : RNG-3400

Ranger 3400 消防灭火战斗防护服 Ranger 3400 Structural Apparel

- 符合美国NFPA 1971-2007标准，由高性能阻燃材料制成，分为Kevlar®/Nomex®-外层, Aralite/Nomex®隔热内层和防水透气层，适用于消防员进入火场执行灭火工作。背后加长的燕尾服式专利设计，提供更安全保护。可拆卸内衬，皮质袖口和裤管等一系列设计，让服装更易维护和耐用。尺码可定制。
- Meets NFPA 1971-2007. 7.0 Kevlar®/Nomex®outer shell, Aralite/Nomex®Moisture Barrier and thermal liner. Patented Tails design gives safer solution. Detachable liner makes maintenance easier and leather cuff provides better durability. Sizes are customized.



订货号 Ref. : 7602

消防隔热防护服 Morning Pride Proximity

- 符合美国NFPA 1971-2007标准，由高性能阻燃材料制成，分为Pbi™ 镀铝外层，Nomex® 隔热内层和Crosstech®防水透气层，适用于消防员在高辐射热的火场外执行灭火工作。尺码可定制。
- Collar Innermost Layer - Pbi™/Kevlar® Standard Chinstrap Innermost Layer - Pbi™/Kevlar® Standard Coat and Pant Cuffs - Pbi™/Kevlar® Standard Coat Storm Flap Innermost Layer - Black Nomex® Coat Inner Front Facings - Match the Garment liner . Pant Fly Inner Lining - Match the Garment Liner.

足部防护

Foot Protection



订货号 Ref. : 3104

3104消防战斗靴

Ranger Traditional fit

- 符合美国 NFPA 1971-2007标准。16"高，传统贴合款，钢包头和钢底板，靴头部耐磨和后跟加强设计，羊毛内底，羊毛衬里，Sure-Loc™ 白色防滑鞋底。尺码5-13。
- Traditional Fit Construction, Wool felt midsole, Durable toe cap and foxing, Wool felt lining, Steel bottom plate, toe, and shank, Extra heel reinforcement, Calendered outsole APT barcoded .



订货号 Ref. : 3009

3009消防战斗靴

3009 Structural Boots

- 符合美国 NFPA 1971-2007标准。14"高，皮革Bunker款，采用固特异橡胶镶边，重型军用AB皮革，Vibram®密集缝合，凸型边缘鞋底，Cambrelle®衬里，100%Kevlar®隔热内衬，Crosstech®防水透气层，钢包头，护腿板，快拉式鞋带，回火钢垫片，不锈钢底板。尺码5-13。
- NFPA 1971, 2007 edition, Goodyear Welt construction, Premium Full Grain Military AB leather, Full Crosstech® moisture barrier bootie with 7.5 oz 100% virgin Kevlar® felt thermal barrier and Cambrelle® fabric liner, Vibram® lug sole, Silicone impregnated leather toe cap, Oblique steel toe, bottom plate and ladder shank, Thermoplastic heel counter. Size:5-13.



订货号 Ref. : RJX

消防战斗靴

Structura Boots of GA Standard

- 由性能优异的复合阻燃橡胶材料制成。100%防水
- 舒适的足部支撑结构，长时间穿着有效减轻消防员的负担
- 钢包头及钢底板，以防砸、防穿刺
- 最大耐受电压达5000V，漏电电流小于3MA
- 卓越的隔热性能，优于GA6-2004标准三倍
- 独特鞋筒、提环及后跟踢块设计，便于携带、迅速穿脱
- 高亮度反光标识，易于辨认
- 符合GA 6-2004标准，通过国家消防装备质量监督检测中心检测
- 尺码：6-11
- Waterproof flame-resistant compound rubber boots
- Ultra-composite shanks reinforce construction and support the feet.
- Steel toe & midsole help to prevent from impaction and compression, puncture hazard.
- Meets insulation requirements of GA6-2004
- Excellent heat resistance performance, 3 times better than the requirement of GA6-2004
- Unique design of boots upper, pull-up loops and kick-off lugs on heel to provide easy of carry and donning.
- High visual trims on boots offer great reflection to others.



订货号 Ref. : 6211

6211消防隔热救援靴

6211 ARFF Bunker Boots

- Silver Shield 橡胶
- 夜间安全反光条
- SAFE-TOE® 钢包头
- 钢底板
- 羊毛毡鞋底内层
- 支撑钢垫片
- Nomex® 衬里
- 鞋跟耐磨损设计
- 黑色凸型边缘鞋底
- NFPA 1971, 2007版本 FFA-AC 150/5210-14A
- Rugged reinforced Proximity boot
- Durable heat & penetration Nomex® barrier
- Heavy duty construction with rugged pull-up loops and reinforced top. Extra layers in heel and toe increase durability, support and protection
- Black lug outsoles provide a stable base for balance and traction in low light conditions
- Flex Shield steel bottom plate meets NFPA, ASTM, and CSA standards for sole puncture resistance
- SAFE-TOE® steel toe cap and shank
- Wool felt midsole
- NFPA 1971, 2007 edition for Proximity and FFA-AC 150/5210-14A



索引 Index

听力防护系列
Hearing Protection



1 - 14

订货号 Ref.	名称描述 Description	页码 Page
1000107	Bilsom 303 带线耳塞 小号 29NRR Bilsom 303 Earplug Corded	3
1000106	Bilsom 303 带线耳塞 大号 29NRR Bilsom 303 Earplug Corded	3
1005074	Bilsom 303 不带线耳塞 小号 29NRR Bilsom 303 Earplug Corded	3
1005073	Bilsom 303 不带线耳塞 大号 29NRR Bilsom 303 Earplug Corded	3
1006187	Bilsom 303 耳塞填充包 (200副/袋, 用于LS-400 分配器) Bilsom 303 Earplug (200 pairs/bag, For LS-400 dispenser)	6
1010376	Impact 电子耳罩 23NRR IMPACT earmuff 23NRR	14
1010421	Mach1 红色 经济型耳罩 18NRR Mach1 Red Economic Earmuff 18NRR	11
1010632	ImpactH 电子耳罩 21NRR IMPACT earmuff for helmet 21NRR	14
1010922	Leightning (L1) 海绵内衬 舒适型 耳罩 25NRR Leightning (L1) Earmuff 25NRR	8
1010923	Leightning (L2) 海绵内衬 舒适型 耳罩 27NRR Leightning (L2) Earmuff 27NRR	8
1010924	Leightning (L3) 海绵内衬 舒适型 耳罩 30NRR Leightning (L3) Earmuff 30NRR	8
1010925	Viking 1 可旋转头箍 多功能耳罩 25NRR Viking 1 Multiple-Position Band Earmuff 25NRR	12
1010926	Viking 2 可旋转头箍 多功能耳罩 27NRR Viking 2 Multiple-Position Band Earmuff 27NRR	12
1010927	Viking 3 可旋转头箍 多功能耳罩 29NRR Viking 3 Multiple-Position Band Earmuff 29NRR	12
1010928	Thunder (T1) 经济型耳罩 26NRR Thunder (T1) Economic Earmuff 26NRR	10
1010929	Thunder (T2) 耳罩 28NRR Thunder (T2) Earmuff 28NRR	10
1010970	Thunder (T3) 耳罩 30NRR Thunder (T3) Earmuff 30NRR	10
1011142	Clarity 1 人声传递型 耳罩 20NRR Clarity 1 Earmuff 20NRR	13

订货号 Ref.	名称描述 Description	页码 Page
1011143	Clarity 1 (C1F) 可折叠, 人声传递型 耳罩 20NRR Clarity 1 (C1F) Folding Earmuff 20NRR	14
1011145	Clarity 2 可旋转头箍 人声传递型 耳罩 23NRR Clarity 2 Multiple-Position Band Earmuff 23NRR	13
1011146	Clarity 3 人声传递型 耳罩 27NRR Clarity 3 Earmuff 27NRR	13
1011242	Clarity 1 (C1H) 安全帽型 耳罩 20NRR Clarity 1 (C1H) Hardhat Earmuff 20NRR	14
1011243	Clarity 3 (C3H) 安全帽型 耳罩 25NRR Clarity 3 (C3H) Hardhat Earmuff 25NRR	14
1011600	Thunder (T1F) 可折叠耳罩 25NRR Thunder (T1F) Folding Earmuff 25NRR	10
1011601	Thunder (T1H) 安全帽 耳罩 23NRR Thunder (T1H) Earmuff for Hardhat 23NRR	11
1011602	Thunder (T2H) 安全帽耳罩 25NRR Thunder (T2H) Earmuff for Hardhat 25NRR	11
1011603	Thunder (T3H) 安全帽耳罩 27NRR Thunder (T3H) Earmuff for Hardhat 27NRR	11
1011991	Leightning (L1H) 安全帽 耳罩 23NRR Leightning (L1H) Earmuff for Hardhat 23NRR	9
1011992	Leightning (L2H) 安全帽 耳罩 25NRR Leightning (L2H) Earmuff for Hardhat 25NRR	9
1011993	Leightning (L3H) 安全帽 耳罩 27NRR Leightning (L3H) Earmuff for Hardhat 27NRR	9
1011994	Leightning (L1N) 颈带型 耳罩 25NRR Leightning (L1N) NeckBand Earmuff 25NRR	9
1011995	Leightning (L2N) 颈带型 耳罩 26NRR Leightning (L2N) NeckBand Earmuff 26NRR	9
1011996	Leightning (L3N) 颈带型 耳罩 28NRR Leightning (L3N) NeckBand Earmuff 28NRR	9
1011997	Leightning (L2F) 折叠型 耳罩 27NRR Leightning (L2F) Folding Earmuff 27NRR	8
1017574	Bilsom 303 耳塞填充包 (500副/盒, 用于LS-500 分配器) Bilsom 303 Earplug (500 pairs/pack, For LS-500 dispenser)	6
QD30	Quiet 可重复使用带线耳塞 26NRR Quiet Reuseable Earplug Corded (Red) 26NRR	5
FUS30	Fusion 带线圣诞树耳塞 (大号 附简易小盒) 27NRR Fusion reuseable plug corded with box (large) 27NRR	5
FUS30S	Fusion 带线圣诞树耳塞 (小号 附简易小盒) 27NRR Fusion reuseable plug corded with box (small) 27NRR	5
LL-1	Laser Lite 耳塞 32 NRR Laser Lite Earplug without cord 32 NRR	4
LL-30	Laser Lite 带线耳塞 32 NRR Laser Lite Corded Earplug 32 NRR	4
LL-LS4	Laser Lite 耳塞 填充包 (200副/袋, 用于LS-400 分配器) Laser Lite Earplug 32 NRR (For LS400 dispenser)	6

订货号 Ref.	名称描述 Description	页码 Page
LPF-1-D	Max Lite 耳塞填充包 (500副/盒, 用于LS-500 分配器) Max Lite Earplug (500 pairs/pack, For LS-500 dispenser)	6
LS-400	经济型耳塞分配器 Earplug dispenser L-400	6
LS-500	金属耳塞分配器 Earplug dispenser L400	6
MAX-1	Max 耳塞 33 NRR MAX Earplug without Cord	3
MAX-1-D	Max 耳塞 填充包 (500副/盒, 用于LS-500 分配器) MAX Earplug without Cord (For LS500 dispenser)	6
MAX-30	Max 带线耳塞 33NRR MAX Earplug Corded	3
MAX-LS4	Max 耳塞 填充包 (200副/袋, 用于LS-400 分配器) MAX Earplug without Cord (200 pairs / bag, For LS400 dispenser)	6
MTX-1-OR	Matrix 不带线耳塞 桔红色 29NRR Matrix Orange Earplug without cord 29NRR	4
MTX-1-OR-D	Matrix 耳塞填充包 (500副/盒, 用于LS-500 分配器) Matrix Earplug (500 pairs/pack, For LS-500 dispenser)	6
MTX-30-OR	Matrix 带线耳塞 桔红色 23NRR Matrix Orange Corded Earplug 23NRR	4
SMF-30	SmartFit 可重复使用带线耳塞 (附小盒) 25NRR SmartFit Reusable Earplug 25NRR	5
LPF-1-O-CH	Max-Lite® 耳塞 30 NRR Max-Lite® Earplug without Cord	4
LPF-30-O-CH	Max-Lite® 带线耳塞 30NRR Max-Lite® Earplug Corded	4

眼脸部防护系列
Eye & Face Protection



15 - 28

订货号 Ref.	名称描述 Description	页码 Page
2210	墙式洗眼器 Eyewash wall mount	27
2220	落地式洗眼器 Eye Washer	27
4220	复合式洗眼器带冲淋 Shower & Eye Wash Station	27
100001	VisiOTG-A 透明镜片 访客眼镜 VisiOTG-A Clear Lens	18
100002	VisiOTG-A 透明镜片 防雾 访客眼镜 VisiOTG-A Clear Lens Fog-Ban	18
100020	VL1-A 透明镜片 防雾眼镜 VL1-A Clear Lens Fog-Ban	20

订货号 Ref.	名称描述 Description	页码 Page
100021	VL1-A 灰色镜片 防雾眼镜 VL1-A TSR GREY Lens Fog-Ban	20
100022	VL1-A Silver 银灰色镜片 防护眼镜 VL1-A Silver Mirror Lens HC	20
100100	S200A 透明镜片 防雾眼镜 (蓝色镜框) S200A Clear Lens Anti-Fog (Blue Frame)	18
100110	S200A 透明镜片 防雾眼镜 (黑色镜框) S200A Clear Lens Anti-Fog (Black Frame)	18
100111	S200A 灰色镜片 防雾眼镜 (黑色镜框) S200A Grey Lens Anti-Fog (Black Frame)	18
100200	S200A 透明镜片 耐刮擦眼镜 (蓝色镜框) S200A Clear Lens Hard Coating (Blue Frame)	18
100210	S200A 透明镜片 耐刮擦眼镜 (黑色镜框) S200A Clear Lens Hard Coating (Black Frame)	18
100211	S200A 灰色镜片 耐刮擦眼镜 (黑色镜框) S200A Grey Lens Hard Coating (Black Frame)	18
1002302	面屏支架(安全帽支架) Helmet-mounted Visor Holder (Plastic) (SA660)	23
1002312	透明聚碳酸防护面屏(与1002302配合使用) Clear PC Visor (230mm)	23
1002325	镀金防护面屏(与1002302配合使用) Gold-Coated Abrasion-Resistant Polycarbonate (230mm) (SV9PGFH)	23
1002330	聚醋酸酯绿色5#暗度防护面屏(与1002302配合使用) SW9A/5W Green Shade 5	23
1002341	Sperian防护面屏支架(含前额保护) Browguard With Ratchet Headband (CB20)	23
1002353	透明聚碳酸防护面屏(与1002341配合使用) Clear PC Visor (200mm) (CV83P)	23
1002360	透明聚醋酸酯防化防护面屏(与1002341配合使用) Clear Acetate Visor (200mm) (CV84A)	23
1002781	Millennia 黑色镜框 透明镜片 防雾 眼镜 Millennia eyewear(black frame/clear lense/fogban)	19
1002782	Millennia Classic 防护眼镜黑色镜框,灰色防雾镜片 Millennia black fram grey lens fog ban	19
1002783	Millennia 蓝色镜框 透明镜片 防雾 眼镜 Millennia eyewear(blue frame/clear lense/fogban)	19
1004947	OP-Tema 黑色可调节角度及长度镜框 透明镜片 防雾 眼镜 OP-Tema eyewear(black frame/clear lense/fogban)	19
1005212	Millennia 黑色镜框 黄色镜片 防雾眼镜 Millennia eyewear(black frame/yellow HDL lense/fogban)	19
1005985	Millennia sport 黑色镜框 透明镜片 防雾 眼镜 Millennia sport eyewear(black frame/clear lense/fogban)	20
1005986	Millennia sport 黑色镜框 灰色镜片 防雾 眼镜 Millennia sport eyewear(black frame/grey TSR lense/fogban)	20
1006193	V-MAXX 聚碳酸酯防雾护目镜 V-MAXX Goggle Indirect vent Anti-Fog Elastic	22

订货号 Ref.	名称描述 Description	页码 Page
1006405	Millennia Classic 焊接防护眼镜黑色镜框,3号暗度镜片 Millennia welding IR3	19
1006406	Millennia Classic焊接防护眼镜黑色镜框,5号暗度镜片 MILLENNIA welding IR5	19
1007506	V-MAXX 防化护目镜 (防雾镜片, 大视角, 橡胶头带) V-MAXX GOGGLE	22
1008111	V-MAXX聚碳酸酯防雾焊接用5号暗度护目镜 V-MAXX Fog Ban Welding IR5	22
1011378	防雾产品专用清洁液喷剂(500毫升) clear 500ml spary bottle	28
1011379	防雾产品专用清洁纸巾(500抽) clear lens tissue	28
1011380	防雾产品清洁套装(1瓶500ml喷剂,1500抽纸巾) clear disposable station	28
32-000100	便携式洗眼器I型(轻型,持续6分钟流量) Porta Stream I	25
32-000200	便携式洗眼器II型(大容量,持续15分钟流量) Porta Stream II	25
32-001060	便携式洗眼器推车 Universal Cart	26
32-001065-0000	洗眼器支架 Universal Eyewash Stand	26
32-001100	清水防腐剂 Eyesaline Preservative	25
32-001187	便携式紧急冲淋器(附携带拎包) Emergency Shower with Carry Bag	26
BD-173B	面屏头盔支架 Semi-Aluminum Bracket	24
BD-176B	半头盔面屏支架 Headgear	24
CP5004	面屏头盔支架 Semi-Aluminum Bracket	24
CP5007	面屏头盔支架 Semi-Aluminum Bracket	24
SE-173A	透明防护屏 付铝边 Clear Visor	24
A8150/40	透明防护屏 不带铝边 Clear Visor	24
SE-174A	绿色防护屏 Green Visor	24
110100	S600A 蓝色镜架 透明镜片 防雾眼镜 S600A Blue Frame Clear Lens Anti-Fog	17
110110	S600A 黑色镜架 透明镜片 防雾眼镜 S600A Black Frame Clear Lens Anti-Fog	17
110111	S600A 黑色镜架 灰色镜片 防雾眼镜 S600A Black Frame TSR Gray Lens Anti-Fog	17

订货号 Ref.	名称描述 Description	页码 Page
110200	S600A 蓝色镜架 透明镜片 耐刮擦眼镜 S600A Blue Frame Clear Lens Hard Coating	17
110210	S600A 黑色镜架 透明镜片 耐刮擦眼镜 S600A Black Frame Clear Lens Hard Coating	17
10 177 50	DuraMaxx蓝灰色镜身/透明PC镜片/布质头带/DuraStream涂层 DuraMaxx	21
10 177 51	DuraMaxx蓝灰色镜身/透明PC镜片/橡胶头带/DuraStream涂层 DuraMaxx	21
10 281 35	DuraMaxx透明PC镜片/DuraStream涂层 DuraMaxx	21
10 177 39	DuraMaxx蓝灰色镜身/IR5 PC镜片/橡胶头带/DuraStream涂层 DuraMaxx	21
10 281 40	DuraMaxxIR5 PC镜片/DuraStream涂层 DuraMaxx	21
10 057 71	套进式眼镜绳 Spectacle Cords	28
1005504	LG10 轻便型护目镜 LG10	22
BC86010000	Deluxe防护帽-低危险性防护帽。白色 Deluxe hard hat (white)	17
BC86020000	Deluxe防护帽-低危险性防护帽。黄色 Deluxe hard hat (yellow)	17
BC86030000	Deluxe防护帽-低危险性防护帽。橘黄色 Deluxe hard hat (orange)	17
BC86070000	Deluxe防护帽-低危险性防护帽。蓝色 Deluxe hard hat (blue)	17
BC86150000	Deluxe防护帽-低危险性防护帽。红色 Deluxe hard hat (red)	17
GC2000	护目镜夹 Goggle Clip	22

呼吸防护系列
Respiratory Protection

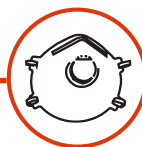

29 - 70

订货号 Ref.	名称描述 Description	页码 Page
100600	防护汞蒸汽和氯气，带ESLI寿命终点指示功能 Mercury vapor + Chlorine, with ESLI function	42
100800	综合气体防护滤盒 Multi-Contaminant	42
105005	P100 防尘过滤棉 P100 filter	42
105810	综合气体及防尘防护滤盒 Multi-Contaminant + P100 filter	42

订货号 Ref.	名称描述 Description	页码 Page
106010	N95防尘过滤棉 N95 filter	42
140174	滤棉支架 Retainer	42
311500	Premier系列硅胶半面罩(小号) Premier small silicone half mask	36
312500	Premier系列硅胶半面罩(中号) Premier medium silicone half mask	36
313500	Premier系列硅胶半面罩(大号) Premier large silicone half mask	36
752000	OPTI-FIT系列硅胶全面罩(小号) Optifit silicone full face mask(small)	38
762000	OPTI-FIT系列硅胶全面罩(中号) Optifit silicone full face mask(Medium)	38
772000	OPTI-FIT系列硅胶全面罩(大号) Optifit silicone full face mask(Medium)	38
1005584	5210 M/L 高性能防护口罩 5210 ML (FFP2 disposable mask without valve)	33
1005586	5211 M/L 高性能带阀防护口罩 5211 ML (FFP2 disposable mask with valve)	33
1005591	5140M/L-OV 高性能活性炭防护口罩 5140 ML (FFP1 and OV disposable mask without valve)	33
1015790	SuperOne N95 舒适型防护口罩 SuperOne NBW95 (N95 disposable mask without valve)	31
1015791	SuperOne N95 舒适型防护口罩(带阀) SuperOne NBW95 (N95 disposable mask with valve)	31
1710641	黄色全面罩 Cosmo Yellow	38
1710643	蓝色全面罩 Cosmo Blue	38
1715001	OPTI-FIT系列硅胶全面罩(小号) Optifit silicone full face mask(small)	39
1715011	OPTI-FIT系列硅胶全面罩(中号) Optifit silicone full face mask(Medium)	39
1715021	OPTI-FIT系列硅胶全面罩(大号) Optifit silicone full face mask(Medium)	39
1728500	EVAMASQUE 逃生过滤半面罩 (含过滤盒) EVAMASQUE half mask for escape (with filter)	67
1728555	EVAMASQUE 逃生过滤半面罩用滤盒 Filter for EVAMASQUE	67
1762983	MC95 流量调节器 MC95 flow controller	52
1781095	单罐全面罩防催泪瓦斯铝制过滤罐 Aluminum CS canister for full face mask	43
1783040	A2B2+P3 250型单罐全面罩有机气体及蒸气, 无机气体, 及防尘铝制过滤罐 A2B2+P3 250cc Aluminum canister for full face mask	43

订货号 Ref.	名称描述 Description	页码 Page
1783140	汞P3 单罐全面罩铝制滤罐 HG P3 Aluminum canister for full face mask	43
1784000	A2B2E2K2+P3 450型单罐全面罩综合铝制过滤罐 A2B2E2K2+P3 450cc Aluminum canister for full face mask	43
1785040	A2B2 250型单罐全面罩有机气体及蒸气, 无机气体铝制过滤罐 A2B2 250cc Aluminum canister for full face mask	43
1785622	A2B2E2K1 P3 NBC 450型, 单罐全面罩综合防恐铝制过滤罐 A2B2E2K1 P3 NBC 450cc Aluminum canister for full face mask	43
1786000	P3 颗粒单罐全面罩塑料过滤罐 P3 particulate filter for full face mask	43
1786200	碘, 放射性颗粒, 单罐全面罩铝制过滤罐 Iodine and raditional dust filter	43
B100100	有机气体防护滤盒 Survivair organci vapor	42
B100200	酸性气体防护滤盒 Acid vapor	42
B100300	有机及酸性气体防护滤盒 Oganic+Acid vapor	42
B100400	氨气、甲基胺气体防护滤盒 Ammonia Methylamine	42
B250000	2000系列半面罩(小号) 2000/small sillicone half mask	36
B260000	2000系列半面罩(中号) 2000/medium sillicone half mask	36
B270000	2000系列半面罩(大号) 2000/large sillicone half mask	36
B290	中号双滤盒半面罩 Protech Half mask (Medium size)	36
BC1005584	801 标准型防护口罩 801(N95 disposable mask without valve)	31
BC1182011	消防指挥员型空气呼吸器(挎包式) Eva Pack escaping SCBA	68
BC1182021	AUTOPACK 逃生呼吸器(碳瓶) Auto Pack escaping SCBA	68
BC1763525-4	DE4过滤站组合配置(供四人使用) Supplied Air (for four persons)	47
BC1763525-3	DE4过滤站组合配置(供三人使用) Supplied Air (for three persons)	47
BC1763525-2	DE4过滤站组合配置(供二人使用) Supplied Air (for two persons)	47
BC1763525-1	DE4过滤站组合配置(供一人使用) Supplied Air (for one persons)	47
BC1766010	移动小车全配型(含4个Luxfer 6.8L气瓶) Air trolley full equipped system (With 4 Luxfer 6.8L cylinders)	54
BC1766011	移动小车全配型(含4个国产6.8L气瓶) Air trolley full equipped system (With 4 local 6.8L cylinders)	54

订货号 Ref.	名称描述 Description	页码 Page
BC1766012	移动小车全配型 (含 4个Luxfer 9.0L气瓶) Air trolley full equipped system (With 4 Luxfer 9.0L cylinders)	54
BC1766013	移动小车标准型 (不含气瓶) Air trolley standard system (Without cylinder)	54
BC1766014	移动小车经济型 (不含气瓶) Air trolley basic system (Without cylinder)	54
BC1766015	移动小车经济型 (不锈钢车体, 不含气瓶) Air trolley basic system (stainless steel air trolley Without cylinder)	54
BC1766500	逃生系统升级套装 (用于经济型升级至标准型或全配型) Escape SCBA system for upgrade basic system to standard system or full equipped system	54
BC1788000	A2有机气体单罐全面罩塑料过滤罐 A2 250 cc plastic canister for full face mask	44
BC1788005	A2P3 250 cc 滤罐 B2P3 250 CC	44
BC1788010	B2无机气体单罐全面罩塑料过滤罐 B2 250 cc plastic canister for full face mask	44
BC1788015	B2P3 250 cc 滤罐 B2P3 250 CC	44
BC1788020	K2氨类衍生物,氨单罐全面罩塑料过滤罐 K2 250 cc plastic canister for full face mask	44
BC1788025	K2P3 250 cc 滤罐 B2P3 250 CC	44
BC1788070	A2B2P3有机,无机气体,颗粒单罐全面罩复合塑料过滤罐 A2B2P3 250 cc plastic canister for full face mask	44
BC1788075	A2B2有机,无机气体单罐全面罩复合塑料过滤罐 A2B2 250cc plastic canister for full face mask	44
BC1788150	A2B2E2K2有机,无机,酸性,氨类衍生物,氨,综合气体单罐全面罩塑料过滤罐 A2B2E2K2 450 cc plastic canister for full face mask	44
BC1788155	A2B2E2K2P3有机,无机,酸性,氨类衍生物,氨,颗粒单罐全面罩综合塑料过滤罐 A2B2E2K2P3 450 cc plastic canister for full face mask	44
BC1868427	C900 / C850 用 6.8L Luxfer 碳瓶 C900 / C850 6.8L Luxfer cylinder	62
BC1868527	C900 / C850 用 6.8L 国产碳瓶 C900 / C850 6.8L local carbon cylinder	62
1890327	C900 / C850 用 9L Luxfer 碳瓶 C900 / C850 9L Luxfer cylinder	62
BC1868427T	T8000 用 Luxfer 6.8L 气瓶 Luxfer 6.8L Cylinder	58
BC1890327T	T8000 用 Luxfer 9L 气瓶 Luxfer 9L Cylinder	58
F200	双滤盒半, 全面罩滤片 N95 particulate filter for half and full face mask	42
G100	G100 双滤盒半, 全面罩有机气体及蒸气(黑色)滤盒 G100 organic vapor filter for half and full face mask	42
G104	G104 双滤盒半, 全面罩酸性气体及蒸气(黄色)滤盒 G104 organic+Acid vapor filter for half and full face mask	42

订货号 Ref.	名称描述 Description	页码 Page
G106	G106双滤盒半, 全面罩氨、硫化氢(深绿色)滤盒 G106 Ammonia/Methylamine filter for half and full face mask	42
G110	G110双滤盒半, 全面罩(有机酸性气体及蒸气、氨、硫化氢(浅绿色)综合滤盒 G110 Multi contaminant filter for half and full face mask	42
SCBA105M	C900呼吸器PANO面罩6.8L Luxfer气瓶 C900 SCBA PANO mask 6.8L Luxfer cylinder	62
SCBA123M	C900呼吸器PANO面罩6.8L Luxfer气瓶带表 C900 SCBA PANO mask 6.8L cylinder (gauge)	62
SCBA124	C900呼吸器PANO面罩6.8L Luxfer双气瓶 C900 SCBA PANO mask double 6.8L cylinders	62
SCBA126	C900呼吸器PANO面罩9L Luxfer气瓶 C900 SCBA PANO mask 9L cylinder	62
SCBA205	C850呼吸器PANO面罩6.8L国产气瓶 C850 SCBA PANO mask 6.8L cylinder	62
SCBA215	C850呼吸器PANO面罩6.8L国产气瓶带表 C850 SCBA PANO mask 6.8L cylinder (gauge)	62
SCBA305	COUGAR 正压式空气呼吸器 45分钟 SURVIVAIR 原装碳瓶 COUGAR SCBA 45mins fully imported SURVIVAIR cylinder	63
SCBA325	Cougar 6.9L双面表瓶防自锁进口 Cougar SCBA 6.9L carbon cylinder (gauge locking wheel) total imported	63
SCBA345	COUGAR 正压式空气呼吸器 60分钟 SURVIVAIR 原装碳瓶 COUGAR SCBA 60 mins fully imported SURVIVAIR cylinder with locking wheel	63
SCBA805	T8000 标准呼吸器 (6.8L luxfer 气瓶, PANO 面罩) T8000 SCBA (6.8L Luxfer Cylinder, PANO Mask)	58
SCBA825	T8000 标准呼吸器 (6.8L luxfer 气瓶, Survivair 20/20plus 面罩) T8000 SCBA (6.8L Luxfer Cylinder, Survivair 20/20plus Mask)	58
SCBA809	T8000 标准呼吸器 (9L luxfer 气瓶, PANO 面罩) T8000 SCBA (9L Luxfer Cylinder, PANO Mask)	58
SCBA829	T8000 标准呼吸器 (9L luxfer 气瓶, Survivair 20/20plus 面罩) T8000 SCBA (9L Luxfer Cylinder, Survivair 20/20plus Mask)	58
SCBA805T	T8000 他救呼吸器 (6.8L luxfer 气瓶, PANO 面罩) T8000 SCBA with buddy breather (6.8L Luxfer Cylinder, PANO Mask)	58
SCBA825T	T8000 他救呼吸器 (6.8L luxfer 气瓶, Survivair 20/20plus 面罩) T8000 SCBA with buddy breather (6.8L Luxfer Cylinder, Survivair 20/20plus Mask)	58
SCBA809T	T8000 他救呼吸器 (9L luxfer 气瓶, PANO 面罩) T8000 SCBA with buddy breather (9L Luxfer Cylinder, PANO Mask)	58
SCBA829T	T8000 他救呼吸器 (9L luxfer 气瓶, Survivair 20/20plus 面罩) T8000 SCBA with buddy breather (9L Luxfer Cylinder, Survivair 20/20plus Mask)	58
5130N95	N95标准型口罩 N95 disposable mask	31
7130N95	N95舒适型口罩 大号/中号 N95 disposable mask M/L	32
7130N95S	N95舒适型口罩 小号 N95 disposable mask S	32
7140N95	N95舒适型口罩 大号/中号 N95 disposable mask M/L	32

订货号 Ref.	名称描述 Description	页码 Page
7140N95S	N95舒适型口罩 小号 N95 disposable mask S	32
8145P95	P95全密封型口罩 P95 disposable mask	32
4200M	N95标准款 大号/中号 N95 Standard M/L	34
4200S	N95标准款 小号 N95 Standard S	34
4200MW	N95焊接专用款 大号/中号 N95 for welding M/L	34
4200SW	N95焊接专用款 小号 N95 for welding S	34
7190N99	N99焊接专用款 N99 for welding	34
42N95	N95滤棉, CFR-1专用 N95 for CFR-1	34
42R95	R95滤棉, CFR-1专用 R95 for CFR-1	34
719009N99	N99滤棉, 7190N99专用 N99 for 7190N99	34
770030L	7700系列半面罩 大号 7700 series half mask L	35
770030M	7700系列半面罩 中号 7700 series half mask M	35
770030S	7700系列半面罩 小号 7700 series half mask S	35
550030L	5500系列半面罩 大号 5500 series half mask L	35
550030M	5500系列半面罩 中号 5500 series half mask M	35
550030S	5500系列半面罩 小号 5500 series half mask S	35
760008A	7600系列全面罩 大号/中号 7600 series full mask M/L	37
760008AS	7600系列全面罩 小号 7600 series full mask S	37
54001	5400系列全面罩 大号/中号 5400 series full mask M/L	37
54001S	5400系列全面罩 小号 5400 series full mask S	37
54301	5400系列全面罩 大号/中号 5400 series full mask M/L	39
54201	5400系列全面罩 大号/中号 5400 series full mask M/L	39
N75001	滤盒, 防护有机气体及蒸汽 Organic Vapors	40

订货号 Ref.	名称描述 Description	页码 Page
N75002	滤盒, 防护酸性气体 Acid gases	40
N75003	滤盒, 防护有机气体及蒸汽, 酸性气体 Organic Vapors + Acid gases	40
N75004	滤盒, 防护氨气及甲胺类碱性气体 Ammonia + Methylamine	40
N750052	滤盒, 防护汞蒸汽和氯气, 带ESLI寿命终点指示功能 Mercury vapor + Chlorine, with ESLI function	40
75SC	Defender多用滤盒, 防护多种气体, 如有机气体及蒸汽, 酸性气体, 氨气及甲胺类碱性气体和甲醛 Multi-use, including Organic Vapors, Acid gases, Ammonia, Methylamine and Formaldehyde	40
7581P100	滤盒, 防护有机气体及蒸汽, 颗粒物 Organic Vapors + particulates	40
7582P100	滤盒, 防护酸性气体, 颗粒物 Acid gases + particulates	40
7583P100	滤盒, 防护有机气体及蒸汽, 酸性气体, 颗粒物 Organic Vapors + Acid gases + particulates	40
7584P100	滤盒, 防护氨气及甲胺类碱性气体, 颗粒物 Ammonia + Methylamine + particulates	40
75852P100	滤盒, 防护汞蒸汽和氯气, 颗粒物, 带ESLI寿命终点指示功能 Mercury vapor + Chlorine + particulates, with ESLI function	40
75SCP100	Defender多用滤盒, 防护多种气体, 如有机气体及蒸汽, 酸性气体, 氨气及甲胺类碱性气体和甲醛, 颗粒物 Multi-use, including Organic Vapors, Acid gases, Ammonia, Methylamine and Formaldehyde + particulates	40
7506N95	N95滤棉 N95 filter	41
7531N95	N95滤棉组合 (含7506N95滤棉, N750027滤棉盖, N750015滤棉固定器) N95 filter set (including 7506 N95 filter, N750027 filter cover, N750015 filter holder)	41
7506N99	N99滤棉 N99 filter	41
7531N99	N99滤棉组合 (含7506N95滤棉, N750027滤棉盖, N750015滤棉固定器) N99 filter set (including 7506 N95 filter, N750027 filter cover, N750015 filter holder)	41
7506R95	R95滤棉 R95 filter	41
7580P100	P100滤棉 P100 filter	41
75FFP100	P100滤棉, 扁平式 P100 filter, flat shape	41
N750015	滤盒/滤棉固定底座 filter holder	41
N750027	滤盒/滤棉盖 (7506N95, 7506N99, 7506R95专用) filter cover (for 7506N95, 7506N99, 7506R95)	41
N750029	滤盒/滤棉盖 (750080P100专用) filter cover (for 750080P100)	41
N750035	滤盒/滤棉盖 (75FFP100专用) filter cover (for 75FFP100)	41
A168097	A2B2E2K2 有机和无机气体及蒸汽, 酸性气体, 氨及有机氨衍生物过滤罐 A2B2E2K2 Organic and inorganic gases and vapors, Acid gases, Ammonia	43

订货号 Ref.	名称描述 Description	页码 Page
A168103	A2B2P3 有机气体及蒸气, 无机气体, 颗粒物过滤罐 A2B2P3 Organic and inorganic gases and vapors + particulates	43
A168104	A2B2E2K2P3 有机和无机气体及蒸气, 酸性气体, 氨及有机氨衍生物, 颗粒物过滤罐 A2B2E2K2P3 Organic and inorganic gases and vapors, Acid gases, Ammonia + particulates	43
A150102-00	COMPACT AIR 系列卡口式接头电动送风系统 COMPACT AIR PAPR with bayonet connection	45
A150103-00	COMPACT AIR 系列螺口式接头电动送风系统 COMPACT AIR PAPR with threaded connection	45
A150140-00	COMPACT AIR 系列卡口式接头防暴电动送风系统 COMPACT AIR ayex papr with bayonet connection	45
A150202	COMPACT AIR PLUS 系列卡口式接头电动送风系统 COMPACT AIR PLUS PAPR with bayonet connection	45
A150203	COMPACT AIR PLUS 系列卡口式接头电动送风系统 COMPACT AIR PLUS PAPR with threaded connection	45
A150050	AIRBELT 系列卡口式接头电动送风系统 AIRBELT PAPR with bayonet connection	45
A150051	AIRBELT 系列螺口式接头电动送风系统 AIRBELT PAPR with threaded connection	45
A160054-03	AIRBELT 配套使用P3滤芯, 每组3个 P3 filter for AIRBELT, 3pcs/package	45
A160050-23	压缩空气过滤装置 Compressed airline filter unit	47
86600	空气压缩机-美标款 (一人用) Ambient air pump - US standard (for one person)	47
86610	空气压缩机-美标款 (二人用) Ambient air pump - US standard (for two persons)	47
86620	空气压缩机-美标款 (三人用) Ambient air pump - US standard (for three persons)	47
PA101	Primair 头罩 Primair hood	49
PA111	Primair Plus 全覆盖型头罩 Primair Plus hood	49
PA121	Primair Plus 全覆盖型头罩, 防化学飞溅型 Primair Plus hood	49
A114106	JUNIOR A-vl 透风头罩 JUNIOR A-vl air hood	49
A114052	JUNIOR A-pl 透风头罩 JUNIOR A-pl air hood	49
A114300	JUNIOR A-Combi-vl 透风头罩 JUNIOR A-Combi-vl air hood	49
A114330	JUNIOR A-Combi-pl 透风头罩 JUNIOR A-Combi-pl air hood	49
A114400	JUNIOR B-vl 透风头罩 JUNIOR B-vl air hood	50
A114430	JUNIOR B-pl 透风头罩 JUNIOR B-pl air hood	50

订货号 Ref.	名称描述 Description	页码 Page
A114201	JUNIOR B-Combi-vl 透风头罩 JUNIOR B-Combi-vl air hood	50
A114230	JUNIOR B-Combi-pl 透风头罩 JUNIOR B-Combi-pl air hood	50
A130130-00	PANORAMA 喷砂头盔, 皮质披肩 Shotblasting helmet PANORAMA, with leather cape	51
A130230-00	PANORAMA 喷砂头盔, Bisonyl披肩 Shotblasting helmet PANORAMA, with Bisonyl cape	51
A133130-00	COMMANDER 喷砂头盔, 皮质披肩 Shotblasting helmet COMMANDER, with leather cape	51
A133230-00	COMMANDER 喷砂头盔, Bisonyl披肩 Shotblasting helmet COMMANDER, with Bisonyl cape	51
A161250	轻型供气软管-欧标款 (10米) Black, light duty air hose (10m)	52
A161253	重型供气软管-欧标款 (10米) Black, heavy duty air hose(10m)	52
A161254	重型供气软管-欧标款 (20米) Black, heavy duty air hose (20m)	52
A161255	重型供气软管-欧标款 (30米) Black, heavy duty air hose (30m)	52
A150275-01	Vortex涡流管和软管组合 Vortex air conditioner combined with air hose	52
888050	供气软管, 1/2"内径, 50英尺长 50' air hose, 1/2" I.D.	53
888100	供气软管, 1/2"内径, 100英尺长 100' air hose, 1/2" I.D.	53
88800H	快插式接头组合, 1/2"内径 Quick connection set, 1/2" I.D.	53
88800HV	涡流管, 1/2"内径 Vortex air conditioner, 1/2" I.D.	53
CF2007	长管适配器 Airline adapeter	53
7902	紧急逃生呼吸器, 可用于从含氯, 氯化氢, 硫化氢, 二氧化碳, 二氧化硫的大气中逃生 Emergency escape respirator to be used in Chlorine, Hydrogen Chloride, Sulfur Dioxide, Hydrogen Sulfide, Hydrogen Fluoride and Chlorine Dioxide	67
7904	紧急逃生呼吸器, 氨气防护 Emergency escape respirator to be used in ammonia	67
845	5分钟紧急逃生呼吸器, 平均每分钟42升 5 minute EEBA, 42L/min	68
850	10分钟紧急逃生呼吸器, 平均每分钟42升 10 minute EEBA, 42L/min	68
A168180	ER2000灾难预防和紧急逃生头罩 ER2000 emergency escape hood	67

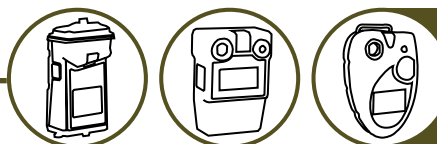

订货号 Ref.	名称描述 Description	页码 Page
54-40-30100A	Multi Vision LEL/O ₂ /CO 配碱性电电池 Multi Vision LEL/O ₂ /CO Alkaline gas detector	78
54-40-30102AV	Multi Vision™ O ₂ /CO/H ₂ S/LEL 碱性电池超值套装 Multi Vision™ O ₂ /CO/H ₂ S/LEL Alkaline Value Pack	78
54-40-30102NC	Multi Vision™ O ₂ /CO/H ₂ S/LEL 可充式电池完整包装 Multi Vision™ O ₂ /CO/H ₂ S/LEL Rechargeable Complete Kit	78
54-40-30200N	Multi Vision LEL/O ₂ /H ₂ S 配充电电电池 Multi Vision LEL/O ₂ /H ₂ S Nimh gas detector	78
54-44-01	ToxiLtd® 单一气体检测仪, 一氧化碳 ToxiLtd® Single-Sensor Gas Monitor, Carbon Monoxide	73
54-44-02	ToxiLtd® 单一气体检测仪, 硫化氢 ToxiLtd® Single-Sensor Gas Monitor, Hydrogen Sulfide	73
54-45-01	ToxiPro® 单一气体检测仪, 一氧化碳 ToxiPro® Single-Sensor Gas Monitor, Carbon Monoxide	73
54-45-02	ToxiPro® 单一气体检测仪, 硫化氢 ToxiPro® Single-Sensor Gas Monitor, Hydrogen Sulfide	73
54-45-90	ToxiPro® 单一气体检测仪, 氧气 ToxiPro® Single-Sensor Gas Monitor, Oxygen	73
54-46-9000	IQ Express™ 全自动检测标定仪 IQ Express™ Docking Station	74
54-46-9100N	IQ Express™ 全自动检测标定仪 IQ Express™ Docking Station	74
54-48-301A	MultiPro LEL/O ₂ /CO 复合式气体检测仪配碱性电电池 MultiPro LEL/O ₂ /CO with alkaline	77
54-48-302N	MultiPro LEL/O ₂ /H ₂ S 复合式气体检测仪配充电电电池 MultiPro LEL/O ₂ /H ₂ S with NI-LON include charger	77
54-48-314AV	MultiPro™ O ₂ /Duo-Tox (CO/H ₂ S)/LEL 碱性电池超值包装 MultiPro™ O ₂ /Duo-Tox (CO/H ₂ S)/LEL Alkaline Value Pack	77
54-48-314NC	MultiPro™ O ₂ /Duo-Tox (CO/H ₂ S)/LEL 可充电式电电池完整包装 MultiPro™ O ₂ /Duo-Tox (CO/H ₂ S)/LEL Rechargeable Complete Kit	77
54-49-9000	MultiPro™ IQ Express™ 全自动检测标定仪 MultiPro™ IQ Express™ Docking Station	77
54-49-9000N	MultiPro™ IQ Express™ 全自动检测标定仪 MultiPro™ IQ Express™ Docking Station	77
54-53-A140 08000AV	PHD6™ 密闭空间多气体检测仪 PHD6™ Confined Space Gas Monitor	75
54-53-A010 25280N	PHD6™ 密闭空间多气体检测仪 PHD6™ Confined Space Gas Monitor	75
54-53-A010 25080N	PHD6™ 密闭空间多气体检测仪 PHD6™ Confined Space Gas Monitor	75
54-53-A140 05100NC	PHD6™ 密闭空间多气体检测仪 PHD6™ Confined Space Gas Monitor	75

订货号 Ref.	名称描述 Description	页码 Page
54-54-9200	IQ6™ 全自动检测标定仪 IQ6™ Docking Station	76
54-54-9200N	IQ6™ 全自动检测标定仪 IQ6™ Docking Station	76
54-34- 30102N	Cannonball3™ 多气体检测仪 Cannonball3™ Multi-Sensor Gas Monitor	76
54-35- 30102N	Cannonball3™ 多气体检测仪 Cannonball3™ Multi-Sensor Gas Monitor	76
54-55-010	NXP™ 固定式气体检测仪 NXP™ Fixed Gas Monitor	79
54-55-020	NXP™ 固定式气体检测仪 NXP™ Fixed Gas Monitor	79
54-55-190	NXP™ 固定式气体检测仪 NXP™ Fixed Gas Monitor	79
54-55-900	NXP™ 固定式气体检测仪 NXP™ Fixed Gas Monitor	79
54-62-010	EXP™ 固定式气体检测仪 EXP™ Fixed Gas Monitor	79
54-62-020	EXP™ 固定式气体检测仪 EXP™ Fixed Gas Monitor	79
54-62-800	EXP™ 固定式气体检测仪 EXP™ Fixed Gas Monitor	79
54-62-190	EXP™ 固定式气体检测仪 EXP™ Fixed Gas Monitor	79
54-62-900	EXP™ 固定式气体检测仪 EXP™ Fixed Gas Monitor	79
54-50- 331NH0	TravelPanel™ 50MP 便携式空气过滤系统	80
54-50- 300NH1	TravelPanel™ 50MP 便携式空气过滤系统	80
54-50- 331NH3B	TravelPanel™ 50MP 便携式空气过滤系统	80
54-50- 100NS0	TravelPanel™ 50MP 便携式空气过滤系统	80
54-56-1117	Posi 3 USB™ SCBA 呼吸器检测仪 Posi 3 USB™ SCBA Performance Testers	81
54-56-1117-L	Posi 3 USB™ SCBA 呼吸器检测仪 Posi 3 USB™ SCBA Performance Testers	81
54-56-2117	Posi 3 USB™ SCBA 呼吸器检测仪 Posi 3 USB™ SCBA Performance Testers	81
54-56-2117-L	Posi 3 USB™ SCBA 呼吸器检测仪 Posi 3 USB™ SCBA Performance Testers	81
54-21-09	Posi 3 USB™ SCBA 呼吸器检测仪 Posi 3 USB™ SCBA Performance Testers	81
54-21-10	Posi 3 USB™ SCBA 呼吸器检测仪 Posi 3 USB™ SCBA Performance Testers	81



订货号 Ref.	名称描述 Description	页码 Page
2000044	焊接手套 BLUE WELDING	98
2012847	进口皮革焊接隔热手套 FOUNDRY LINED	98
2032101CN	贴皮KEVLAR® 耐磨防割手套 JUNKYARD DOG	91
2058685	高性能防冻手套 CRYOGENIC	102
2058698	镀铝皮革焊接隔热手套 右手 ATLANTIC WELDING Right Hand	98
2058699	镀铝皮革焊接隔热手套 左手 ATLANTIC WELDING Left Hand	98
2094140CN	天然乳胶涂层工作手套 DEXGRIP	87
2094831	丁腈防化手套 POWERCOAT™ 948-31 NITRAF	93
2095020	氯丁橡胶轻型防化手套 POWERCOAT™ 950-20 NEOFIT	93
2095025	氯丁橡胶防化长手套 POWERCOAT™ 950-25NEOFIT	93
2100250CN	尼龙PU涂层耐磨工作手套 灰色 PU First Grey	88
2100251CN	涤纶PU涂层耐磨工作手套 Workeasy Black Black	88
2132255CN	尼龙PU涂层耐磨工作手套 白色 PU First white	88
2232240CN	尼龙指浸PU白色分类工作手套 Perfect Poly® Finger	89
2201336	KERMEL® 高性能隔热手套 TOPFIRE KERMEL	99
2232230CN	尼龙丁腈涂层耐油工作手套 POLYTRIL™	89
2232233CN	丁腈涂层耐油防割防滑工作手套 Polytril Mix	87
2232244	Dyneema® 防割手套 PERFECT CUTTING WHITE	91
2232270CN	尼龙发泡丁腈涂层耐油防滑工作手套 POLYTRIL™ AIR	89
2032625CN	毛圈棉隔热防护手套 短袖 TERRY MIX	100
2232635CN	毛圈棉隔热防护手套 长袖 TERRY LONG	100

订货号 Ref.	名称描述 Description	页码 Page
2232688	KEVLAR®耐高温手套 ARATHERMA COMFORT TERRY	100
2233025CN	尼龙点塑防割手套 ABRATEX GRIP	92
2275112	ZETEX®高性能隔热手套 SUPERZETEX	99
2280673	SUPERTHERMA KEVLAR®高性能隔热手套 SUPERTHERMA	99
2281561	进口消防员手套 FIREMAN	101
250000XR 0302	金属防割手套 CHAINEX METAL MESH GLOVE	92
4402835CN	KEVLAR® 防割耐热护臂 ARACUT SLEEVE	92
2232092CN	双面点塑防滑工作手套 RESISTEX GRIP 2	87
2232522CN	高性能复合材质防割手套 So Cut Extra Pro	90
2132245CN	新一代迪尼玛®防割手套 Perfect Cutting Grey First	90
52/6647	KEVLAR®丁腈点塑防割手套 KEVLAR®NITRILE COATED KEVLAR GLOVES	91
LA102G	无衬丁腈手套 NITRI GUARD PLUS	94
LA132G	无衬丁腈手套 NITRI GUARD PLUS	94
LA172G	无衬丁腈手套 NITRI GUARD PLUS	94
LA258G	无衬丁腈手套 NITRI GUARD PLUS	94
NK803	带衬丁腈手套 NITRI KNIT	94
NK803IN	带衬丁腈手套 NITRI KNIT	94
NK803ES	长袖带衬丁腈手套 NITRI KNIT, long sleeve	94
PNLB1815/Q	无衬天然橡胶手套 Nature Rubber	95
850FWG	重型带衬PVC手套 TRAWLER KING	95
B131R	丁基橡胶无衬手套 NORTH BUTYL	96
B161R	丁基橡胶无衬手套 NORTH BUTYL	96
B174	丁基橡胶无衬手套 NORTH BUTYL	96

订货号 Ref.	名称描述 Description	页码 Page
B324	丁基橡胶无衬手套 NORTH BUTYL	96
SSG	复合膜防化手套 SLIVER SHIELD/4H	96
SSG29	复合膜防化手套, 长袖 SLIVER SHIELD/4H, long sleeve	96
LA049PF	检查和工业级丁腈抛弃型手套 DEXI-TASK	97
LA049IND	检查和工业级丁腈抛弃型手套 DEXI-TASK	97
T425PF	检查级天然橡胶抛弃型手套 SENSI-TASK	97
T525	检查级乙烯抛弃型手套 VINYL-TASK	97
51/7147	丁腈涂层耐高温手套 GRIP N Hot Mill	101
70/6465NK	皮质手掌耐低温手套 NORTH POLAR	102
HP100MY	100级洁净室天然橡胶抛弃型手套 CLEANROOM LATEX DISPOSABLE GLOVE	103
CE412W	100级洁净室丁腈抛弃型手套 CLEANROOM NITRILE DISPOSABLE GLOVE	103
ATCP1815/O	无衬天然橡胶手套 ANTIC	104
AK1815/O	AK洁净室天然橡胶防化手套 CLEANROOM LATEX GLOVE	104
7B1532	丁基合成橡胶干箱手套 BUTYL GLOVEBOX GLOVE	105
7B1532A	丁基合成橡胶干箱手套 BUTYL GLOVEBOX GLOVE	105
8B1532	丁基合成橡胶干箱手套 BUTYL GLOVEBOX GLOVE	105
8B1532A	丁基合成橡胶干箱手套 BUTYL GLOVEBOX GLOVE	105
7B3032	丁基合成橡胶干箱手套 BUTYL GLOVEBOX GLOVE	105
7B3032A	丁基合成橡胶干箱手套 BUTYL GLOVEBOX GLOVE	105
8B3032	丁基合成橡胶干箱手套 BUTYL GLOVEBOX GLOVE	105
8B3032A	丁基合成橡胶干箱手套 BUTYL GLOVEBOX GLOVE	105
7N1532	氯丁橡胶干箱手套 NEOPRENE GLOVEBOX GLOVE	106
7N1532A	氯丁橡胶干箱手套 NEOPRENE GLOVEBOX GLOVE	106

订货号 Ref.	名称描述 Description	页码 Page
8N1532	氯丁橡胶干箱手套 NEOPRENE GLOVEBOX GLOVE	106
8N1532A	氯丁橡胶干箱手套 NEOPRENE GLOVEBOX GLOVE	106
7N3032	氯丁橡胶干箱手套 NEOPRENE GLOVEBOX GLOVE	106
7N3032A	氯丁橡胶干箱手套 NEOPRENE GLOVEBOX GLOVE	106
8N3032	氯丁橡胶干箱手套 NEOPRENE GLOVEBOX GLOVE	106
8N3032A	氯丁橡胶干箱手套 NEOPRENE GLOVEBOX GLOVE	106
10N3032A	氯丁橡胶干箱手套 NEOPRENE GLOVEBOX GLOVE	106
8NY3032	氯丁橡胶/Hypalon®材料干箱手套 Hypalon®/NEOPRENE GLOVEBOX GLOVE	107
8NY3032A	氯丁橡胶/Hypalon®材料干箱手套 Hypalon®/NEOPRENE GLOVEBOX GLOVE	107
7NY3032	氯丁橡胶/Hypalon®材料干箱手套 Hypalon®/NEOPRENE GLOVEBOX GLOVE	107
7NY3032A	氯丁橡胶/Hypalon®材料干箱手套 Hypalon®/NEOPRENE GLOVEBOX GLOVE	107
7Y1532	Hypalon®材料干箱手套 Hypalon® GLOVEBOX GLOVE	108
7Y1532A	Hypalon®材料干箱手套 Hypalon® GLOVEBOX GLOVE	108
8Y1532	Hypalon®材料干箱手套 Hypalon® GLOVEBOX GLOVE	108
8Y1532A	Hypalon®材料干箱手套 Hypalon® GLOVEBOX GLOVE	108
10Y1532A	Hypalon®材料干箱手套 Hypalon® GLOVEBOX GLOVE	108
7Y3032	Hypalon®材料干箱手套 Hypalon®GLOVEBOX GLOVE	108
8Y3032	Hypalon®材料干箱手套 Hypalon® GLOVEBOX GLOVE	108
8Y3032A	Hypalon®材料干箱手套 Hypalon®GLOVEBOX GLOVE	108
8NLL3032	加铅氯丁橡胶干箱手套 LEAD-LOADED NEOPRENE GLOVEBOX GLOVE	109
8NLL3032A	加铅氯丁橡胶干箱手套 LEAD-LOADED NEOPRENE GLOVEBOX GLOVE	109
7NLL3032	加铅氯丁橡胶干箱手套 LEAD-LOADED NEOPRENE GLOVEBOX GLOVE	109
8NLY3032	Hypalon®加铅氯丁橡胶干箱手套 LEAD-LOADED Hypalon®- NEOPRENE	110

订货号 Ref.	名称描述 Description	页码 Page
8NLY3032A	Hypalon®加铅氯丁橡胶干箱手套 LEAD-LOADED Hypalon®- NEOPRENE	110
7NLY3032	Hypalon®加铅氯丁橡胶干箱手套 LEAD-LOADED Hypalon®- NEOPRENE	110
7NLY3032A	Hypalon®加铅氯丁橡胶干箱手套 LEAD-LOADED Hypalon®- NEOPRENE	110
8YLY3032	加铅Hypalon®材料干箱手套 LEAD-LOADED Hypalon®GLOVEBOX GLOVE	111
8YLY3032A	加铅Hypalon®材料干箱手套 LEAD-LOADED Hypalon® GLOVEBOX GLOVE	111
7YLY3032	加铅Hypalon®材料干箱手套 LEAD-LOADED Hypalon® GLOVEBOX GLOVE	111
7YLY3032A	加铅Hypalon®材料干箱手套 LEAD-LOADED Hypalon® GLOVEBOX GLOVE	111
N103A	短款氯丁橡胶干箱手套 NEOPRENE SHORT GLOVEBOX GLOVE	112
N204A	短款氯丁橡胶干箱手套 NEOPRENE SHORT GLOVEBOX GLOVE	112
Y103	短款Hypalon®材料干箱手套 Hypalon® SHORT GLOVEBOX GLOVE	113
Y103A	短款Hypalon®材料干箱手套 Hypalon® SHORT GLOVEBOX GLOVE	113
Y154A	短款Hypalon®材料干箱手套 Hypalon®SHORT GLOVEBOX GLOVE	113
Y254A	短款Hypalon®材料干箱手套 Hypalon® SHORT GLOVEBOX GLOVE	113
YSL2027	Hypalon®护袖 Hypalon® SLEEVES	114
8LA1832	丁腈干箱手套 NITRILE GLOVEBOX GLOVE	114
10LA1832	丁腈干箱手套 NITRILE GLOVEBOX GLOVE	114

防护服系列
Protective Clothing



115 - 130

订货号 Ref.	名称描述 Description	页码 Page
1410003	镀铝隔热鞋罩 Aluminised heat resistant shoe cover	120
1410113	镀铝隔热长风衣 Aluminized Heat Resistant Coat	119
1410155	镀铝隔热头罩 Aluminised heat resistant helmet	120

订货号 Ref.	名称描述 Description	页码 Page
4111831-P	AIR PLUME 避火隔热服 Fire protective clothing-AIR PLUME	118
4111839-S-P	B2 避火隔热服-S B2 Fire Protective Clothing-S	117
4111839-M-P	B2 避火隔热服-M B2 Fire Protective Clothing-M	117
4571433	MS 3.5.6轻型防化服 MS 3.5.6 Chemical protective clothing	126
8527339	核防护类通风头罩 Nuclear protective helmet	128
1400021-S-40	重型防化服(内置式)-S-40 Heavy Chemical protective clothing with SCBA inside	121
1400021-M-42	重型防化服(内置式)-M-42 Heavy Chemical protective clothing with SCBA inside	121
1400021-M-44	重型防化服(内置式)-M-44 Heavy Chemical protective clothing with SCBA inside	121
1400021-L-44	重型防化服(内置式)-L-44 Heavy Chemical protective clothing with SCBA inside	121
1400021-XL-44	重型防化服(内置式)-XL-44 Heavy Chemical protective clothing with SCBA inside	121
1400020-S-40	EasyChem 外置式重型防化服-S-40 EasyChem Heavy chemical protective clothing with SCBA outside	121
1400020-M-42	EasyChem 外置式重型防化服-M-42 EasyChem Heavy chemical protective clothing with SCBA outside	121
1400020-M-44	EasyChem 外置式重型防化服-M-44 EasyChem Heavy chemical protective clothing with SCBA outside	121
1400020-L-44	EasyChem 外置式重型防化服-L-44 EasyChem Heavy chemical protective clothing with SCBA outside	121
1400020-XL-44	EasyChem 外置式重型防化服-XL-44 EasyChem Heavy chemical protective clothing with SCBA outside	121
1410F	镀铝隔热上衣S号 Aluminized kevlar 370K jacket K900,S	119
1410F34.052	镀铝隔热上衣M号 Aluminized kevlar 370K jacket K900,S	119
1410F34.056	镀铝隔热上衣L号 Aluminized kevlar 370K jacket K900,S	119
1410F34.060	镀铝隔热上衣XL号 Aluminized kevlar 370K jacket K900,S	119
1410F35.048	镀铝隔热下装S号 Aluminized kevlar 370K TROUSERS K901,S	119
1410F35.052	镀铝隔热下装M号 Aluminized kevlar 370K TROUSERS K901,S	119
1410F35.056	镀铝隔热下装L号 Aluminized kevlar 370K TROUSERS K901,S	119
1410F35.060	镀铝隔热下装XL号 Aluminized kevlar 370K TROUSERS K901,S	119

订货号 Ref.	名称描述 Description	页码 Page
4102334-42-P	B1PU 避火隔热服 B1 PU Fire Protective Clothing	117
4180149-03	SPACEL PLUS 3000 (164cm-176cm)	124
4180149-04	SPACEL PLUS 3000 (176cm-188cm)	124
4180149-05	SPACEL PLUS 3000 (188cm-200cm)	124
4481211-01	核防护类通风气衣 (164cm-170cm) Nuclear protective clothing (164cm-170cm)	128
4481212-02	核防护类通风气衣 (170cm-176cm) Nuclear protective clothing (170cm-176cm)	128
4481213-03	核防护类通风气衣 (176cm-182cm) Nuclear protective clothing (176cm-182cm)	128
4481214-04	核防护类通风气衣 (182cm-188cm) Nuclear protective clothing (182cm-188cm)	128
AP4571450	DS201一次性防护服 DS201 Light chemical protective clothing	125
941001	DS202一次性防护服 DS202 Light chemical protective clothing	125
941002	DS203一次性防护服 DS203 Light chemical protective clothing	125
A145110	氟橡胶/丁基橡胶气密型化学防护服 RINBA® Defender, Gas Tight Chemical Protective Suit	122
A140340	氯丁橡胶气密型化学防护服 RINBA® Partol, Gas Tight Chemical Protective Suit	122
A164223	喷雾致密型和液体致密型一体式防护服 RINBA® Guardian Plus. Liquid/Spray Tight Chemical Protective Suit	123
A163332	喷雾致密型化学防护服 RINBA® FERRANYL, Spray Tight Chemical Protective Suit	123
A163731	喷雾致密型化学防护服 RINBA® FERRANYL, Spray Tight Chemical Protective Suit	123
A164856	喷雾致密型化学防护服 RINBA® FERRANYL, Spray Tight Chemical Protective Suit	123
A164141	喷雾致密型化学防护服 RINBA® FERRANYL, Spray Tight Chemical Protective Suit	123
N71254110	喷雾致密型化学防护服 Boiler Suit	124
N71254210	喷雾致密型化学防护服 Boiler Suit	124
A164380	通用PVC一体式防护服 RINBA® Splash, Liquid Tight Coverall Splash	124
85596	抛弃型连体防护服 GEN "AIR" coverall	126
35596/ 35596W	抛弃型连体防护服 GEN "PRO" coverall	126

订货号 Ref.	名称描述 Description	页码 Page
A164450	RINBA® 皮质防护服 RINBA® Leather Coverall	127

足部防护系列
Foot Protection



131 - 142

订货号 Ref.	名称描述 Description	页码 Page
BC0828101	GRANT 防静电保护足趾安全鞋 GRANT anti-atic,anti-impact safety shoes	136
BC0828102	GRANT 防静电保护足趾防刺穿猪皮鞋垫安全鞋 GRANT anti-atic,anti-impact,anti-perforation leather insole safety shoes	136
BC0919701	ECO 防静电保护足趾安全鞋 ECO anti-atic,anti-impact safety shoes	134
BC0919702	ECO 保护足趾电绝缘安全鞋 ECO anti-impact,electrical insulating safety shoes	134
BC0919703	ECO 防静电保护足趾防刺穿安全鞋 ECO anti-atic,anti-impact,anti-perforation safety shoes	134
SP2010500	Tripper 防静电安全鞋, 灰色 Tripper anti-atic safety shoes, grey	133
SP2010501	Tripper 防静电保护足趾安全鞋, 灰色 Tripper anti-atic,anti-impact safety shoes,grey	133
SP2010502	Tripper 防静电保护足趾防刺穿安全鞋, 灰色 Tripper anti-atic,anti-impact,anti-perforation safety shoes, grey	133
SP2010503	Tripper 电绝缘安全鞋, 灰色 Tripper 6000V electrical insulation, grey	133
SP2010510	Tripper 防静电安全鞋, 红色 Tripper anti-atic safety shoes, red	133
SP2010511	Tripper 防静电保护足趾安全鞋, 红色 Tripper anti-atic,anti-impact safety shoes, red	133
SP2010512	Tripper 防静电保护足趾防刺穿安全鞋, 红色 Tripper anti-atic,anti-impact,anti-perforation safety shoes, red	133
SP2010513	Tripper 电绝缘安全鞋, 红色 Tripper 6000V electrical insulation, red	133
SP2010901	Lancer 防静电保护足趾安全鞋, 灰色 Lancer anti-atic,anti-impact safety shoes,grey	134
SP2010902	Lancer 防静电保护足趾防刺穿安全鞋, 灰色 Lancer anti-atic,anti-impact,anti-perforation safety shoes, grey	134
SP2010903	Lancer 电绝缘安全鞋, 灰色 Lancer 6000V electrical insulation, grey	134
SP2010911	Lancer 防静电保护足趾安全鞋, 米色 Lancer anti-atic,anti-impact safety shoes,beige	134
SP2010912	Lancer 防静电保护足趾防刺穿安全鞋, 米色 Lancer anti-atic,anti-impact,anti-perforation safety shoes, beige	134

订货号 Ref.	名称描述 Description	页码 Page
SP2010913	Lancer 电绝缘安全鞋, 米色 Lancer 6000V electrical insulation, beige	134
BC6240122B	RALLYE 防静电保护足趾防刺穿安全靴 RALLYE anti-atic,anti-impact,anti-perforation safety boot	137
BC6240124B	RALLYE B防静电保护足趾防刺穿保暖内衬安全靴, 黑色牛皮 RALLYE B anti-atic,anti-impact,anti-perforation, warm lining safety boot	137
SP2011300	Rider 防静电安全鞋, 低帮 Rider anti-atic safety shoes, low cut	133
SP2011301	Rider 防静电保护足趾安全鞋, 低帮 Rider anti-atic,anti-impact safety shoes, low cut	133
SP2011302	Rider 防静电保护足趾防刺穿安全鞋, 低帮 Rider anti-atic,anti-impact,anti-perforation safety shoes, low cut	133
SP2011303	Rider 电绝缘安全鞋, 低帮 Rider 6000V electrical insulation, low cut	133
SP2011310	Rider 防静电安全鞋, 中帮 Rider anti-atic safety shoes, middle cut	133
SP2011311	Rider 防静电保护足趾安全鞋, 中帮 Rider anti-atic,anti-impact safety shoes, middle cut	133
SP2011312	Rider 防静电保护足趾防刺穿安全鞋, 中帮 Rider anti-atic,anti-impact,anti-perforation safety shoes, middle cut	133
SP2011313	Rider 电绝缘安全鞋, 中帮 Rider 6000V electrical insulation, middle cut	133
BC6242121	Racing 防静电保护足趾安全鞋 Racing anti-atic,anti-impact safety shoes	135
BC6242122	Racing 防静电保护足趾防穿刺安全鞋 Racing anti-atic,anti-impact,anti-perforation safety shoes	135
BC6242124	Racing 保护足趾电绝缘安全鞋 Racing anti-impact,electrical insulating safety shoes	135
BC6240225	COLT 防静电保护足趾安全鞋 COLT anti-atic,anti-impact safety shoes	135
BC6240226	COLT 防静电保护足趾防穿刺安全鞋 COLT anti-atic,anti-impact,anti-perforation safety shoes	135
BC6245227	COLT 保护足趾电绝缘安全鞋 COLT anti-impact,electrical insulating safety shoes	135
BC6240470	GLOBE 防静电保护足趾安全鞋 GLOBE anti-atic,anti-impact safety shoes	136
BC6240471	GLOBE 防静电保护足趾防穿刺安全鞋 GLOBE anti-atic,anti-impact,anti-perforation safety shoes	136
BC6240475	GLOBE 保护足趾电绝缘安全鞋 GLOBE anti-impact,electrical insulating safety shoes	136
BC6240474	GLOBE 防静电保护足趾安全鞋, 保暖内衬 GLOBE anti-atic,anti-impact safety shoes, Warm lining	136
BC6240476	GLOBE 防静电保护足趾防穿刺安全鞋, 保暖内衬 GLOBE anti-atic,anti-impact,anti-perforation safety shoes, Warm lining	136
BC6240478	GLOBE 保护足趾电绝缘安全鞋, 保暖内衬 GLOBE anti-impact,electrical insulating safety shoes, Warm lining	136

订货号 Ref.	名称描述 Description	页码 Page
22148	氯丁橡胶安全防护靴 NEOPRENE Boot	137
22206	氯丁橡胶安全防护靴 NEOPRENE Boot	137
75109	TDT® 三重密度注塑防化靴 XTP Safety Hi Boot	138
75145C	PVC 高筒防护靴 PRM PVC Safety Hi Boot	138
18821	CT™高筒经济型防护靴 CT™ Economy Hi Boot	138
73104	Iron Duke®复合高聚物防护短靴 Iron Duke® Polyblend PVC 5-Eyelet Safety Shoe	139
11003	SF防滑靴套 SF Slip-On Overboot	139
11095	SF 中筒防护靴套 Superfit Chem Mid Hight Overboot	139
NMX880	重型工矿靴 Heavy duty boot	140
R6130	电力伤害防护靴 Ranger Dielectric Safety Mid Pac	140
A422	皮质靴面双重保暖中筒派克靴 Double Insulated Leather Top Mid Pac	141
A421	皮质靴面保暖中筒派克靴 Leather Top Mid Pac	141
A521	皮质靴面保暖中筒派克靴 Leather Top Mid Pac	141
A531	翻皮靴面保暖中筒派克靴 Suedu Leather Top Mid Pac	142
RJX	消防战斗靴 Fire fighter boot	142

坠落防护系列
Fall Protection

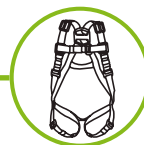

143 - 168

订货号 Ref.	名称描述 Description	页码 Page
10 148 07	Revolution R7 风电专用安全带，配有定位腰带-S/M Revolution R7 Wind Energy Harness-S/M	145
10 148 08	Revolution R7 风电专用安全带，配有定位腰带-L/XL Revolution R7 Wind Energy Harness-L/XL	145
10 156 03	Revolution R8 风电专用安全带，配有定位腰带-S/M Revolution R8 Wind Energy Harness-S/M	145
10 156 04	Revolution R8 风电专用安全带，配有定位腰带-L/XL Revolution R8 Wind Energy Harness-L/XL	145

订货号 Ref.	名称描述 Description	页码 Page
10 028 27	MightyLite™ 坠落制动器 6.2米 MightyLite™ Fall arrest block 6.2m	156
10 028 49	Duraflex® 双挂点全身安全带 DuraFlex 2-point Harness	146
10 028 51	三挂点标准型全身安全带 3-Point Standard Harness	147
10 028 53	Duraflex® 三挂点全身安全带 DuraFlex® 3-point Harness	146
10 028 57	Duraflex® 三挂点全身安全带, 配有定位腰带 DuraFlex® 3-point Harness with Positioning Belt	146
10 028 68	MG00钢缆抓绳器 MG00 MicroLoc Cable Grab	159
10 028 71	ML20 ML20	155
10 028 75	抓绳器 Rope Grab	159
10 028 76	抓绳器 Rope Grab	159
10 028 82	定位腰带 Work positioning belt	160
10 028 91	安全绳 (10米) Rope (10m)	160
10 028 92	安全绳 (20米) Rope (20m)	160
11 028 93	安全绳 (30米) Rope (30m)	160
12 028 94	安全绳 (40米) Rope (40m)	160
13 028 95	安全绳 (50米) Rope (50m)	160
10 028 81	限位系绳 Restraint Lanyard	153
10 034 38	RM全身式安全带 RM Full-body Harness	149
10 029 07	缓冲系带 Shock-absorbing Lanyard	152
10 045 12	安全绳 Rope	160
10 045 90	缓冲系带 Shock-absorbing Lanyard	152
10 045 91	缓冲系绳 Shock-absorbing Lanyard	152
10 045 71	MightyLite™ 坠落制动器 10米 MightyLite™ Fall arrest block 10m	156
10 045 72	MightyLite™ 坠落制动器 20米 MightyLite™ Fall arrest block 20m	156
10 045 74	MightyLite™ 坠落制动器 30米 MightyLite™ Fall arrest block 30m	156

订货号 Ref.	名称描述 Description	页码 Page
10 045 75	MightyLite™ 坠落制动器 40米 MightyLite™ Fall arrest block 40m	156
10 045 94	MightyLite™ 坠落制动器 30米, 不锈钢缆 MightyLite™ Fall arrest block 30m, Stainless steel wire	156
10 045 95	MightyLite™ 坠落制动器 40米, 不锈钢缆 MightyLite™ Fall arrest block 40m, Stainless steel wire	156
10 050 41	三脚架 Tripod	164
10 050 42	绞盘 Winch	164
10 053 18	Manyard™ 系带 Manyard™ Lanyard	150
10 053 25	Manyard™ 系带 Manyard™ Lanyard	150
10 060 26	INDY 救援套件 INDY Rescue kit	164
10 061 00	MiniLite™ 系列坠落制动器 MiniLite™ Fall Limiter	155
10 061 01	MiniLite™ 系列坠落制动器 MiniLite™ Fall Limiter	155
10 061 02	MiniLite™ 系列坠落制动器 MiniLite™ Fall Limiter	155
10 070 22	IBX2R 全身式安全带 IBX2R Full-body Harness	149
10 070 46	Evac 轻型救援担架 Evac Body Splint	164
10 082 82	缓冲包 Shock-absorbing pack	161
10 101 41	Barracuda™ 脚手架缓冲系绳 Barracuda™ Scaffolding Lanyard	153
10 102 52	RAM 救援坐带 RAM Sit Harness	149
10 118 90	单挂点标准型全身安全带 1-point Standard Harness	147
10 118 91	双挂点标准型全身安全带 2-point Standard Harness	147
10 118 94	双挂点标准型全身安全带, 配有定位腰带 2-point Standard Harness with Positioning Belt	147
10 167 94	Falcon™ 坠落制动器 Falcon™ fall arrest block	157
10 167 95	Falcon™ 坠落制动器 Falcon™ fall arrest block	157
10 167 96	Falcon™ 坠落制动器 Falcon™ fall arrest block	157
10 189 60	安全钩 Karabiner	161
10 189 69	安全钩 Karabiner	161

订货号 Ref.	名称描述 Description	页码 Page
10 189 71	安全钩 Karabiner	162
10 189 77	脚手架挂钩 Scaffold Hook	161
10 287 56	SafEscape ELITE 逃生装置 80米 SafEscape ELITE Automatic Descent Device 80m	163
10 287 58	SafEscape ELITE 逃生装置 100米 SafEscape ELITE Automatic Descent Device 100m	163
10 287 75	SafEscape ELITE 救援逃生装置 80米 SafEscape ELITE Automatic Rescue / Descent Device 80m	163
10 287 77	SafEscape ELITE 救援逃生装置 100米 SafEscape ELITE Automatic Rescue / Descent Device 100m	163
751K/UBLU	焊工工全身式安全带 Welder Full-body Harness	162
8798B-SN	BackBiter® 双叉型缓冲系带 BackBiter® Shock-absorbing Lanyard	151
907K/6FTBL	焊工工缓冲系绳 1.8米 Welder shock-absorbing lanyard 1.8m	162
913B-SN	BackBiter® 缓冲系带 BackBiter® Shock-absorbing Lanyard	151
CFL-2	Black Rhino™ 坠落制动器 Black Rhino™ Self-retracting lifeline 2.7m	158
DL-20	工作定位腰带 Work positioning belt	161
DL-25	工作定位系绳 2米 Work positioning lanyard 2m	160
DL-30	单挂点经济型全身安全带 1-Point Value Harness	148
DL-31	双挂点经济型全身安全带 2-Point Value Harness	148
DL-35	双挂点经济型全身安全带,配有定位腰带 2-Point Value Harness with Positioning Belt	148
DL-C1	单挂点集成式全身安全带 1-Point Value Harness with Shock-Absorbing Lanyard	148
DL-50	缓冲系带 Shock-absorbing Lanyard	152
DL-51	缓冲系带 Shock-absorbing Lanyard	152
DL-55	限位系绳 Restraint Lanyard	153
DL-56	限位系绳 Restraint Lanyard	153
MFL-1/6FT	Turbolite™ 系列坠落制动器 Turbolite™ Self-retracting Lifeline	154
MFL-2/6FT	Turbolite™ 系列坠落制动器 Turbolite™ Self-retracting Lifeline	154
MFL-3/6FT	Turbolite™ 系列坠落制动器 Turbolite™ Self-retracting Lifeline	154

订货号 Ref.	名称描述 Description	页码 Page
MP20G/20FT	Falcon™ 坠落制动器 6.2米 Falcon™ fall arrest block 6.2m	157
MP30G/30FT	Falcon™ 坠落制动器 10米 Falcon™ fall arrest block 10m	157
RL175G/175FT	MightyLite™ 坠落制动器 54米 MightyLite™ Fall arrest block 54m	156
10 029 17	锚点吊带 (0.8米) Anchorage Sling (0.8m)	161
10 029 19	锚点吊带 (1.5米) Anchorage Sling (1.5m)	161
10 043 24	安全钩 Karabiner	162

电力防护系列
Electrical Safety Protection



169 - 174

订货号 Ref.	名称描述 Description	页码 Page
2012898	绝缘手套外用防护手套(中低压)00级/0级/1级 Overglove MT (Class 1)	173
2012899	绝缘手套外用防护手套(高压)2级/3级 Overglove HT (Class 2 and 3)	173
2091903	天然乳胶切边绝缘手套, 工作电压500伏 Electrosoft 500V 00 G	173
2091907	天然乳胶切边绝缘手套, 工作电压1000伏 Electrosoft 1000V 00 G	173
2091908	天然乳胶卷边绝缘手套, 工作电压1000伏 Electrosoft 1000V 0 G	173
2091912	天然乳胶切边绝缘手套, 工作电压7500伏 Electrosoft 7500V 1 G	173
2091913	天然乳胶卷边绝缘手套, 工作电压7500伏 Electrosoft 7500v 1 G	173
2091921	天然乳胶切边绝缘手套, 工作电压17000伏 Electrosoft 17000V 2 G	173
2091931	天然乳胶切边绝缘手套, 工作电压26500伏 Electrosoft 126500V 3 G	173
2091922	天然乳胶切边绝缘手套, 工作电压17000伏 Electrosoft 17000V 2 G	173
2091941	天然乳胶切边绝缘手套, 工作电压36000伏 Electrosoft 36000V 4 G	173
2092015	复合材质绝缘手套, 工作电压1000伏 Electrosoft Composite Glove 1000V	174
2092017	复合材质绝缘手套, 工作电压7500伏 Electrosoft Composite Glove 7500V	174

订货号 Ref.	名称描述 Description	页码 Page
2092027	复合材质绝缘手套, 工作电压17000伏 Electrosoft Composite Glove 17000V	174
AS1000HAT	防电弧头盔 Arc Flash Protection Helmet	171
AS1000FS	防电弧面屏 Arc Flash Protection Visor	171
SKJP11	12 cal/cm2电弧防护套件 12 cal/cm2 Arc Flash Protection Sets	171
SKJP8	8 cal/cm2电弧防护套件 8 cal/cm2 Arc Flash Protection Sets	171
SK40L	PRO-WEAR™个人防护装备套件 PRO-WEAR™	172

消防救援系列
First Responder Products



175 - 180

订货号 Ref.	名称描述 Description	页码 Page
HT-LF2-BPR	Lite Force Plus消防战斗头盔 Lite Force Plus Modern Helmet	177
HT-BF2- Prox(BPR)	Proximity消防隔热头盔 Proximity Plus Helmet Lite Force with BPR	177
UT-UHD	抢险救援头盔 Technical Rescue Helmet	177
GL-7500	消防战斗手套 Structural Glove	177
GL-SGKCG	消防战斗手套 Structural Glove	178
GL-9500	消防战斗手套 Structural Glove	178
GL-BPR-RGA	消防隔热手套 Pr-oximity Glove	178
FG-1000	消防员灭火防护服 Structural Apparel	179
RNG-3400	消防灭火战斗防护服 Structural Apparel	179
7602	消防隔热防护服 Morning Pride Proximity	179
3104	消防战斗靴 Ranger Traditional fit	180
3009	消防战斗靴 Structural Boots	180
RJX	消防战斗靴 Structural Boots of GA Standard	180
6221	消防隔热救援靴 ARFF Bunker Boots	180

服务全心全意 品质精益求精

上海山合海融商贸有限公司

<http://www.shhairong.cn>

<http://www.51082245.cn>

<http://www.51082245.com>

E-mail : sh@51082245.com

电话 : 021-51082245

传真 : 021-56889347

QQ : 1742312421

MSN : shhairong@hotmail.com

贸易通 : lzzsbj